



Fwd: [IJRES] Submission Acknowledgement

1 message

Amar Vijai <amarvijai01@ulm.ac.id>
To: Nurma Sari <nurmasari01@ulm.ac.id>

Thu, Jul 20, 2023 at 11:53 AM

Ini sdh ulun upload
Klo pian mau cek ada link alamat, username n psswrn dibawah

Amar

Begin forwarded message:

From: Selvakumar Manickam <ijres@iaesjournal.com>
Date: 20 July 2023 14.47.28 GMT+8
To: Amar Nasrulloh <amarvijai01@ulm.ac.id>
Subject: [IJRES] Submission Acknowledgement
Reply-To: "" <>

Dear Prof/Dr/Mr/Mrs. Amar Nasrulloh,

Thank you for submitting the manuscript, "Design of IoT-based Monitoring System for Temperature and Dissolved Oxygen Levels in Catfish Aquaculture Pond Water" to International Journal of Reconfigurable and Embedded Systems (IJRES), an open access and Scopus indexed (<https://www.scopus.com/sourceid/21101061447>). With the online journal management system that we are using, you will be able to track its progress through the editorial process by logging in to the journal web site:

Manuscript URL:
<https://ijres.iaescore.com/index.php/IJRES/author/submission/21040> <-- It is your paper ID
Username: amar_01

Password: fisikaulm

Before continuing for review process and for avoiding delay on review process, please re-upload your updated paper as "author version" in the same paper ID number within 10 days.

Attention Please!

1. Please try to adhere to the format as closely as possible. Please carefully read our most recent manuscript submission guidelines (<https://iaescore.com/gfa/ijres.docx>).
2. Add the names of all authors (by Edit Metadata), and please provide active or valid emails, as well as author identifiers and academic social network profiles, such as Google Scholar, ORCID, Scopus, and Web of Science ResearcherID (formerly Publons). You can also add your Academia.edu, ResearchGate, LinkedIn, Loop, and other profiles. Please keep in mind that if you do not supply complete, identical, and correct identities between the metadata and the actual document, your article will be rejected!!
3. A high quality paper should have:
 - a) a clear statement of the problem the paper is addressing;
 - b) the proposed solution(s); and
 - c) results achieved. It describes clearly what has been done before on the problem, and what is new. Please clearly state the three points listed above in your updated paper.
4. The number of minimum references for an original research paper is 25 (and at least 20 recently journal articles); and the number of minimum references for a review paper is 50 (and at least 40 recently journal articles).

At this stage, it is critical that you adhere to every detail of the IAES format. Otherwise, we will reject your paper.

When contacting us, please always include your paper ID number in the subject line of your email.

Thank you for considering this journal as a venue for your work.

Best Regards,
Selvakumar Manickam
International Journal of Reconfigurable and Embedded Systems (IJRES)

NOTE: A single author is NOT preferred in this journal, except come from qualified researcher (min WoS/Scopus h-index: 15). We would like to publish high quality papers of a research group. Paper with single author normally will be REJECTED.

URGENT!!

Please respond by answering each question/statement on the following list one by one in order to expedite the publishing of your paper:

1. Is your manuscript up to the required standards? (written in English; at least 4 pages long; no more than 20 pages; use EndNote, Mendeley, or Zotero for reference management and formatting; use IEEE style)

2. Is the format of your manuscript IJRES? It is crucial that you adhere to every aspect of the IJRES format at this point. Please make an effort to adhere to the format (<http://iaescore.com/gfa/ijres.docx>) as precisely as you can.

3. Is your abstract written properly and does your title make sense? Maximum 10 words in the title, no acronyms or abbreviations. The Abstract (MAX 200 WORDS) should be informative and fully self-explanatory (no citation in abstract), and it should clearly describe the issue at hand, suggest a course of action, and highlight key results and conclusions.

4. It is advised that authors provide their papers in the following sections: 1. Introduction - 2. The Proposed Method/Algorithm/Procedure specifically designed (optional) - 3. Research Method - 4. Results and Discussion – 5. Conclusion. After the introductory part, authors may provide intricate theorem proofs or obscure evidence for the soundness of algorithms (obvious theorems & straightforward proofs of existing theorems are NOT needed).

5. Introduction section- Explain the study's context and specify the specific goal in the introduction section. Within three to seven paragraphs, an introduction should provide the following three components:

- Background: The context must be made explicit by authors. Authors should, ideally, provide an overview of the state-of-the-art in the subject area of the report.
- The Problem: If there were no issue, there would be no need to write a text and certainly no need to read it. Please provide readers with a reason to continue reading. Experience has shown us that a few lines are frequently enough for this section.
- The Proposed Solution: Now and only now! The contribution of the text may be described by the authors. Here, authors must make sure that readers identify the new parts of their work.
- By citing pertinent works, authors should set the study in its right perspective. In this section, at least 15 references (current journal publications) are utilized.

6. Method section- The experimental/method section is a straightforward description of what you did in your research and how you did it, clear and detailed at every stage. A detailed method section will make your article reproducible by other researchers, allowing them to trust and build on your

work.

- A detailed explanation of all methodologies, instruments, materials, procedures, measurements, and other variables used in the investigation.
- A thorough description of the data analysis and decisions for excluding some data and including others.

7. Results and discussion section- Results should be presented in an easy-to-understand manner. The most significant findings are presented in this part, together with comparisons to other research findings and, when applicable, the outcomes of statistical analysis. It is not advisable to repeat results from figures in tables. Here, the author(s) should explicitly state what they learned throughout their investigation. It need to be logically organized and clearly set out. Appropriate references should be used to support this section.

8. Conclusion section- Summarize in a paragraph the main findings of the investigation. Are the results supporting the statements in this section, and do they seem reasonable? Have the authors explained how the findings compare to what was anticipated and to past research? Does the article refute or reinforce preexisting theories? Does the analysis of the research's impact on the field of science's body of knowledge?

9. Language. Understanding the science may be made more challenging by articles that are poorly written or contain grammatical errors.

10. Please confirm the document is current. It is anticipated that 10–20% of references will be to current studies.

11. Is the writing in the text clear? The article is intriguing. Does the information flow smoothly from one area to the next? Please strive to maintain the appropriate level for your text. It should be simple enough for highly skilled experts to grasp, but please refrain from discussing well-known information (use proper references instead). Negative evaluations for papers frequently result from the reviewers' inability to grasp the text, which is the authors' (not the reviewers') problem. There is no need to publish the work if reviewers have problems since other readers will have the same issue.

12. Are your references sufficient? Depending on the length of the manuscript, we will typically want a minimum of 15 to 25 references, the majority of which should be to academic articles. Textbook citations should be used extremely sparingly, and web page citations should be avoided. The text of the document should include references to all cited articles.

13. Tables and figures. Relationship between Tables or Figures and Text: All tables and figures should be cited in the content since they support the text. Don't put tables and figures before when they are first mentioned in the text. The reader should be made aware of what to look for while utilizing the table or figure, according to the authors. Leave the reader to independently investigate the specifics and simply highlight the key takeaway that the reader should be able to get from them.

Figures:

- a. All figures appearing in article must be numbered in the order that they appear in the text.
- b. Each figure must have a caption fully explaining the content
- c. Figure captions are presented as a paragraph starting with the figure number i.e. Figure 1, Figure 2, etc.
- d. Figure captions appear below the figure
- e. Each figure must be fully cited if taken from another article
- f. All figures must be referred to in the body of the article

Tables:

- a. Material that is tabular in nature must appear in a numbered captioned table.
- b. All tables appearing in article must be numbered in the order that they appear in the text.
- c. Each table must have a caption fully explaining the content with the table number i.e. Table 1, Table 2, etc.
- d. Each column must have a clear and concise heading
- e. Tables are to be presented with single horizontal line under: the

table caption, the column headings and at the end of the table.

- f. All tables must be referred to in the body of the article
- g. Each table must be fully cited if taken from another article

14. Each citation has to be enclosed in square brackets and listed in the text in the order that it appears. For instance, the first citation [1], the second citation [2], the third and fourth citations [3], [4]. The ideal approach for referencing many sources at once is to state each number separately, in its own brackets, with a comma or dash between numbers, as in [1], [3], [5], or [4]-[8]. The in-text citation does not need to include the author's last name, the pages that they utilized, or the publication date. Instead, cite the source using a number enclosed in square brackets, such as [9], which will then match to the whole citation in your reference list.

Examples of in-text citations:

This theory was first put forward in 1970 [9]."

Sutikno [10] has argued that...

Several recent studies [7], [9], [11]-[15] have suggested that....

...end of the line for my research [16].

15. Self-citations: This journal requests that authors limit their use of self-citation in order to prevent citation manipulation (COPE, 2019). We highly advise limiting the number of self-citations to either 5 (including jointly produced papers) or 20%, whichever is lower.

16. Please be aware that you will be required to modify your paper so that the last page is not partially empty for the final submission of normal paper.

International Journal of Reconfigurable and Embedded Systems (IJRES)
<http://ijres.iaescore.com>

Design of IoT-based Monitoring System for Temperature and Dissolved Oxygen Levels in Catfish Aquaculture Pond Water

Nurma Sari¹, Yuniar Savitri¹, Sri Cahyo Wahyono¹, Joko Santoso¹, Amar Vijai Nasrulloh¹

¹Physics Study Program, University of Lambung Mangkurat, Indonesia

Article Info

Article history:

Received month dd, yyyy

Revised month dd, yyyy

Accepted month dd, yyyy

Keywords:

Catfish aquaculture pond
IoT-based

Dissolved oxygen levels

Temperature

Nodemcu esp8266

ABSTRACT (10 PT)

One of the fish in Indonesian waters that has been successfully bred and cultivated is the catfish (*Pangasius sp.*). In catfish farming, there are several water quality factors that need to be considered, such as temperature and dissolved oxygen levels. This study aims to create an internet of things based (IoT-based) monitoring system for temperature and dissolved oxygen levels in catfish aquaculture pond water based on NodeMCU ESP8266. Monitoring system is using SEN0237 gravity analog dissolved oxygen sensor, DS18B20 sensor module, NodeMCU ESP8266, 20x4 character LCD, Micro SD card module, internet modem. Data from measurements of temperature and dissolved oxygen levels are stored online in the Adafruit.io database in the .csv format and on a micro SD card in the device in the .txt format. The effective value of the probe filling solution on the SEN0237 analog dissolved oxygen sensor is around 3-4 hours. The dissolved oxygen levels and temperature measured during the 3 days measurement have the lowest value of 3,4 mg/L or 3.4 ppm with a temperature of 27,9°C and the highest value of 4,6 mg. /L or 4,6 ppm with a temperature of 30,9°C.

This is an open access article under the [CC BY-SA](https://creativecommons.org/licenses/by-sa/4.0/) license.



Corresponding Author:

Nurma Sari

Physics Study Program, University of Lambung Mangkurat

70714, Banjarbaru, Indonesia

Email: nurmasari01@ulm.ac.id

1. INTRODUCTION

Catfish is one of the native fish in Indonesian waters that grows well. Catfish is a freshwater fish that belongs to the catfish (*Pangasius sp.*) type. Pangasidae can be mass-produced and offers the potential for industrial-scale development due to its basic characteristics of lacking scales, having few spines, having a fairly fast growth rate, and having high fertility and survival rates. With all these benefits, this fish has increased economic value among fishery commodities, both in the hatchery and grow-out business sectors (Nanda Defira et al., 2018). In recent times, real time water quality monitoring in aquaculture has been brought by the fast development of Internet of Things (IoT) technology effectively. Globally, water quality monitoring systems based on IoT and wireless communication technologies have been widely studied intensively [a]-[k].

Dissolved oxygen levels are one of the water quality parameters that can cause large numbers of fish to die. The processes of decomposition, reproduction and development in ponds are hampered by low dissolved oxygen levels. According to Indonesian National Standard (SNI 01-6483.3-2000) for catfish culture, dissolved oxygen levels range from >4 mg/L. The need for fish for dissolved oxygen levels depends on the age of the fish, fish activity, and water quality (Fujaya, 2002). Dissolved oxygen levels in ponds vary from time to time. Siegers Research; Prayitno; and Sari (2019) show that dissolved oxygen levels change due to the influence of changing temperatures due to unstable weather. According to Effendi (2003), dissolved oxygen levels for

fisheries must be at least 5 mg/L. If the concentration of dissolved oxygen is not balanced, the fish will be stressed because the brain does not get enough oxygen. Fish will experience anoxia because their body tissues are unable to bind dissolved oxygen in the blood.

The water temperature of fish farming ponds is an important factor. The ideal temperature tolerance range for catfish according to SNI 01-6483.3-2000 is between 25-30°C. Pool water temperature affects water quality (Lucas and Southgate, 2012). Oxygen solubility is one of the characteristics of water quality that is affected by temperature variations. With increasing temperature, the level of solubility of oxygen decreases (Chin, 2006; Parker, 2012). Once there is an increase in temperature, the amount of solubility of oxygen in water will decrease. An increase in temperature causes the metabolic activity of fish to be greater which results in a doubling of oxygen consumption in fish. (Boyd and F. Lichkoppler, 1979). Low water temperature can affect the ability of fish to bind oxygen so that it can inhibit fish development. (Boyd and F. Lichkoppler, 1979). Fish that experience stress reduce stamina and reduce hunger, and eventually starve to death (Effendi, 2003).

The DS18B20 temperature sensor is a device that can read temperature variations and then translate these changes into electrical quantities. This sensor is connected to the microcontroller using a single cable and is a digital sensor. These sensors are special because each sensor contains a serial code that allows the use of multiple DS18B20s in one 1-cable transmission. (Datasheet DS18B20, 2015). SEN0237 gravity analog dissolved oxygen sensor is a sensor for measuring dissolved oxygen levels in water. These sensors are widely used in various water-related sectors, including research, aquaculture, and monitoring of the aquatic environment. This sensor is open source and compatible with various microcontrollers, allowing users to use it freely and openly (Dfrobot, 2018). NodeMCU ESP8266 is a microcontroller equipped with the ESP8266 chip. This microcontroller has multiple input or output ports to enable monitoring and control applications for IoT projects. The NodeMCU ESP8266 is an evolution of the ESP8266 version of the ESP-12 IoT (Internet of Things) platform module family. This module works very similarly to the Arduino module platform in terms of functionality, but the difference is "Connected to the Internet" (Satria, 2022).

Several studies that have been conducted regarding the measurement of water quality in aquaculture ponds. For instance, Mardhiya, et al (2017) was creating a data acquisition system for measuring dissolved oxygen levels with the results that the average DO level is in the range of 3 to 5 mg/L in rainy conditions and between 3 to 7 mg/L on cloudy conditions. Next, research by Sumardiono, et al (2020), was creating a system for monitoring temperature and dissolved oxygen levels in catfish ponds with the Raspberry Pi that was obtained the water temperature varied with time. Furthermore, research by Suriana, et al (2021) created a temperature remote monitoring system in Bangkok tilapia ponds, the effective temperature for fish pond water was an indicator of 28°C to 30°C.

In this research, a remote and Internet of Things (IoT) based monitoring system for temperature and dissolved oxygen levels in catfish farming ponds will be made using the DS18B20 and SEN0237 Gravity analog dissolved oxygen sensor internet-based sensors which will be tested and implemented in catfish farming ponds. This monitoring system uses NodeMCU ESP8266 as a microcontroller and Adafruit.io as an online interface. By applying IoT technology with an internet network, this up-to-date technology is able to send data and offer speed and a vast distance [Subrata, Arsyad Cahya, et al. "A laboratory scale IoT-based measuring of the solar photovoltaic parameters." *International Journal of Reconfigurable and Embedded Systems* 11.2 (2022): 135.]. This research develops IoT technology for sending parameter data from DO level and temperature directly to a web server. Then, the stored data for 24 hours on the webserver can be processed for further identification all the time.

2. RESEARCH METHOD

The materials used are the sensor module DS18B20, SEN0237 gravity analog dissolved oxygen sensor, SD card module, NodeMCU ESP8266, 20x4 character LCD with I2C, 12V 2A adapter, step down DC to DC converter, tin, electronic components, connecting cables and control panel box.

The NodeMCU ESP8266-based IoT monitoring system for temperature and dissolved oxygen consists of several stages starting with preparing the tools and materials needed in this research. Then proceed with assembling the hardware, namely integrating the NodeMCU ESP8266 with the sensor, and assembling a remote monitoring system for temperature and dissolved oxygen based on the NodeMCU ESP8266. Furthermore, the manufacture of software includes the manufacture of microcontroller software, manufacture of LCD interface software and manufacture of IOT software. Followed by determining the transfer function of measuring instruments, testing the system as a whole and finally data collection.

Calibration is done by comparing the measured value on the sensor with the measured value on a standard measuring instrument. For the DS18B20 sensor, a digital thermometer is used as a comparison. The measurement range used is 10°C to 50°C. Meanwhile, for the SEN0237 gravity analog dissolved oxygen sensor,

a DO meter is used as a comparison. Measurements were made using zero dissolved oxygen powder which was added little by little until a measured DO value of 0 mg/L was obtained.

The software is made using the Arduino IDE software. The IoT interface used is Adafruit.io. to connect NodeMCU ESP8266 with IoT, in the program listing it is necessary to write down the wifi name and password of the wifi used. To link readings to Adafruit.io, the listing should include the Adafruit.io web address, the username of the Adafruit.io account used, the active key, and the name of the feed used.

The monitoring system that is made is tested first by observing each part whether it is working properly. Next, a performance check of the NodeMCU ESP8266 is carried out, can it be connected to the internet so that it reads on Adafruit.io. After connecting to the internet and a notification appears that Adafruit.io has been connected, a comparison is made of the values that appear on the LCD of the device and Adafruit.io. After the reading value of the measuring instrument that appears is appropriate, the tool can be used. Furthermore, pre-data collection is carried out.

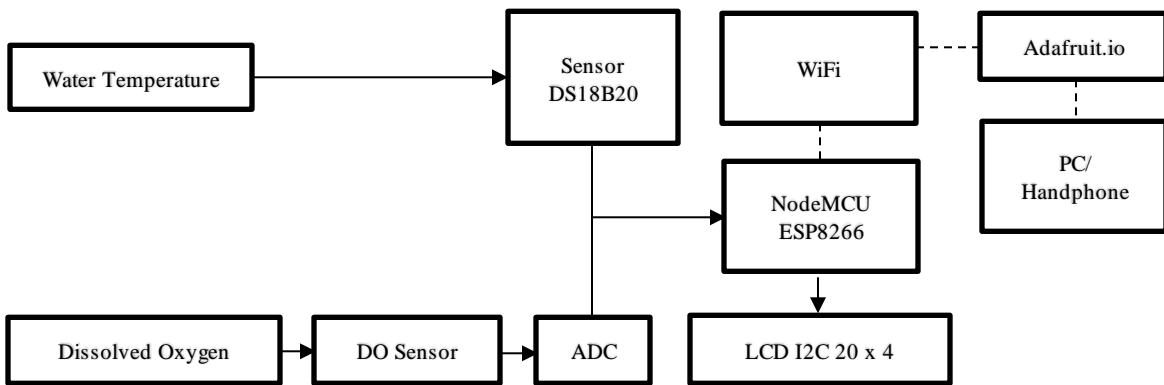

Figure 1. Proposed system block diagram

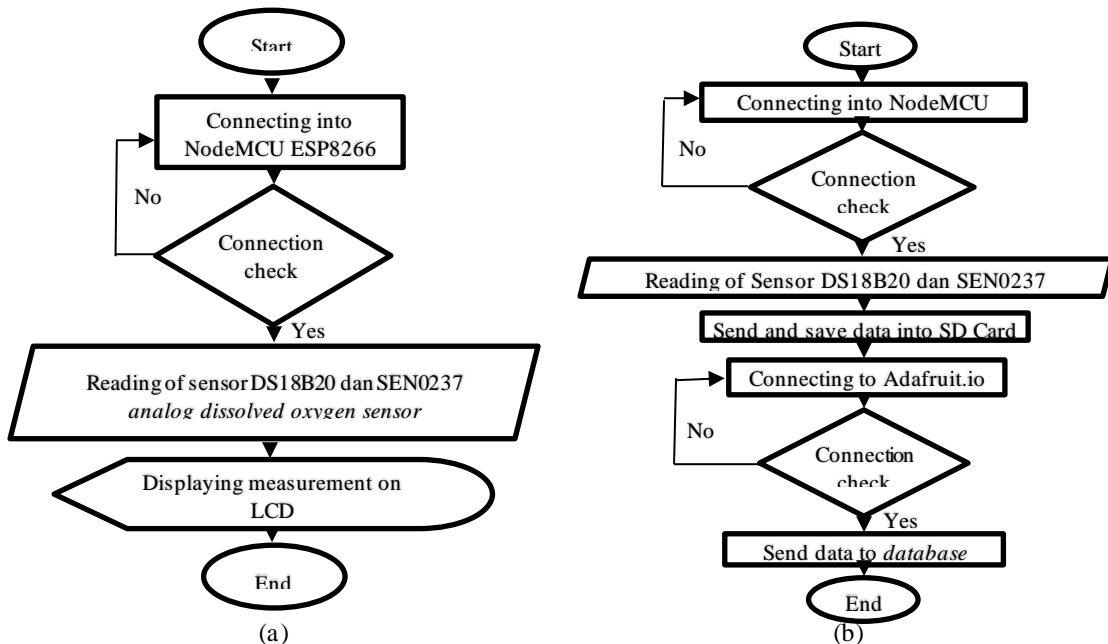

Figure 2. Flowchart of (a) NodeMCU ESP8266 with sensors and LCD, and (b) NodeMCU ESP8266 with IoT

The system developed by the Arduino IDE software and the IoT interface used Adafruit.io. To connect NodeMCU ESP8266 with IoT, in the program listing it is necessary to write down the wifi name and password of the wifi used. To link readings to Adafruit.io, the listing should include the Adafruit.io web address, the username of the Adafruit.io account used, the active key, and the name of the feed used. The monitoring system that is made is tested first by observing each part whether it is working properly. Next, a performance check of the NodeMCU ESP8266 is carried out, can it be connected to the internet so that it reads on Adafruit.io. After

connecting to the internet and a notification appears that Adafruit.io has been connected, a comparison is made of the values that appear on the LCD of the device and Adafruit.io. After the reading value of the measuring instrument that appears is appropriate, the tool can be used. Furthermore, pre-data collection is carried out.

3. RESULTS AND DISCUSSION

The calibration process of the SEN0237 analog dissolved oxygen sensor. Measurements were carried out three times using water mixed with zero dissolved oxygen powder until the dissolved oxygen level in the water was zero mg/L. Based on the results of the sensor readings obtained the regression formula $y = 126.22x - 129.85$ with $R^2 = 0.9664$ and adapted into Arduino program. From the results of retesting conducted, it is known that the average error in sensor readings is 9.3%. Meanwhile, based on the results of the DS18B20 temperature sensor during calibration, it is obtained the regression formula $y = 1.0129x + 0.2557$ with $R^2 = 1$. This equation is then adapted into the Arduino program. It is intended that the readings from the DS18B20 sensor are the same as standard measuring instruments. From the results of retesting, it is known that the average error value of reading is 0.1%.

The readings that appear on the Adafruit IO dashboard are temperature, dissolved oxygen (mg/L), and dissolved oxygen (ppm) in the form of images and gauges. Figure 3 is the interface display on Adafruit IO. The gauge is given a limit value, where if the dissolved oxygen value is below 4 mg/L or 4 ppm and the temperature is below 25 °C and more than 30 °C then the gauge will turn red as a sign that the measurement was carried out in a condition that is not in accordance with SNI 01 - 6483.3-2000. Meanwhile, when the measurement results are >4 mg/L or 4 ppm for dissolved oxygen and the temperature is around 25-30°C, the gauge will turn green. Data display indicators for monitoring can be said to be real-time if the interface for sensor readings that appear on the LCD and the Adafruit.io dashboard is "same". Figure 4 shows the real-time readings of the Adafruit.io LCD and dashboard.



Figure 3. Adafruit.io display developed



Figure 4. Testing and validating of the IoT-based monitoring system

Data stored in the Adafruit.io database can be downloaded in CSV (Comma Separated Value) file format for each feed (Figure 5a). Along side stored online in the Adafruit.io database, measurement data is also stored offline on a micro SD card in the form of a TXT file. The stored data contains time data, SEN0237 analog dissolved oxygen sensor readings in mg/L and ppm units, as well as DS18B20 sensor module readings which are separated by commas “,”. This data can be converted into an spreadsheet table for comparative image analysis. Figure 5b shows the TXT file data written to and stored on the micro SD card.

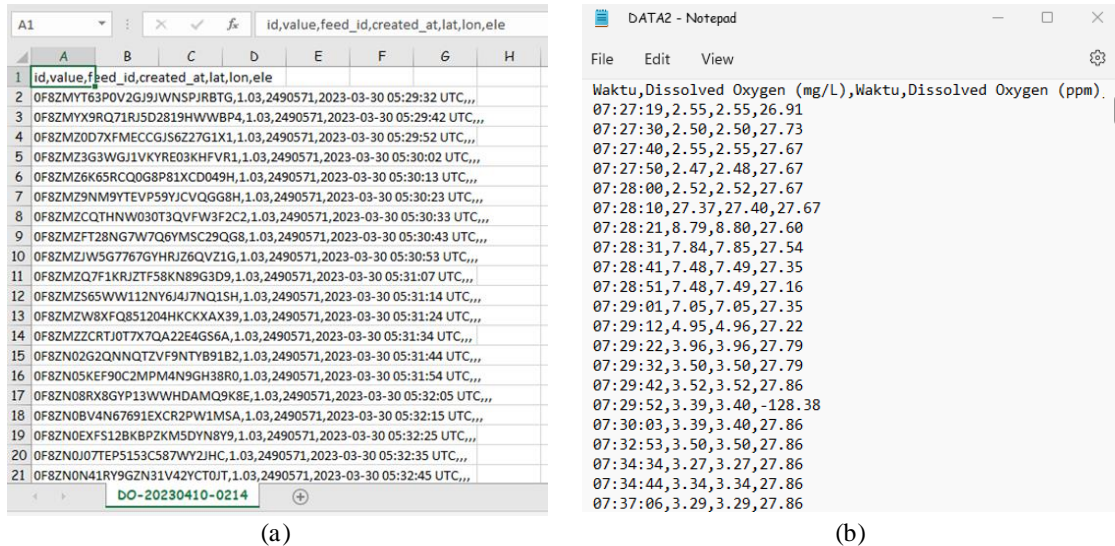

Figure 5. Display of measurement results data of (a) The downloaded from the Adafruit.io database in CSV file format, and (b) The TXT file data written to and stored on the micro SD card

Pre-data collection was carried out for 2 days to determine the readiness of the tool before actual data collection was carried out. Pre-data collection was carried out during weather conditions after rain and in the pond with cloudy weather conditions with rain. Data monitoring can be monitored via cellphones and laptops or other devices that can access the internet. To monitor measurement results via the Internet, users can open a shared link for this monitoring system. The measurement will start when the NodeMCU ESP8266 microcontroller is connected to the internet. The process of connecting the microcontroller to the internet takes ± 40 seconds depending on the speed of internet access. The better the internet network used, the faster the microcontroller is connected. If the internet network is disconnected, the data that is displayed is the last data before the network was disconnected. This monitoring system has a weakness in the DO sensor used, namely the probe filling solution sensor which must always be monitored. At pre-take it is known that the effective use of probe filling solution is around 3-4 hours. Therefore, every 3-4 hours it is necessary to check and replace the probe filling solution so that the measurement results obtained have a good value. The probe filling solution used must always be in good condition and no bubbles form on the filling membrane. The formation of bubbles and poor probe filling solution can affect the measurement results. Figure 6a, 6b, and 6c show the location and the equipment configuration along with its placement in catfish farming ponds.



(a)



(b)

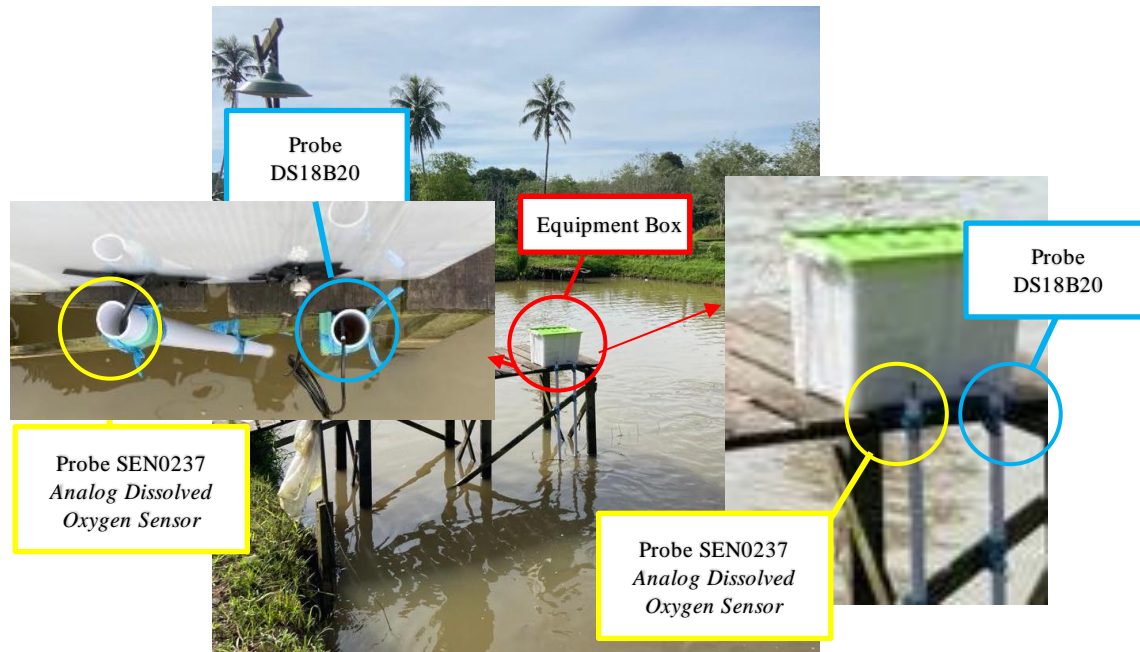

(c)

Figure 6. (a) Location of catfish ponds where data is collected, and (b) Measurement and IoT system processing equipment, and (c) IoT based monitoring system for temperature and dissolved oxygen levels in catfish farming ponds

Data collection was carried out for three days. The measuring instrument is placed on a bridge with a height of ± 80 cm from the water surface with the sensor probe submerged about 2–4 cm from the water surface. During data collection, the weather is constantly changing. Data collection on the first day was in cloudy weather conditions accompanied by rain during the day. The relationship between temperature and dissolved oxygen levels from data collection on the first day can be seen in Figure 7a. Although not very significant, from the figure it is known that when the temperature increases the dissolved oxygen levels decrease and vice versa. From the figure 6a, the relationship between temperature and dissolved oxygen levels is most clearly seen at point a at 13.15, where the DO value reaches 4.5 mg/L or 4.5 ppm with a measured temperature of 28.6 °C. Point a to point b shows a decrease in DO values and temperature due to rain during the day, from 13.15 to 14.30. Apart from when it rains, DO values and measured temperatures also tend to decrease at night as seen at point c at 19.15. The DO value measured after rain and at night fell below 4 mg/L as shown at point c.

Data collection on the second day was cloudy in the morning, then hot during the day and cloudy again in the late afternoon. Figure 7b is a graph of the relationship between temperature and dissolved oxygen levels. Although not very significant, from the figure it is known that when the temperature increases the dissolved oxygen level decreases and vice versa as seen from point f to point g at 19.30 to 20.00. In some conditions there are temperature values that are not in accordance with the theory, such as at points d to e where the temperature values measured exceed the value of 30 °C at 13.00 to 17.30 caused by the hot sun during the day. The DO value at point a to point c, which is between 10.00 and 11.30, is measured to be less than 4 mg/L in the morning with cloudy weather conditions after rain. The low DO value measured at point b is the DO value measured at the time of changing the probe filling solution because when changing the probe is removed from the water. The low DO measured, aside from the effect of temperature, is also caused by other factors such as the water level and the water content.

Data collection on the third day in sunny weather conditions in the morning then hot during the day, cloudy in the late afternoon accompanied by rain at night. Figure 7c is a graph of the relationship between temperature and dissolved oxygen levels. Although not very significant, from the figure it is known that when the temperature increases the dissolved oxygen levels decrease and vice versa. The relationship between temperature and dissolved oxygen can be seen at points d to f at 15.45 to 17.15 where when DO increases the temperature value decreases. In some conditions there are temperature values measured outside the limits of SNI provisions, namely at points c to e at 11.30 to 16.30 the measured values are more than 30 °C. This condition occurs due to the hot weather during the day which causes the temperature to increase. DO values that were measured outside the regulatory limits were seen at points a to b between 10.00 to 10.45 and points f to g at 17.15 to 20.00, where DO values were measured below 4 mg/L. The low DO measured apart from temperature

is also caused by other factors such as water level and water content. From the data image, the most obvious one is at 14.00 where the DO value reaches 4.2 mg/L or 4.2 ppm with a measured temperature of 30.9°C.

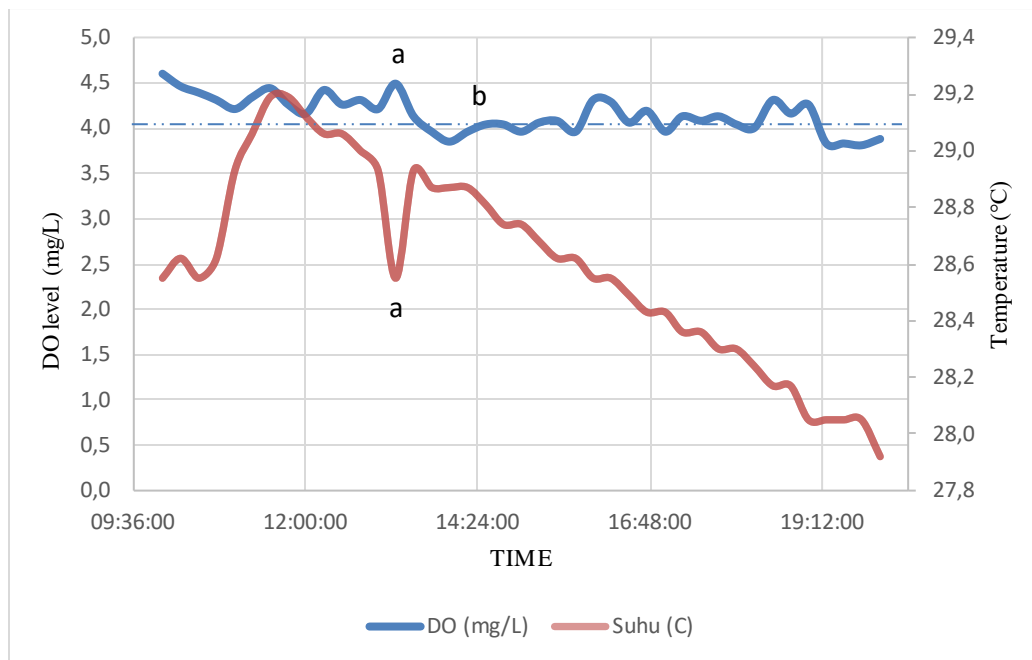

(a)

(b)

(c)

Figure 7. Display of measurement results data of (a) The downloaded from the Adafruit.io database in CSV file format, and (b) The TXT file data written to and stored on the micro SD card

Based on measurements carried out for three days, from 10.00 to 20.00, it is known that the temperature and DO values of the Karang Intan catfish pond are relatively safe and quite good. In the morning DO in fish pond water is quite low, then it increases as the day progresses. When it rains, the measured DO levels also decrease. This is similar to research conducted by Mardhiyana (2017) which obtained an average DO level in the range of 3 to 5 mg/L in rainy conditions and a range of 3 to 7 mg/L in cloudy conditions. Abundant oxygen levels during the day with sunny weather due to the process of respiration by macrophytes in the mechanism of photosynthesis with the help of sunlight. While at night DO decreased again. The decrease in dissolved oxygen levels at night is due to the absence of photosynthesis at night, also caused by the level of temperature fluctuations by the air, the increased respiration rate of sediment by bacteria and the more intense respiration rate in fish ponds by aquatic organisms. As for the temperature, it is influenced by the surrounding conditions. As the day gets darker, when the weather is cloudy and it rains, the measured temperature decreases and vice versa, when the weather is sunny and the sun is hot enough, the measured temperature increases. This is similar to research conducted by Sumardiono (2020), for example when it is sunny the temperature will rise to around 29°C, when it is foggy it will drop to around 27.7°C, and at night it will generally drop to around 29.4°C. The graph of the maximum and minimum values of DO and temperature measured for 3 days can be seen in Figure 8.

From Figure 8 it can be seen that DO tends to be lower in the morning, then increases as the day progresses. Where it can be seen that for 3 days the measurement was carried out, the maximum value of DO that was measured was obtained at 10.00, 14.30 and 11.45. At night DO tends to decrease, where from the data obtained it is recorded that the minimum DO value is at 19.45, 10.00 and 10.30. Meanwhile, the temperature tends to increase during the day and decreases in the afternoon until the evening. From the data recorded from measurements for three days, it was found that the temperature experienced a maximum value at 11.45, 15.00 and 13.30. The minimum temperature recorded is at 20.00 and 10.00. The low temperature measured in the morning is caused by temperature changes that occur at night accompanied by rain, so that when measurements are taken in the morning the measured temperature tends to be low. From the measurement data obtained, it is known that dissolved oxygen levels are indeed affected by temperature, but this factor does not have a

significant effect. There are other factors that affect dissolved oxygen levels in fish pond water. Even so, the water quality measured in the catfish pond is fairly good because the DO and measured temperatures are still within safe limits. The circulation of fish pond water is quite good so that even though the measured DO was below the SNI 01-6483.3-2000 standard for catfish cultivation, DO can again increase to the threshold according to SNI 01-6483.3-2000.

4. CONCLUSION

An IoT-based monitoring system for temperature and dissolved oxygen levels in catfish farming ponds using the DS18B20 and an internet-based DO sensor has been successfully developed. This monitoring system are able to measure temperature and dissolved oxygen levels which have a reading error value for the DS18B20 sensor of 0.1% and for the SEN0237 analog dissolved oxygen sensor 9.3%. The effective value of the probe filling solution on the SEN0237 analog dissolved oxygen sensor is around 3-4 hours. A water quality monitoring system has been implemented in Mr. Abdul Basit's catfish pond in Karang Intan for 3 days starting from 10.00 to 20.00. From the measurements that have been made, it is obtained that the dissolved oxygen level and temperature measured during the measurement have the lowest value of 3.4 mg/L or 3.4 ppm with a temperature of 27.9 °C and the highest value of 4.6 mg/L or 4, 6 ppm with a temperature of 30.9°C.

ACKNOWLEDGEMENTS

Author thanks In most cases, sponsor and financial support acknowledgments.

REFERENCES

- Boyd, C. E., and F. Lichkoppler. *Water Quality Management in Pond Fishculture*. Station Research and Development series, 1979. Datasheet. *Programmable Resolution 1-Wire Digital Thermometer*. 2015, <https://www.analog.com/media/en/technical-documentation/data-sheets/DS18B20.pdf>.
- Dfrobot. *SEN0237 Grafty Analog Dissolved Oxygen Sensor*. 2018, https://wiki.dfrobot.com/Gravity__Analog_Dissolved_Oxygen_Sensor_SKU_SEN0237.
- Effendi, H. *Telaah Kualitas Air*. kanisius, 2003.
- Fujaya, Y. *Fisiologi Ikan: Dasar Pengembangan Teknologi Perikanan*. Direktorat Jen. Pend. Tinggi. 2002.
- Mardhiya, I. R. "Sistem Akuisisi Data Pengukuran Kadar Oksigen Terlarut Pada Tambak Udang Menggunakan Sensor Dissolved Oxygen(DO)." *Skripsi*. Jurusan Fisika. Fakultas Matematika dan Ilmu Pengetahuan Alam. Universitas Lampung, 2017.
- Nanda Defira, Cut, et al. "The Effect of Different Life Feed on Growth and Survival of Eatfish Fry (*Pangasius Sp.*)" *Jurnal Ilmiah Mahasiswa Kelautan Dan Perikanan Unsyiah*, vol. 3, no. 1, 2018, pp. 14–22.
- Satria, Beni. "IoT Monitoring Suhu Dan Kelembaban Udara Dengan Node MCU ESP8266." *Sudo Jurnal Teknik Informatika*, vol. 1, no. 3, 2022, pp. 136–44, doi:10.56211/sudo.v1i3.95.
- Standar Nasional Indonesia. "Produk Induk Ikan Patin Siam (*Pangasius hyphtalamus*) Kelas Induk Pokok (*Parent Stock*)." SNI: 01-6283.3-2000.
- Sumardiono, A., Rahmat, S., Alimudin, E. and Illahi, N. A. "Sistem Kontrol-Monitoring Suhu dan Kadar Oksigen Pada Kolam Budidaya Ikan Lele", *JTERA (Jurnal Teknologi Rekayasa)*, vol. 5, no. 2, 2020, pp.231-236.
- Suriana, Lubis, A. P., and Rahayu, E. "Sistem Monitoring Jarak Jauh Pada Suhu Kolam Ikan Nila Bangkok Memanfaatkan *Internet of Things (IoT)* Berbasis *NodeMCU ESP8266*." *JUTSI (Jurnal Teknologi dan Sistem Informasi)*, vol. 1, no. 1, 2021, pp. 1-8.
- [a] Charlotte D., Philippe C. and Samuel D., "IoT for Aquaculture 4.0: Smart and easy-to-deploy real-time water monitoring with IoT", in Proc. Conference: 2018 Global Internet of Things Summit (GIoTS), Bilbao, Spain, 4-7 June 2018.
- [b] Cesar Encinas et al., "Design and implementation of a distributed IoT system for the monitoring of water quality in aquaculture," In Proc. the 2017 Wireless Telecommunications Symposium (WTS), Chicago, USA, 26-28 April 2017.
- [c] L. J. Xu et al., "Design of aquaculture system based on wireless monitoring and its testing," *International Journal of Online and Biomedical Engineering*, vol. 10, no. 5, pp. 68-73, 2014.
- [d] M. Li et al., "A wireless ecological aquaculture water quality monitoring system based on LoRa technology," in Proc. the 2019 International Conference on Wireless Communication, Network and Multimedia Engineering (WCNME 2019), Guilin, China, pp. 5-7, April 21-22, 2019.
- [e] Z. Mingfei et al., "Design and development of water quality monitoring system based on wireless sensor network in aquaculture," *Computer and Computing Technologies in Agriculture IV. CCTA 2010. IFIP Advances in Information and Communication Technology*, vol. 347, Springer, Berlin, Heidelberg, 2010.
- [f] L. Hongpin et al., "Real-time remotemonitoring system for aquaculture water quality," *Int. Journal Agric & Biol Eng.*, vol. 8, no. 6, pp. 136 – 143, 2015.
- [g] F. A. Saparudin et al., "Wireless water quality monitoring system for high density aquaculture application," *Indonesian Journal of Electrical Engineering and Computer Science*, vol. 13, no. 2, pp. 507~513, February 2019.
- [h] D. S. Simbeye and S. F. Yang, "Water quality monitoring and control for aquaculture based on wireless sensor networks," *Joumal of Networks*, Vol. 9, No. 4, pp. 840-849, April 2014.
- [i] S. Saha, R. Hasan Rajib and S. Kabir, "IoT - Based Automated Fish Farm Aquaculture Monitoring System," 2018 International Conference on Innovations in Science, Engineering and Technology (ICISSET), Bangladesh, 2018, pp. 201 -206.
- [j] C. Encinas, E. Ruiz, J. Cortez and A. Espinoza, "Design and implementation of a distributed IoT system for the monitoring of water quality in aquaculture," 2017 Wireless Telecommunications Symposium (WTS), Chicago, IL, 2017, pp. 1-7.

[k] Parra, L.; Sendra, S.; García, L.; Lloret, J., "Design and deployment of low-cost sensors for monitoring the water quality and fish behavior in aquaculture tanks during the feeding process," *Sensors*, 2018, 18, 750.

BIOGRAPHIES OF AUTHORS

	<p>Nurma Sari received the Bachelor's degree in Physics (1996) from University of Diponegoro (UNDIP) and a masters degree in Physics (2007) specializing in waveguide antenna from Institut Teknologi Sepuluh Nopember (ITS). She received Doctoral degree in Physics (2022) at Institut Teknologi Sepuluh Nopember (ITS), Indonesia, funded by BUDI-DN LPDP Indonesia. Her interdisciplinary research interests focus on applying Physics, applying electromagnetics, applying optics and waveguide antenna. He can be contacted at email: scwahyono@ulm.ac.id.</p>
	<p>Sri Cahyo Wahyono received the Bachelor's degree in Physics (1997) from University of Diponegoro (UNDIP) and a masters degree in Physics (2004) specializing in waveguide antenna from Institut Teknologi Sepuluh Nopember (ITS), Indonesia, funded by DIKTI Indonesia. His interdisciplinary research interests focus on applying physics and geophysics. He can be contacted at email: scwahyono@ulm.ac.id.</p>
	<p>Joko Santoso received the bachelor's degree in physics (2019) from University of Lambung Mangkurat (ULM). He is currently a technician in instrumentation and computational physics laboratories at University of Lambung Mangkurat, Indonesia. He can be contacted at email: jokosantoso1507@gmail.com.</p>
	<p>Amar Vijai Nasrulloh received an undergraduate degree in Physics (2004) from Institut Teknologi Sepuluh Nopember (ITS) and a masters degree in Electrical Engineering (2010) specializing in Biomedical Engineering from Institut Teknologi Bandung (ITB) and a PhD degree in Bioimage Informatics from Durham University, UK, funded by LPDP Indonesia. He is currently a lecturer in Physics Study Program at University of Lambung Mangkurat, Indonesia. His interdisciplinary research interests focus on applying physics and image processing methods to biology and medicine. He can be contacted at email: amarvijai01@ulm.ac.id.</p>



Fwd: [IJRES] Scopus indexed SJR Q3 | Editor Decision: minor revisions

1 message

Amar Vijai Nasrulloh <amarvijai01@ulm.ac.id>
To: Nurma Sari <nurmasari01@ulm.ac.id>

Mon, Sep 4, 2023 at 4:34 AM

----- Forwarded message -----

From: **Selvakumar Manickam** <ijres@iaesjournal.com>

Date: Sat, Sep 2, 2023 at 12:06 AM

Subject: [IJRES] Scopus indexed SJR Q3 | Editor Decision: minor revisions

To: Amar Vijai Nasrulloh <amarvijai01@ulm.ac.id>

-- Paper ID# 21040

-- Please read the guidelines (<http://iaescore.com/gfa/ijres.docx>) carefully and strictly follow them when submission your revised paper! Papers that do not adhere to the guidelines will be rejected from the journal.

-- Number of min references is 25 entries and the similarity score of your final manuscript must be less than 25%

-- Please upload the revised paper within 8 weeks

Dear Prof/Dr/Mr/Mrs: Amar Vijai Nasrulloh,

We've made a decision on your submission "Design of IoT-based Monitoring System for Temperature and Dissolved Oxygen Levels in Catfish Aquaculture Pond Water" to International Journal of Reconfigurable and Embedded Systems (IJRES), p-ISSN 2089-4864, e-ISSN 2722-2608, a Scopus indexed peer-reviewed journal (<https://www.scopus.com/sourceid/21101061447>). This journal has been included in the SCImago Journal Rank (SJR, <https://www.scimagojr.com/journalsearch.php?q=21100901206&tip=sid&clean=0>) and has an SJR of 0.218 (Q3).

Our decision is that minor revisions are required.

The manuscript must be related to and contribute to the field of reconfigurable systems, embedded systems, VLSI design, or the internet of things (IoT). Method section is a crucial part of an article. Therefore, it should be presented sufficient clear and complete in every detail facilitating reproducible by other scientists. For your information, according to international regulations, similarity score of camera-ready paper must be less than 25%. Single author in this journal is PROHIBITED. You are asked to submit a revised full manuscript, according to the comment from reviewers. The Editors will check whether the revision already address the reviewers' comments. Failing to do proper revision may lead to the rejection of your paper. The goal of your revised paper is to describe novel technical results.

Please submit your revised paper within 8 weeks, and strictly adhere to the template's instructions while using the Word (<https://iaescore.com/gfa/ijres.docx>) or LateX (<https://iaescore.com/gfa/ijres.rar>) formats for manuscripts.

I look forward for hearing from you

Thank you

Best Regards,
Assoc. Prof. Dr. Selvakumar Manickam
Editor-in-Chief, IJRES
ijres@iaesjournal.com

URGENT!! YOU HAVE TO DO IT!! Please make sure to double-check your final camera-ready document!!

1). Please follow the authors' guidelines as closely as possible! The IJRES author's guide and template can be found at <http://iaescore.com/gfa/ijres.docx> (or <https://iaescore.com/gfa/ijpeds.rar> for the LaTeX version).

<http://ijres.iaescore.com/index.php/IJRES/about/editorialPolicies# custom-1>

2). The final paper must be presented in the "IMRAD" section style.

1. INTRODUCTION

2. The Proposed Method/Algorithm/Procedure specifically designed (optional)

3. METHOD

4. RESULTS AND DISCUSSION

5. CONCLUSION

See <http://iaescore.com/gfa/ijres.docx>

3). Add biographies of the authors (with links to their profiles; don't get rid of any of the icons in the template). It must be done! See

<http://iaescore.com/gfa/ijres.docx>

4). Please make sure that all of your sources are listed in the text. Use EndNote, Mendeley, or Zotero to organize and format your references, and choose IEEE style. Each citation should be written in square brackets in the order that it appears in the text. For instance, the first citation [1], the second citation [2], and the third and fourth citations [3], [4]. When citing more than one source at once, it's best to put each number in its own brackets and put a comma or dash between each number, like this: [1, 3, 5]. In-text citations don't have to include the name of the author, the pages used, or the date of publication. Instead, use a number in square brackets, like [9], to refer to the source. This number will match the full citation in your reference list. Examples of citations in the text:

This theory was first put forward in 1970 [9].

Zadeh [10] has argued that ...

Several recent studies [7], [9], [11]-[15] have suggested that...

... end of the line for my research [16].

Please give as much information as possible about each reference and do it in IEEE style (including DOIs, volume, number, pages, and so on). DOI information must be given if it is available!! See

<http://iaescore.com/gfa/ijres.docx>.

If you need more materials to add to your references to make your paper better, please look at our journal below.

- <http://ijra.iaescore.com>

- <http://ijaas.iaescore.com>

- <http://ijict.iaescore.com>

- <http://beei.org>

- <http://ijpeds.iaescore.com>

- <http://ijece.iaescore.com>

- <http://ijeecs.iaescore.com>

- <http://ijai.iaescore.com>

- <http://journal.uad.ac.id/index.php/telkomnika>

5). Make all the tables according to the template we gave you (NOT as a figure).

6). Use different patterns in your figures and graphs to show different results (instead of different colors). It must be done! See

<http://iaescore.com/gfa/ijres.docx>

The following template is an example of how you should respond to reviewers' comments.

I would like to thank the reviewers for their insightful feedback. All comments from Reviewer 1 are highlighted in yellow, those from Reviewer 2 are highlighted in red, and those from Reviewer 3 are highlighted in green.

Reviewer 1

Comment 1: There are some references that are not required.

Response: We thoroughly updated our references; 5 references were eliminated, and two were replaced by more recent publications.

Comment 2: The presentation of Figures 2 and 3 should be improved.

Response: The necessary adjustments have been made.

Comment 3: Equation (2) seems to be incorrect.

Response: Equation (2) is correct. This can be proven as follows:...

In order to clarify equation 9 in the manuscript, the following remarks have been added... etc.

All changes for reviewer 1 are highlighted in yellow in the main text.

Reviewer 2

Comment 1:

Response:

Comment 2:

Response:

Comment 3:

Response:

All changes for reviewer 2 are highlighted in red in the main text.

Etc.

Such a document clarifies everything and will aid the reviewers in evaluating the work fast.

When providing your amended primary document files, you must also upload your corrections statement. Before your manuscript, the declaration of revisions should appear.

Reviewer C:

Does the title of the paper accurately reflect the major focus contribution of this paper?:

Yes

Is the abstract a clear description of the paper?:

Yes

Is the paper well written (clear, concise, and well organized)?:

Yes

Is the paper technically sound?:

Yes

The grade of the contribution of the paper to the field?:

Good

Confidential Comments to the Editors::

Comments to the Authors:

Reviewer's comments and suggestions to improve the paper. (If it is not possible, kindly please use separate sheets or a copy of the paper for

comments and suggestions for revision. Indicate whether revisions are mandatory or suggested. Please use word processing type format if possible, and then upload from the online system or submit via email to ijres@iaescore.com and cc to ijres@iaesjournal.com)

:

This research paper discusses a very good and interesting topic of research. There are many new results in this research paper, and all results are supported by figures and tables. This paper presents a good discussion of all results. However, I have seen some weaknesses must be corrected:

1. Before it appears, Figure 1, 2, 5, 6 and 7 must be mentioned and explained in the body text; kindly cite it. Put at least three sentences into the explanation of the Figure.
2. Please mention the main Figure 5, 6 and 7 first before the sub-figure of Figure (a) and (b).
3. Keep your paragraphs complete. A minimum of three sentences should make up each paragraph, one of which should be the lead or key statement and at least the other two acting as supporting sentences.
4. Conclusion section need to be improved, since it is very brief, as well as need to explain what the limitations of this method and future work are. There should be no citation and discussion in the Conclusion, please remove it or move it into the previous section(s).
5. Future research should be described in the conclusion.
6. The format of some of the references is not in standard form. These need to be checked and fixed. It would be better to follow the IEEE citation style consistently. Use EndNote, Mendeley, or Zotero to make it easier for you reference management and formatting in your manuscript.
7. Complete the author biographies section by including as many links as you can to each researcher's social media accounts, including Scopus, ORCID (mandatory), Google Scholar, and Clarivate (if any).

 Reviewer E:

Does the title of the paper accurately reflect the major focus contribution of this paper?:

Yes

Is the abstract a clear description of the paper?:

No

Is the paper well written (clear, concise, and well organized)?:

No

Is the paper technically sound?:

Yes

The grade of the contribution of the paper to the field?:

Average

Confidential Comments to the Editors::

1. Does the title of the paper accurately reflect the major focus of this paper?

Yes, the paper accurately reflects the major focus of this paper

2. If no, please suggest a change to the title as appropriate. Is the abstract an appropriate and adequate digest of the work?

Nil

3. Is the paper clear, concise, and well organized?

This paper can be improved.

4. Rate of the contribution strength to the field is represented in this paper? (Very Good, Good, Average, Below average, or Poor)

Average

5. Rate the scientific quality of the paper? (Very Good, Good, Average, Below Average, or Poor)

Average

6. As far as your knowledge, have the authors already published a very similar paper?

Uncertain

7. If yes, kindly please cite below Do authors place the paper in proper context by citing relevant papers?

Nil

8. Is the paper free from obvious errors, misconceptions, or ambiguity?

Yes

9. Is the paper written in correct English?

Need to Proofread

10. If No, please note grammatical errors and suggest corrections Are the references in IAES style?

Nil

11. Are the figures and tables in IAES style, clear, relevant, and are the captions adequate?

Yes

12. Is the length of the paper adequate?

Yes

13. Please mark appropriate scale for the overall grade for this paper? 10, 9, 8, 7, 6, 5, 4, 3, 2, 1 or 0 (A score of 7 or above typically provides ground for IJRES acceptance)

6

14. Reviewer's comments and suggestions to improve the paper. (If it is not possible, kindly please use separate sheets or a copy of the paper for comments and suggestions for revision. Indicate whether revisions are mandatory or suggested.

Please use word processing type format if possible, and then upload or submit via email to ijres [at] iaesjournal.com

Comments to the Authors:

Reviewer's comments and suggestions to improve the paper. (If it is not possible, kindly please use separate sheets or a copy of the paper for comments and suggestions for revision. Indicate whether revisions are mandatory or suggested. Please use word processing type format if possible, and then upload from the online system or submit via email to ijres@iaescore.com and cc to ijres@iaesjournal.com)

:

Abstract:

- The author has to include the Problem statement in the Abstract

Introduction

- Please improve your writing style of citing other's research (ex: [24],[25],[26])

- Please follow straightly the journal formatting

Methodology

- Please use Subtopic to separate the Material and Method section.
- Please state the number of Figures in the text. (Figure1 & Figure 2)
- Add the circuit design in this section.
- Suggestion: Separate hardware section and software section
- Add equation, technique used in this paper

Result

- Please put the results data in the table.
- Figure 6 (a,b,c) removed from the Result section to the Methodology section
- The result is not clearly presented.

References

- Use the latest references (in 5 years) and followed the journal

References format

revisions are mandatory

Reviewer G:

Does the title of the paper accurately reflect the major focus contribution of this paper?:

Yes

Is the abstract a clear description of the paper?:

Yes

Is the paper well written (clear, concise, and well organized)?:

Yes

Is the paper technically sound?:

Yes

The grade of the contribution of the paper to the field?:

Good

Confidential Comments to the Editors::

Comments to the Authors:

Reviewer's comments and suggestions to improve the paper. (If it is not possible, kindly please use separate sheets or a copy of the paper for comments and suggestions for revision. Indicate whether revisions are mandatory or suggested. Please use word processing type format if possible, and then upload from the online system or submit via email to ijres@iaescore.com and cc to ijres@iaesjournal.com)

:

1. Abstract: Consider including specific numerical values for the lowest and highest dissolved oxygen and temperature readings obtained during the three-day measurement to provide more concrete results.

2. Introduction: Add a brief explanation of how IoT technology can address the challenges of real-time water quality monitoring in aquaculture and its advantages over traditional methods.

3. Methodology: Provide more details about the specific steps and procedures involved in the calibration of the DS18B20 and SEN0237 sensors. Clarify the criteria used to determine the effective value of the probe filling solution for the dissolved oxygen sensor.

4. Results and Discussion: Present the data obtained in a more organized and clear manner using tables and charts. Elaborate on the implications of the observed relationship between temperature and dissolved oxygen levels for catfish health and growth.

5. Technical Information: Include the technical specifications of the sensors used (e.g., measurement range, accuracy, resolution) to provide a better understanding of their capabilities and limitations.

Overall, the paper provides valuable insights into the design and implementation of an IoT-based monitoring system for catfish aquaculture ponds. However, adding more technical details and organizing the results in a more accessible format will enhance the clarity and comprehensibility of the research.

Reviewer I:

Does the title of the paper accurately reflect the major focus contribution of this paper?:

Yes

Is the abstract a clear description of the paper?:

Yes

Is the paper well written (clear, concise, and well organized)?:

No

Is the paper technically sound?:

Yes

The grade of the contribution of the paper to the field?:

Good

Confidential Comments to the Editors::

Try to avoid repetition of the same content.

Try to include common language in the paper. It is found that some reference papers are not in English. Suggested to include papers in English for the better understanding

Comments to the Authors:

Reviewer's comments and suggestions to improve the paper. (If it is not possible, kindly please use separate sheets or a copy of the paper for comments and suggestions for revision. Indicate whether revisions are mandatory or suggested. Please use word processing type format if possible, and then upload from the online system or submit via email to ijres@iaescore.com and cc to ijres@iaesjournal.com)

:

1. Is there any specific reason to use the selected sensor models? Are the sensors calibrated.? Is the calibration report available?
2. On the second page, 2nd paragraph fourth line – It is mentioned one-1-cable transmission. Is it one-to-one cable transmission or one-cable transmission?
3. Mentioned in the paper about Tilapia ponds in Bangkok. Is there any similarity between our species?
4. Why are you using Adafruit.io? Is any specific reason or comparison available?
5. Instead of DC-DC step-down transformer, Does the variable DC power supply supports our overall device?
6. On the 3rd page, the first and second paragraphs is having some content. Avoid repetition.
7. Is the accuracy of 0.1% still obtained? Is the durability being same for digital and Analog sensors? Also, the response time of two types of sensors is required.
8. Can the report have downloaded automatically in the required intervals and automatically received through electronic devices and also widget display on mobile phones?
9. It is said that for every 3-4 hours the probe filling solution needs to be changed, what's the cost for this alone for a day? Also, the total cost of implementation and the cost of maintenance.
10. Instead of top-level DO take into consideration and measurement, can we take the full-depth DO measurement in one or two points in a pond?

International Journal of Reconfigurable and Embedded Systems (IJRES)
<http://ijres.iaescore.com>

**Fwd: [IJRES] Scopus indexed SJR Q3 | Editor Decision: minor revisions**

2 messages

Amar Vijai <amarvijai01@ulm.ac.id>
To: Nurma Sari <nurmasari01@ulm.ac.id>

Sun, Dec 10, 2023 at 12:09 AM

Alhamdulillah sdh accepted.
Tinggal bayar n cek turnitin.
Batas waktu 6 minggu, jd msh bs sante.

Amar

Begin forwarded message:

From: IJRES Editor <ijres@iaesjournal.com>
Date: 10 December 2023 00.25.36 GMT+8
To: Amar Vijai Nasrulloh <amarvijai01@ulm.ac.id>
Subject: Re: [IJRES] Scopus indexed SJR Q3 | Editor Decision: minor revisions

--Paper ID # 21040
--We usually want at least 25 references, most of which should be to journal papers (for research papers).
--IJRES Author Guidelines and Template: <http://www.iaescore.com/gfa/ijres.docx>
--Please send us your similarity report. You can use software like iThenticate or Turnitin to make sure that the result is below 20%. If the similarity index is more than 20%, the paper will not be published when planned or at all.
--Your final paper needs to be turned in within 6 weeks!

Dear Prof/Dr/Mr/Mrs: Amar Vijai Nasrulloh,

Your article titled "Design of IoT-based Monitoring System for Temperature and Dissolved Oxygen Levels in Catfish Aquaculture Pond Water" has been accepted for publication in the International Journal of Reconfigurable and Embedded Systems (IJRES), p-ISSN 2089-4864, e-ISSN 2722-2608, a peer-reviewed and open access journal distributed under the terms and conditions of the Creative Commons Attribution-ShareAlike 4.0 International License, and indexed by Scopus (<https://www.scopus.com/sourceid/21101061447>). This journal has been included in the SCImago Journal Rank (SJR, <https://www.scimagojr.com/journalsearch.php?q=21100901206&tip=sid&clean=0>) and has an SJR of 0.218 (Q3). Congratulations!

Please submit your final work along with your similarity report and proof of payment to IJRES@IAESJOURNAL.COM within six weeks. Highlight your contribution to the field of reconfigurable systems, embedded systems, VLSI design, or the internet of things (IoT). In your final work, you must strictly adhere to the authors' guide (<http://iaescore.com/gfa/ijres.docx>) and the checklist (<https://s.id/c1sSy> or <http://iaescore.com/gfa/ijres.docx>).

Make sure to complete the biographies of authors as our template (include links to the 4 authors' profiles, do not delete any icons in the template). Provide links for all authors to the 4 icons (Scholar, Scopus, Publons and ORCID). It is mandatory!!

Instead of using different colors to convey different results in your graphics, use different patterns. Using software such as iThenticate or Turnitin, the similarity rate should be determined (that the result is less than 20 percent). If the similarity index is greater than 20%, your manuscript will be delayed for publication until it falls below 20%.

When you send in all of the above documents and your final paper follows all of the final instructions, your paper will be judged "fully accepted." It will be the date of your paper's acceptance.

Your cooperation is very appreciated.

Thank you

Best Regards,
Assoc. Prof. Dr. Selvakumar Manickam
Editor-in-Chief, IJRES
ijres@iaesjournal.com

A high-quality research report MUST have the following elements:
(1) a clear definition of the problem addressed by the study --> explain in the "Introduction" section
(2) the suggested solution(s), method(s), approach(es), framework(s), algorithm(s), etc.
(3) Achieved outcomes It thoroughly discusses previous work on the subject as well as what is new.

This journal is free and accessible to the public. Why publish open access? IAES open access writers gain from the following: a quality, established, and respected publication, reaching crucial audiences with 5 million readers each month, high citations, and so on. So, the open access fee is paid by the authors, or on their behalf, to support the cost of wide open access dissemination of research results; to pay a deposit to CrossRef in order for each published article to have a Digital Object Identifier (DOI); to manage the various costs associated with handling and editing submitted manuscripts; and journal management and publication in general.

Each accepted paper (written by two or more authors) is charged USD 295 to help pay for some of the publication costs. This fee covers the first 8 pages. Any published manuscript with more than 8 pages will cost an extra USD 50 per page. You can't have just one author. If the author is the only author, the publication fee is USD 450 for the first 8 pages, which is twice the normal fee. Any published manuscript that is longer than 8 pages will cost an extra USD 100 per page. For Indonesian authors, please refer to xe.com for the USD to IDR currency conversion.

The payment should be made by bank transfer (T/T):

Bank Account name/Beneficiary (please be exact): TOLE SUTIKNO
Bank Name: Bank Syariah Indonesia (PT Bank Syariah Indonesia Tbk)*
Branch Office: Yogyakarta Kusumanegara
City: Yogyakarta
Country: Indonesia
Bank Account #: 7168633321
SWIFT Code (BIC) / IBAN: BSMDIDJAXXX
*Predecessors: Bank Syariah Mandiri (PT Bank Syariah Mandiri Tbk)
see: https://en.wikipedia.org/wiki/Bank_Syariah_Indonesia

or as alternative, you can pay by using PayPal to email: INFO@IAESJOURNAL.com

Bank's detailed address:

Bank Syariah Indonesia (BSI)
[Jl. Kusumanegara No.112, Muja Muju, Kec. Umbulharjo](#)
City: Yogyakarta
Province: D.I. Yogyakarta
Country : Indonesia
Post Code: 55165
Indonesia, Phone:+62 274 417222

The Beneficiary's address:

D2, [Griya Ngoto Asri, RT 06, Bangunharjo, Sewon](#)
City: Bantul
Province: D.I. Yogyakarta (DIY)
Post Code: 55187
Country: Indonesia

On Thu, Oct 26, 2023 at 10:15 AM Amar Vijai Nasrulloh <amarvijai01@ulm.ac.id> wrote:
Dear Assoc. Prof. Dr. Selvakumar Manickam,
Editor-in-Chief, IJRES

I would like to thank the reviewers for their insightful feedback. hereby attached two files that are revised manuscript and the detailed response to the reviewers. All comments from Reviewer C are highlighted in yellow, those from Reviewer E are highlighted in red, those from Reviewer G are highlighted in green, and those from Reviewer I are highlighted in blue.

Yours Sincerely,
Amar Vijai Nasrulloh

On Sat, Sep 2, 2023 at 12:06 AM Selvakumar Manickam <ijres@iaesjournal.com> wrote:

-- Paper ID# 21040

Nurma Sari <nurmasari01@ulm.ac.id>
To: Amar Vijai <amarvijai01@ulm.ac.id>

Sun, Dec 10, 2023 at 1:41 AM

Alhamdulillah...
[Quoted text hidden]

Design of IoT-based Monitoring System for Temperature and Dissolved Oxygen Levels in Catfish Aquaculture Pond Water

Nurma Sari¹, Yuniar Savitri¹, Sri Cahyo Wahyono¹, Joko Santoso¹, Amar Vijai Nasrulloh¹

¹Physics Study Program, University of Lambung Mangkurat, Indonesia

Article Info

Article history:

Received month dd, yyyy

Revised month dd, yyyy

Accepted month dd, yyyy

Keywords:

Catfish aquaculture pond

IoT-based

Dissolved oxygen levels

Temperature

Nodemcu esp8266

ABSTRACT (10 PT)

One of the fish in Indonesian waters that has been successfully bred and cultivated is the catfish (*Pangasius* sp.). In catfish farming, there are several water quality factors that need to be considered, such as temperature and dissolved oxygen levels. Erratic weather patterns cause poor water quality for fish farming, which makes fish susceptible to disease and if it continues will result in mass fish mortality. Based on the existing description, it is very important to pay attention to the water quality of aquaculture ponds, especially temperature and dissolved oxygen levels for fish survival. This study aims to create an internet of things based (IoT-based) monitoring system for temperature and dissolved oxygen levels in catfish aquaculture pond water based on NodeMCU ESP8266. Monitoring system is using SEN0237 gravity analog dissolved oxygen sensor, DS18B20 sensor module, NodeMCU ESP8266, 20x4 character LCD, Micro SD card module, internet modem. Data from measurements of temperature and dissolved oxygen levels are stored online in the Adafruit.io database in the .csv format and on a micro SD card in the device in the .txt format. The effective value of the probe filling solution on the SEN0237 analog dissolved oxygen sensor is around 3-4 hours. During the 3 days measurement, the lowest value of dissolved oxygen levels and temperature are 3,4 mg/L or 3.4 ppm and a temperature of 27,9°C, respectively. Meanwhile, the highest value of dissolved oxygen levels and temperature are 4,6 mg/L or 4,6 ppm and temperature of 30,9°C, respectively.

This is an open access article under the [CC BY-SA](#) license.



Corresponding Author:

Nurma Sari

Physics Study Program, University of Lambung Mangkurat

70714, Banjarbaru, Indonesia

Email: nurmasari01@ulm.ac.id

1. INTRODUCTION

Catfish is one of the native fish in Indonesian waters that grows well. Catfish is a freshwater fish that belongs to the catfish (*Pangasius* sp.) type. Pangasidae can be mass-produced and offers the potential for industrial-scale development due to its basic characteristics of lacking scales, having few spines, having a fairly fast growth rate, and having high fertility and survival rates. With all these benefits, this fish has increased economic value among fishery commodities, both in the hatchery and grow-out business sectors [1], [2]. In recent times, real time water quality monitoring in aquaculture has been brought by the fast development of Internet of Things (IoT) technology effectively. Globally, water quality monitoring systems based on IoT and wireless communication technologies have been widely studied intensively [3], [4], [5], [6], [7], [8], [9], [10], [11], [12], [13].

Dissolved oxygen levels are one of the water quality parameters that can cause large numbers of fish to die. The processes of decomposition, reproduction and development in ponds are hampered by low dissolved

oxygen levels. According to Indonesian National Standard (SNI 01-6483.3-2000) for catfish culture, dissolved oxygen levels range from >4 mg/L. The need for fish for dissolved oxygen levels depends on the age of the fish, fish activity, and water quality [14]. Dissolved oxygen levels in ponds vary from time to time. [15] research show that dissolved oxygen levels change due to the influence of changing temperatures due to unstable weather. According to [16], dissolved oxygen levels for fisheries must be at least 5 mg/L. If the concentration of dissolved oxygen is not balanced, the fish will be stressed because the brain does not get enough oxygen. Fish will experience anoxia because their body tissues are unable to bind dissolved oxygen in the blood.

The water temperature of fish farming ponds is an important factor. The ideal temperature tolerance range for catfish according to SNI 01-6483.3-2000 is between 25-30°C. Pool water temperature affects water quality [17]. Oxygen solubility is one of the characteristics of water quality that is affected by temperature variations. With increasing temperature, the level of solubility of oxygen decreases [18]; [19]. Once there is an increase in temperature, the amount of solubility of oxygen in water will decrease. An increase in temperature causes the metabolic activity of fish to be greater which results in a doubling of oxygen consumption in fish. Low water temperature can affect the ability of fish to bind oxygen so that it can inhibit fish development [20]. Fish that experience stress reduce stamina and reduce hunger, and eventually starve to death [16].

The DS18B20 temperature sensor is a device that can read temperature variations and then translate these changes into electrical quantities. This sensor is connected to the microcontroller using a single cable and is a digital sensor. These sensors are special because each sensor contains a serial code that allows the use of multiple DS18B20s in one-wire transmission. This sensor can be used with 3.0V to 5.5V. The sensor has $\pm 0.5^\circ\text{C}$ accuracy from -10°C to $+85^\circ\text{C}$ and can be used in the temperature range of -55 to 125°C (-67°F to $+257^\circ\text{F}$) with a resolution of 9 to 12 bits. [21]. SEN0237 gravity analog dissolved oxygen sensor is a sensor for measuring dissolved oxygen levels in water. These sensors are widely used in various water-related sectors, including research, aquaculture, and monitoring of the aquatic environment. This sensor is open source and compatible with various microcontrollers, allowing users to use it freely and openly. This sensor has a galvanic probe type with a detection range of 0 - 20 mg/L. This sensor has a response time of up to 98% full response, within 90 seconds (25 °C) sensor pressure range from 0 ~ 50PSI with electrode service life generally for 1 year for normal use [22]. NodeMCU ESP8266 is a microcontroller equipped with the ESP8266 chip. This microcontroller has multiple input or output ports to enable monitoring and control applications for IoT projects. The NodeMCU ESP8266 is an evolution of the ESP8266 version of the ESP-12 IoT (Internet of Things) platform module family. This module works very similarly to the Arduino module platform in terms of functionality, but the difference is "Connected to the Internet" [23].

Several studies that have been conducted regarding the measurement of water quality in aquaculture ponds. For instance, Mardhiya in 2017 was working on a data acquisition system for measuring dissolved oxygen levels with the results that the average DO level is in the range of 3 to 5 mg/L in rainy conditions and between 3 to 7 mg/L on cloudy conditions [24]. Next, research by Sumardiono, *et.al.* in 2020, was showing a system for monitoring temperature and dissolved oxygen levels in catfish ponds with the Raspberry Pi that was obtained the water temperature varied with time [25]. Furthermore, research by Suriana, *et.al.* in 2021 built a temperature remote monitoring system in Bangkok tilapia ponds, the effective temperature for fish pond water was an indicator of 28°C to 30°C [26]. To fill the needs of fish consumes, aquaculture methods have been forced to overproduce and resulting in the accelerated water environment degradation and the old of agricultural workers in many parts of the world so will face the dilemma of shortage of labor, and IoT aquaculture method is one of the method that can resolve the issue [27]. Fish farming has been applied widely recently. In Bangladesh, fish monitoring had been studied based on IoT so it notified the user the amount of dissolved oxygen, ammonia level, pH level, and water body temperature. It can help fish farmers to measure the parameters and provide necessary things to grow more fish and facing water pollution [28]. Latest research by Loh, *et.al.* [29] showed that to address the challenges of maintaining aquatic environment, IoT Fish Farm Monitoring System has been done to provide several features such as temperature, pH, Dissolved Oxygen (DO), total dissolved solid, and energy usage of the water pump.

Erratic weather patterns cause poor water quality for fish farming, which makes fish susceptible to disease and if it continues will result in mass fish mortality. Based on the existing description, it is very important to pay attention to the water quality of aquaculture ponds, especially temperature and dissolved oxygen levels for fish survival. In this research, a remote and Internet of Things (IoT) based monitoring system for temperature and dissolved oxygen levels in catfish farming ponds will be made using the DS18B20 and SEN0237 Gravity analog dissolved oxygen sensor internet-based sensors which will be tested and implemented in catfish farming ponds. This monitoring system uses NodeMCU ESP8266 as a microcontroller and Adafruit.io as an online interface. By applying IoT technology with an internet network, this up-to-date technology is able to send data and offer speed and a vast distance [30]. This research develops IoT technology

for sending parameter data from DO level and temperature directly to a web server. Then, the stored data for 24 hours on the webserver can be processed for further identification all the time.

2. RESEARCH METHOD

2.1 Material

The materials used are the sensor modules which are DS18B20 temperature sensor and SEN0237 gravity analog dissolved oxygen sensor. Next is the microcontroller kit that consists of NodeMCU ESP8266, 20x4 character LCD with I2C and SD card module. It is also supported by 12V 2A adapter, step down DC to DC converter, tin, electronic components, connecting cables and control panel box.

2.2 Method

2.2.a Hardware

The proposed of the NodeMCU ESP8266-based IoT monitoring system for temperature and dissolved oxygen consists of several stages starting with preparing the tools and materials needed in this research (Figure 1). It proceeds with assembling the hardware, namely integrating the NodeMCU ESP8266 with the sensor, and assembling a remote monitoring system for temperature and dissolved oxygen based on the NodeMCU ESP8266. Furthermore, the manufacture of software includes the manufacture of microcontroller software, manufacture of LCD interface software and manufacture of IOT software. Followed by determining the transfer function of measuring instruments, testing the system as a whole and finally data collection. The details of the proposed system can be seen clearly in Figure 1a. Meanwhile, Figure 1b shows layout of the circuit design of remote monitoring of temperature and dissolved oxygen levels based on Node MCU ESP8266. It is included SEN0237 analogue dissolved oxygen sensor, DS18B20 sensor, SD Card module and 20 x 4 characters I2C LCD module are integrated into the NodeMCU ESP8266.

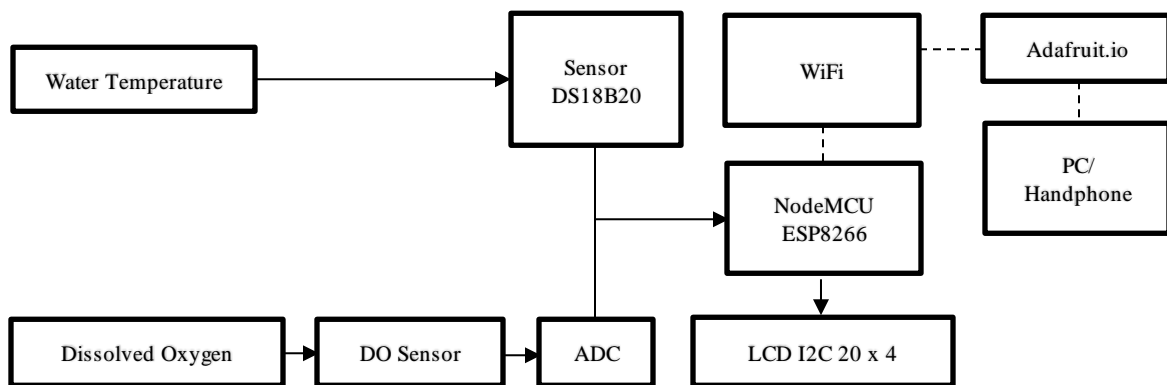

(a)

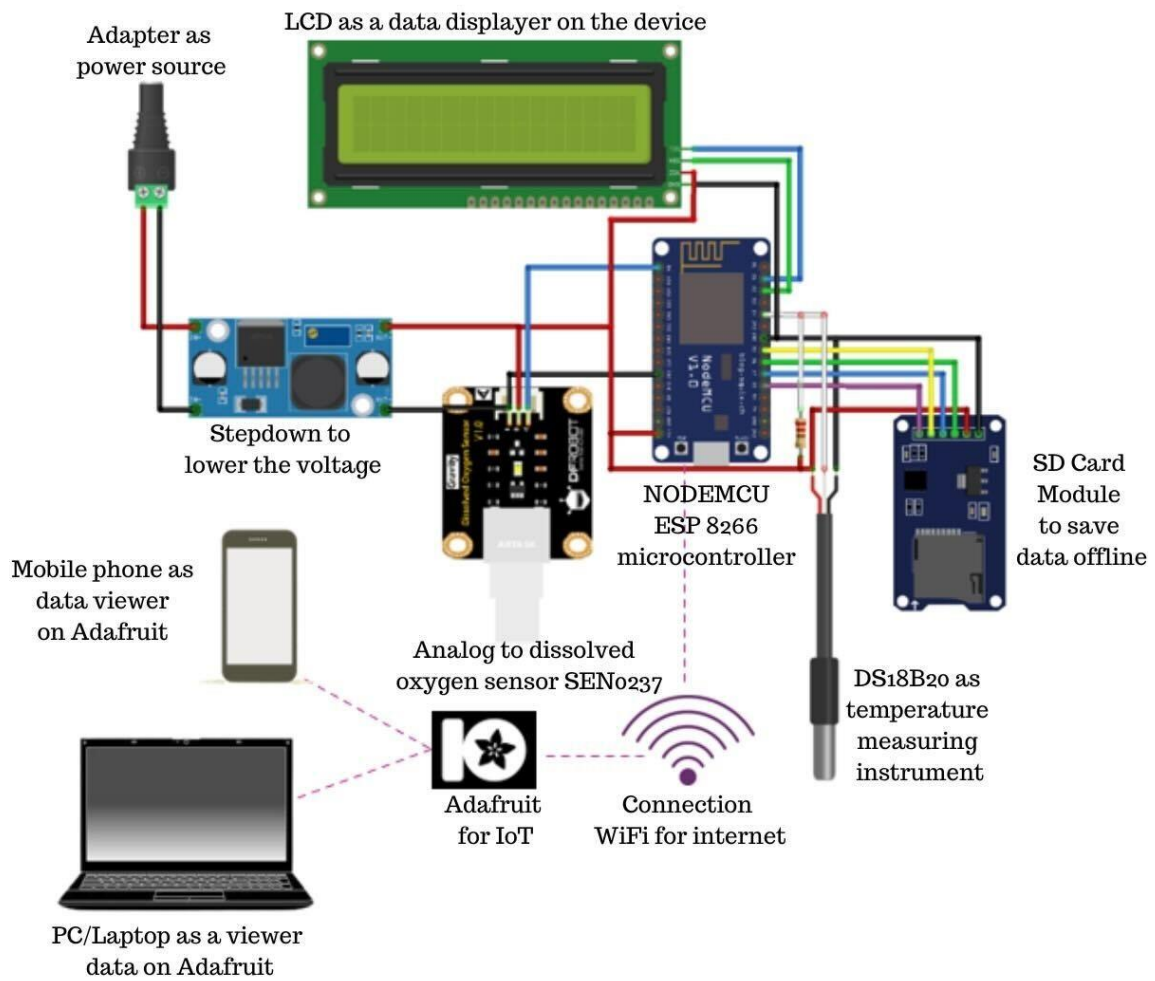

(b)

Figure 1. Proposed system, (a) Block diagram, (b) Circuit design

2.2.b Software

Figure 2 shows the function of NodeMCU ESP8266 for both with sensors and LCD and also with IoT. The software on NodeMCU ESP8266 is made using the Arduino IDE software. The software Interface to LCD using Arduino IDE software that connecting between NodeMCU ESP8266 and sensors (DS18B20 dan SEN0237 analog dissolved oxygen sensor). The stages include LCD pin configuration, library input, and giving commands to retrieve data from the output of the measuring instrument circuit. The flowchart of the programme interface to display characters on the LCD can be seen in Figure 2a.

Calibration was accomplished by comparing the measured value on the sensor with the measured value on a standard measuring instrument. For the DS18B20 sensor, a digital thermometer is used as a comparison. The measurement range used is 10°C to 50°C. Meanwhile, for the SEN0237 grativity analog dissolved oxygen sensor, a DO meter is used as a comparison. Measurements were made using zero dissolved oxygen powder which was added little by little until a measured DO value of 0 mg/L was obtained.

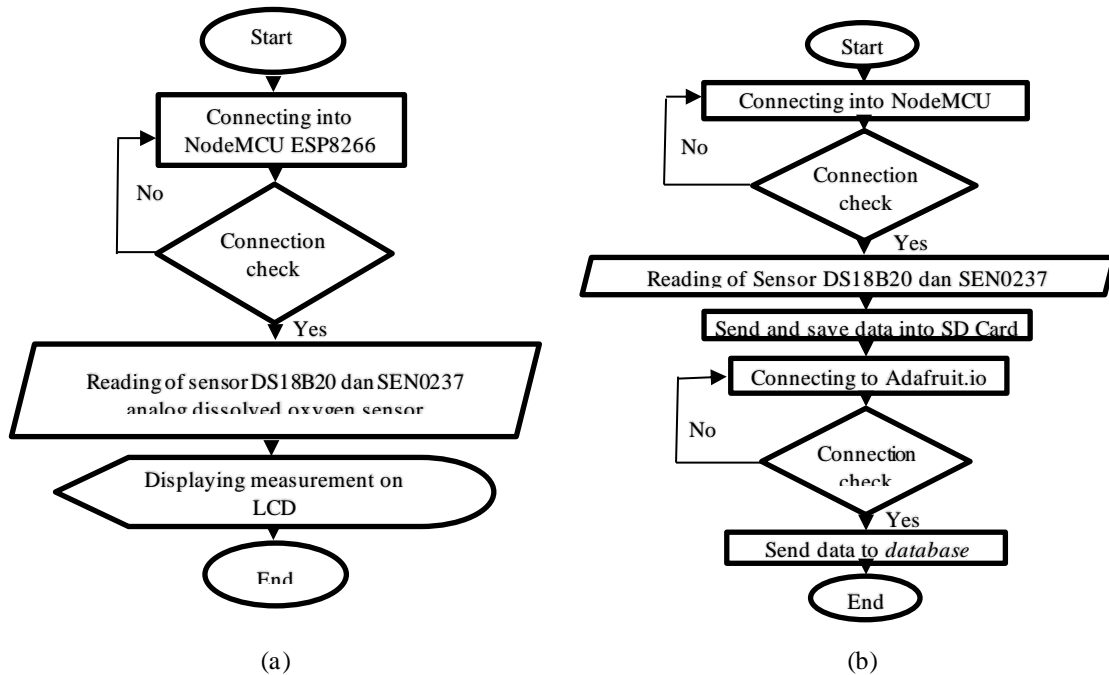

Figure 2. Flowchart of (a) NodeMCU ESP8266 with sensors and LCD, and (b) NodeMCU ESP8266 with IoT

Figure 2b presents connection of NodeMCU ESP8266 with IoT. The system developed by the Arduino IDE software and the IoT interface used Adafruit.io. In details, to connect NodeMCU ESP8266 with IoT, it is mandatory to write down the wifi name and password of the wifi used. To link readings to Adafruit.io, the listing should include the Adafruit.io web address, the username of the Adafruit.io account used, the active key, and the name of the feed used. The monitoring system that is made is tested first by observing each part whether it is working properly. Next, a performance check of the NodeMCU ESP8266 is carried out by connecting to the internet so that it reads Adafruit.io. After connected to the internet and a notification appears that Adafruit.io has been connected, a comparing the values between on the LCD of the device and Adafruit.io. Once the reading value of the measuring instrument that appears is appropriate, the tool can be used.

Calibration was accomplished by comparing the measured value on the sensor with the measured value on a standard measuring instrument. For the DS18B20 sensor, a digital thermometer is used as a comparison. The measurement range used is 10°C to 50°C with the sensor readings obtained, the following equation (1) is obtained:

$$y = 1,0129x + 0,2557 \text{ with } R^2 = 1 \quad (1)$$

Equation (1) is then entered into the Arduino program. It is intended that the readings from the DS18B20 sensor are the same as standard measuring instruments. After the equation is entered into the Arduino program, retesting is carried out with a temperature range of 20 ° C to 35 ° C as a representative of the reasonable limit for measuring catfish pond water. Data on the results of retesting the DS18B20 sensor can be seen in Table 1. Meanwhile, for the SEN0237 gravity analog dissolved oxygen sensor, a DO meter is used as a comparison. Measurements were made using zero dissolved oxygen powder which was added little by little until a measured DO value of 0 mg/L was obtained. Based on the sensor readings obtained, the following equation (2) is obtained:

$$y = 126,22x - 129,85 \text{ with } R^2 = 0,9664 \quad (2)$$

Equation (2) is then entered into the Arduino program. This aims to convert the reading from SEN0237 analog dissolved oxygen sensor into mg/L like the reading from DO meter. After the equation is entered into the Arduino program, a retest is carried out using PDAM water with calibration powder added little by little until the dissolved oxygen level in PDAM water becomes zero mg/L. The data of SEN0237 analog dissolved oxygen sensor retest can be seen in Table 2.

Table 1. DS18B20 Sensor Retest Result Data

No	Calibrator (\bar{x})	DS18B20 Sensor (\bar{x}_i)	Difference ($\bar{x}-\bar{x}_i$)	Error (%)
1	20	20	0	0.00
2	21	21.02	-0.02	0.10
3	22	22.03	-0.03	0.14
4	23	23.04	-0.04	0.17
5	24	23.99	0.01	0.04
6	25	25	0	0.00
7	26	26.02	-0.02	0.08
8	27	27.03	-0.03	0.11
9	28	28.04	-0.04	0.14
10	29	28.99	0.01	0.03
11	30	30.01	-0.01	0.03
12	31	31.02	-0.02	0.06
13	32	32.03	-0.03	0.09
14	33	33.04	-0.04	0.12
15	34	34.06	-0.06	0.18
16	35	35.01	-0.01	0.03
Error Mean				0.1

Table 1. Result of the retest Data on SEN0237 analog dissolved oxygen sensor

No	Calibrator (\bar{x})	SEN0237 Sensor (\bar{x}_i)	Difference ($\bar{x}-\bar{x}_i$)	Error (%)
1	6.50	6.82	-0.32	4.92
2	6.03	6.57	-0.54	8.9
3	5.90	6.07	-0.17	2.82
4	5.70	5.58	0.12	2.05
5	5.27	5.18	0.09	1.71
6	4.53	4.35	0.18	4.12
7	3.80	3.09	0.71	18.77
8	2.53	1.75	0.78	31.05
Error Mean				9.3

2.2.c System Realization

Figures 3 show the location and configuration of the equipment and its placement in the catfish farming pond. Pre-data collection was retrieved for 2 days to determine the readiness of the tool before the actual data collection was carried out. Pre-data collection was carried out during weather conditions after rain and in ponds with cloudy weather conditions accompanied by rain. Data monitoring can be monitored via mobile phones and laptops or other devices that can access the internet. To monitor the measurement results via the internet, users can open the link that has been provided for this monitoring system. Measurements will begin when the NodeMCU ESP8266 microcontroller is connected to the internet. The process of connecting the microcontroller to the internet takes ± 40 seconds depending on the speed of internet access. The better the internet network used, the faster the microcontroller is connected. If the internet network is disconnected, the data displayed is the last data before the network is disconnected. This monitoring system has a weakness in the DO sensor used, which is a probe filling solution sensor that must always be monitored. During the pre-

take, it is known that the effective use of the probe filling solution is about 3-4 hours. Therefore, every 3-4 hours it is necessary to check and replace the probe filling solution so that the measurement results obtained have a good value. The probe filling solution used should always be in good condition and no bubbles should form on the filling membrane. The formation of bubbles and poor probe filling solution can affect the measurement results.

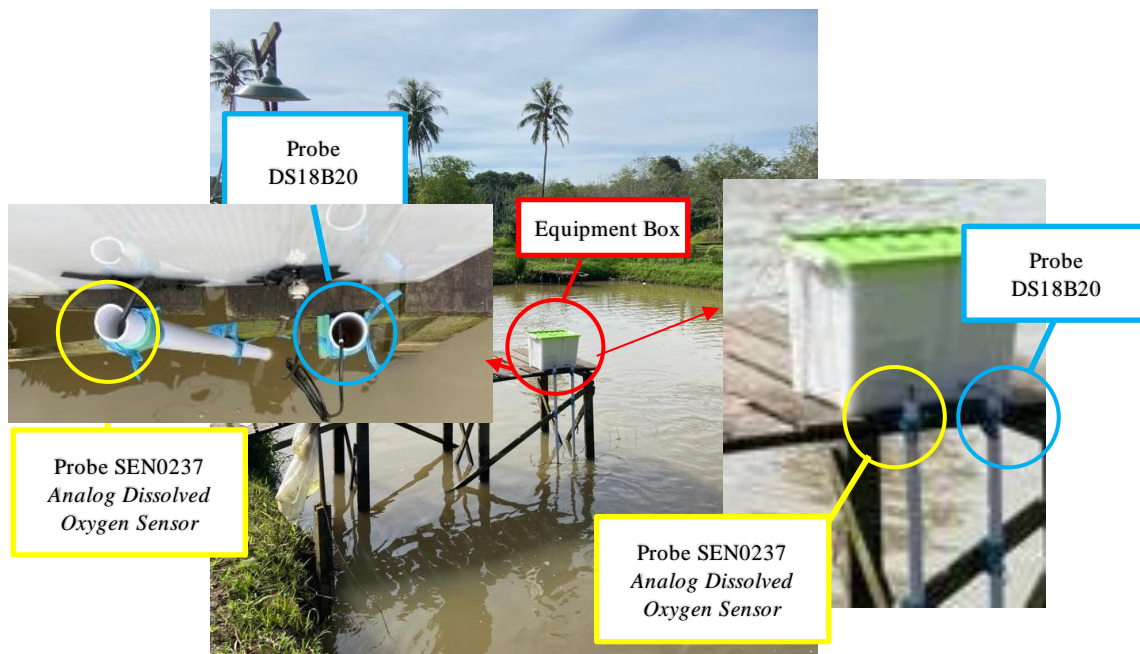

(c)

Figure 3. (a) Location of catfish ponds where data is collected, and (b) Measurement and IoT system processing equipment, and (c) IoT based monitoring system for temperature and dissolved oxygen levels in catfish farming ponds

Location of the ponds in this research can be clearly seen in Figure 3a. The laying tools in the field using a box that is given a hole and then associated with a paralon pipe tied to the bridge. The tool box, modem and power outlet (Figure 3b) are placed in a green box which is then given a hole for the sensor probe. The sensor probe is connected to the outside of the box and then inserted into the paralon pipe that has been tied to the bridge to prevent the position of the probe from moving if it is hit by a fish that has an impact on the measurement (Figure 3c).

3. RESULTS AND DISCUSSION

The calibration process of the SEN0237 analog dissolved oxygen sensor. Measurements were carried out three times using water mixed with zero dissolved oxygen powder until the dissolved oxygen level in the

water was zero mg/L. Based on the results of the sensor readings obtained the regression formula (Equation 2) and adapted into Arduino program. From the results of retesting conducted, it is known that the average error in sensor readings is 9.3% (Table 2). Meanwhile, based on the results of the DS18B20 temperature sensor during calibration, it is obtained the regression formula in Equation 1. This equation is then adapted into the Arduino program. It is intended that the readings from the DS18B20 sensor are the same as standard measuring instruments. From the results of retesting, it is known that the average error value of reading is 0.1% (Table 1).

The readings that appear on the Adafruit IO dashboard are temperature, dissolved oxygen (mg/L), and dissolved oxygen (ppm) in the form of images and gauges. Figure 4 is the interface display on Adafruit IO. The gauge is given a limit value, where if the dissolved oxygen value is below 4 mg/L or 4 ppm and the temperature is below 25 °C and more than 30 °C then the gauge will turn red as a sign that the measurement was carried out in a condition that is not in accordance with SNI 01-6483.3-2000. Meanwhile, when the measurement results are >4 mg/L or 4 ppm for dissolved oxygen and the temperature is around 25-30°C, the gauge will turn green. Data display indicators for monitoring can be said to be real-time if the interface for sensor readings that appear on the LCD and the Adafruit.io dashboard is "same". Figure 5 shows the real-time readings of the Adafruit.io LCD and dashboard.



Figure 4. Adafruit.io display developed



Figure 5. Testing and validating of the IoT-based monitoring system

Data measurement from the downloaded of Adafruit.io database is in CSV file format, while stored on the micro SD card is in The TXT file format (Figure 6). Data stored in the Adafruit.io database can be downloaded in CSV (Comma Separated Value) file format for each feed (Figure 6a). Along side stored online in the Adafruit.io database, measurement data is also stored offline on a micro SD card in the form of a TXT file. The stored data contains time data, SEN0237 analog dissolved oxygen sensor readings in mg/L and ppm units, as well as DS18B20 sensor module readings which are separated by commas “;”. This data can be converted into an spreadsheet table for comparative image analysis. Figure 6b shows the TXT file data written to and stored on the micro SD card.

(a)

A	B	C	D	E	F	G	H
1	id,value,feed_id,created_at,lat,lon,ele						
2	0F8ZMYT63POV2GJ9JWNSPJRBGTG,1.03,2490571,2023-03-30 05:29:32 UTC,,,						
3	0F8ZMYX9RQ71RJS5D2819HWWBP4,1.03,2490571,2023-03-30 05:29:42 UTC,,,						
4	0F8ZMZ0D7XFMCCGJ56Z27G1X1,1.03,2490571,2023-03-30 05:29:52 UTC,,,						
5	0F8ZMZ3G3WVG11VKYRE03KHFVR1,1.03,2490571,2023-03-30 05:30:02 UTC,,,						
6	0F8ZMZ6K65RCQG8P81XCD049H,1.03,2490571,2023-03-30 05:30:13 UTC,,,						
7	0F8ZMZ9NM9YTEVP59YJCVQGG8H,1.03,2490571,2023-03-30 05:30:23 UTC,,,						
8	0F8ZMZCCQTHNW030T3QVFW3F2C2,1.03,2490571,2023-03-30 05:30:33 UTC,,,						
9	0F8ZMZFT28NG7W7Q6YMSC29QG8,1.03,2490571,2023-03-30 05:30:43 UTC,,,						
10	0F8ZMZJW5G776GYHRJZ6QVZ1G,1.03,2490571,2023-03-30 05:30:53 UTC,,,						
11	0F8ZMZQ7F1KRJZTF58KN89G3D9,1.03,2490571,2023-03-30 05:31:07 UTC,,,						
12	0F8ZMZ565WW112NY6J4J7NQ1SH,1.03,2490571,2023-03-30 05:31:14 UTC,,,						
13	0F8ZMZ8X8GYP13WVHDMQ9K8E,1.03,2490571,2023-03-30 05:31:24 UTC,,,						
14	0F8ZMZ2CRTJ0T7X7QA22E4G56A,1.03,2490571,2023-03-30 05:31:34 UTC,,,						
15	0F8ZMN02G2QNNQZV9NTYB91B2,1.03,2490571,2023-03-30 05:31:44 UTC,,,						
16	0F8ZMN05KEF90C2MPM4N9GH38R0,1.03,2490571,2023-03-30 05:31:54 UTC,,,						
17	0F8ZMN08RX8GYP13WVHDMQ9K8E,1.03,2490571,2023-03-30 05:32:05 UTC,,,						
18	0F8ZNB0VAN67691EXCR2PWI1MSA,1.03,2490571,2023-03-30 05:32:15 UTC,,,						
19	0F8ZNB0EXF512BKBP2KM5DYN8Y9,1.03,2490571,2023-03-30 05:32:25 UTC,,,						
20	0F8ZNB0J07TEP5153C587WY2JHC,1.03,2490571,2023-03-30 05:32:35 UTC,,,						
21	0F8ZNB0N41R9GZM31V42YCT0JT,1.03,2490571,2023-03-30 05:32:45 UTC,,,						

(b)

File	Edit	View
Waktu,Dissolved Oxygen (mg/L),Waktu,Dissolved Oxygen (ppm).		
07:27:19,2.55,2.55,26.91		
07:27:30,2.50,2.50,27.73		
07:27:40,2.55,2.55,27.67		
07:27:50,2.47,2.48,27.67		
07:28:00,2.52,2.52,27.67		
07:28:10,27.37,27.40,27.67		
07:28:21,8.79,8.80,27.60		
07:28:31,7.84,7.85,27.54		
07:28:41,7.48,7.49,27.35		
07:28:51,7.48,7.49,27.16		
07:29:01,7.05,7.05,27.35		
07:29:12,4.95,4.96,27.22		
07:29:22,3.96,3.96,27.79		
07:29:32,3.50,3.50,27.79		
07:29:42,3.52,3.52,27.86		
07:29:52,3.39,3.40,-128.38		
07:30:03,3.39,3.40,27.86		
07:32:53,3.50,3.50,27.86		
07:34:34,3.27,3.27,27.86		
07:34:44,3.34,3.34,27.86		
07:37:06,3.29,3.29,27.86		

Figure 6. Display of measurement results data of (a) The downloaded from the Adafruit.io database in CSV file format, and (b) The TXT file data written to and stored on the micro SD card

Data collection was retrieved for three days (Figure 7). The measuring instrument is placed on a bridge with a height of ± 80 cm from the water surface with the sensor probe submerged about 2–4 cm from the water surface. During data collection, the weather is constantly changing. Data collection on first day was in cloudy weather conditions accompanied by rain during the day. The relationship between temperature and dissolved oxygen levels from data collection on the first day can be seen in Figure 7a. From the figure it is known that when the temperature increases the dissolved oxygen levels decrease and vice versa. From the figure 7a, the relationship between temperature and dissolved oxygen levels is most clearly seen at point a at 13.15, where the DO value reaches 4.5 mg/L or 4.5 ppm with a measured temperature of 28.6 °C. It also shows a decrease in DO values and temperature due to rain during the day, from 13.15 to 14.30. Apart from when it rains, DO values and measured temperatures also tend to decrease at night at 19.15. The DO value measured after rain and at night fell below 4 mg/L.

Data collection on second day was cloudy in the morning, then hot during the day and cloudy again in the late afternoon. Figure 7b is a graph of the relationship between temperature and dissolved oxygen levels. From the figure it is known that when the temperature increases the dissolved oxygen level decreases and vice versa as seen at 19.30 to 20.00. In some conditions there are temperature values that are not in accordance with the theory, such as at points d to e where the temperature values measured exceed the value of 30 °C at 13.00 to 17.30 caused by the hot sun during the day. The DO value between 10.00 and 11.30 is measured to be less than 4 mg/L in the morning with cloudy weather conditions after rain. The low DO value measured is the DO value measured at the time of changing the probe filling solution because when changing the probe is removed from the water. The low DO measured, aside from the effect of temperature, is also caused by other factors such as the water level and the water content.

Data collection on third day in sunny weather conditions in the morning then hot during the day, cloudy in the late afternoon accompanied by rain at night. Figure 7c is a graph of the relationship between temperature and dissolved oxygen levels. The figure during the temperature increases the dissolved oxygen levels decrease and vice versa. The relationship between temperature and dissolved oxygen can be seen at 15.45 to 17.15 once DO increases the temperature value decreases. In some conditions there are temperature values measured outside the limits of SNI provisions at 11.30 to 16.30 with the measured values are more than 30 °C. This condition occurs due to the hot weather during the day that causes the temperature to increase. DO values that were measured outside the regulatory limits were seen between 10.00 and 10.45 and at 17.15 to 20.00, where DO values were measured below 4 mg/L. The low DO measured apart from temperature is also caused by other factors such as water level and water content. From the data image, the most obvious one is at 14.00 where the DO value reaches 4.2 mg/L or 4.2 ppm with a measured temperature of 30.9 °C.

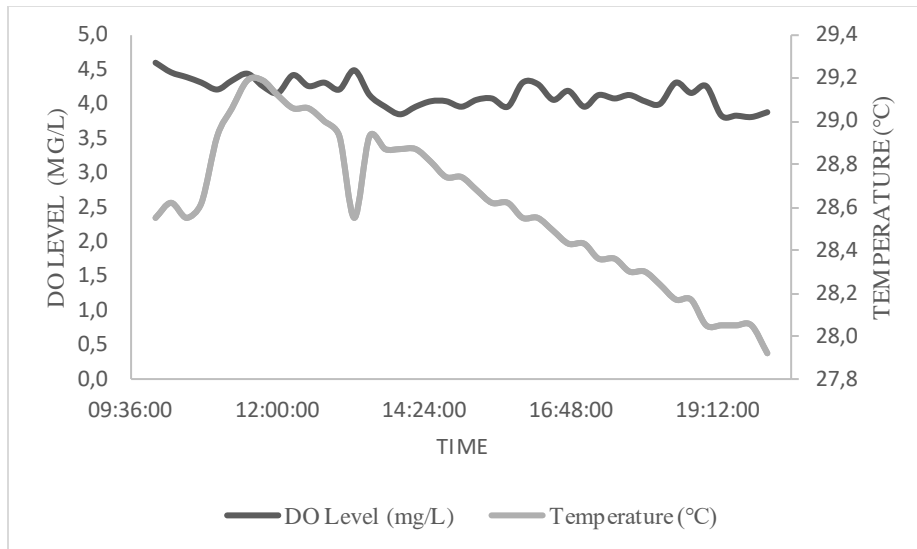

(a)

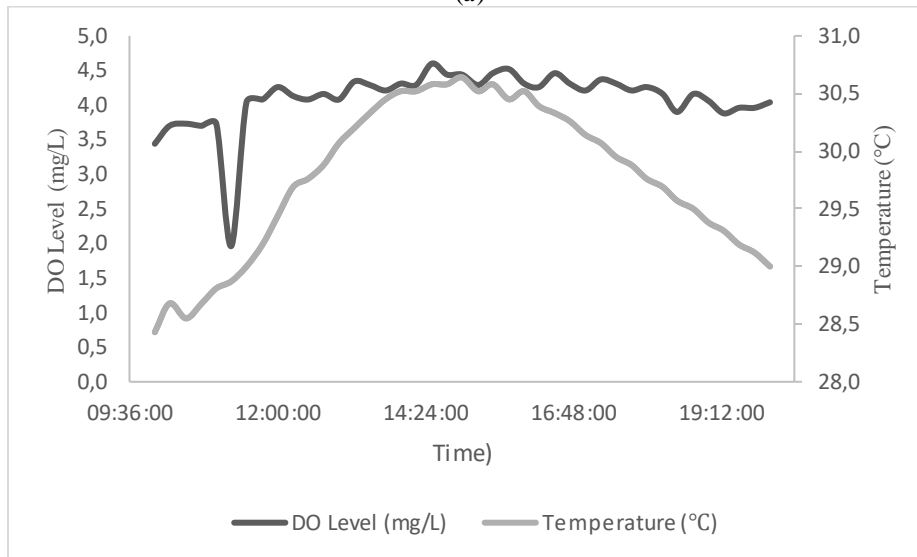

(b)

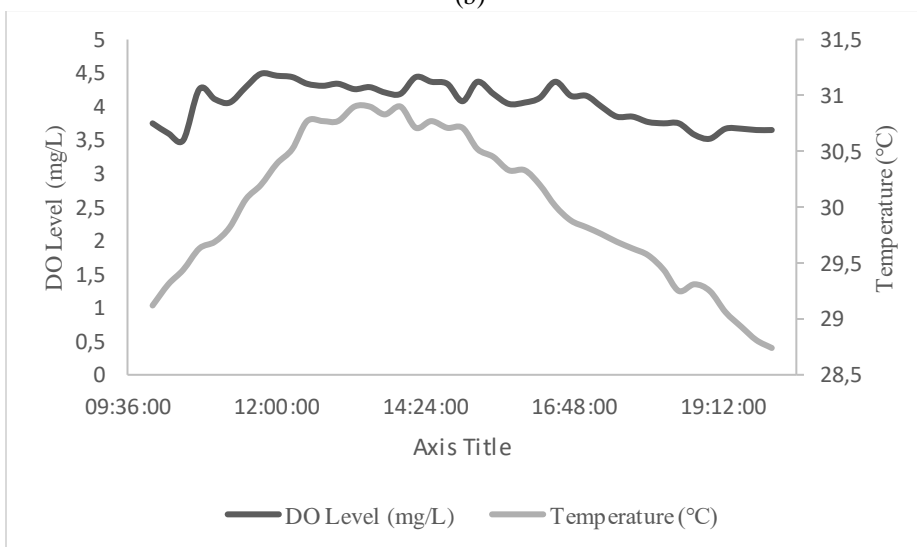

(c)

Figure 7. Data collection of DO Level (black line) and Temperature (gray line) for three days, (a) First day data collection, (b) Second day data collection, and (c) (a) Third day data collection,

Based on measurements carried out for three days, from 10.00 to 20.00 (Table 3), it is known that the temperature and DO values of the Karang Intan catfish pond are relatively safe and quite good. In the morning DO in fish pond water is quite low, then it increases as the day progresses. When it rains, the measured DO levels also decrease. This is similar to research conducted by Mardhiyana (2017) which obtained an average DO level in the range of 3 to 5 mg/L in rainy conditions and a range of 3 to 7 mg/L in cloudy conditions. Abundant oxygen levels during the day with sunny weather due to the process of respiration by macrophytes in the mechanism of photosynthesis with the help of sunlight. While at night DO decreased again. The decrease in dissolved oxygen levels at night is due to the absence of photosynthesis at night, also caused by the level of temperature fluctuations by the air, the increased respiration rate of sediment by bacteria and the more intense respiration rate in fish ponds by aquatic organisms. As for the temperature, it is influenced by the surrounding conditions. As the day gets darker, when the weather is cloudy and it rains, the measured temperature decreases and vice versa, when the weather is sunny and the sun is hot enough, the measured temperature increases. This is similar to research conducted by Sumardiono (2020), for example when it is sunny the temperature will rise to around 29°C, when it is foggy it will drop to around 27.7°C, and at night it will generally drop to around 29.4°C. The graph of the maximum and minimum values of DO and temperature measured for 3 days can be seen in Figure 8.

Table 3. Maximum and Minimum Values of Data for Three Days of Measurement

Day	DO (mg/L)				Temperature (°C)			
	Time	Max	Time	Min	Time	Max	Time	Min
1	10:00:01	4.6	19:45:01	3.81	11:45:09	29.19	20:00:37	27.92
2	14:30:15	4.6	10:00:42	3.44	15:00:09	30.64	10:00:42	28.43
3	11:45:20	4.49	10:30:05	3.5	13:30:38	30.9	20:00:12	28.74

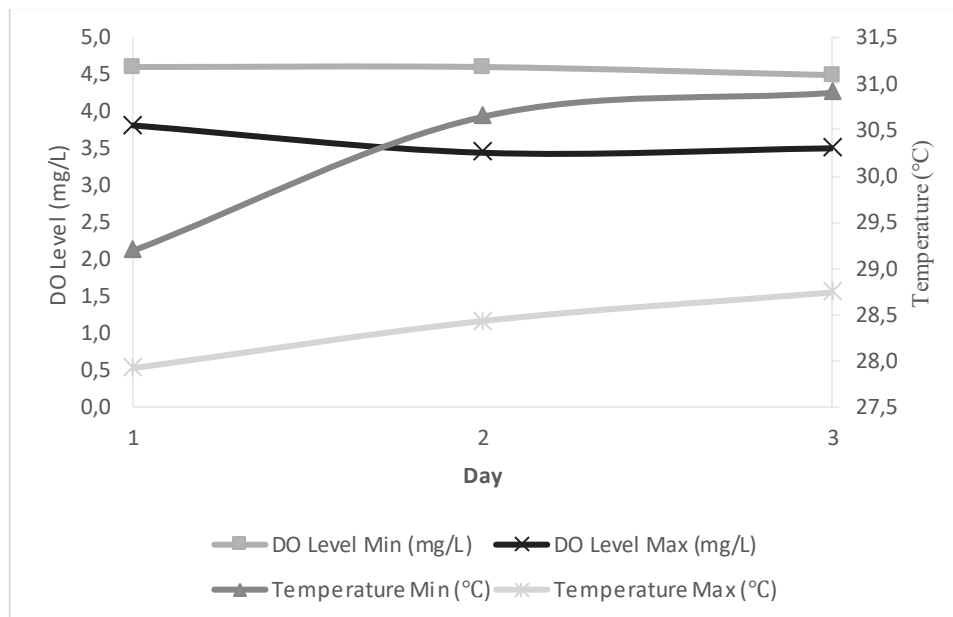

Figure 8. The maximum and minimum values of DO Level and temperature of 3 days of measurement

In Figure 8 it can be seen that DO tends to be lower in the morning, then increases as the day progresses. During 3 days the measurement was carried out, the dissolved oxygen levels and temperature measured during the measurement had the lowest value of 3.44 mg/L or 3.44 ppm with a temperature of 27.92°C and the highest value of 4.6 mg/L or 4.6 ppm with a temperature of 30.9°C. From the measurements taken, it is known that dissolved oxygen levels have good values during the daytime, while in the morning and night have poor values. The maximum value of DO that was measured was obtained at 10.00, 14.30 and 11.45. At night DO tends to decrease, where from the data obtained it is recorded that the minimum DO value is at 19.45, 10.00 and 10.30. Meanwhile, the temperature tends to increase during the day and decreases in the afternoon until the evening. From the data recorded from measurements for three days, it was found that the temperature experienced a maximum value at 11.45, 15.00 and 13.30. The minimum temperature recorded is at 20.00 and 10.00. The low temperature measured in the morning is caused by temperature changes that occur

at night accompanied by rain, so that when measurements are taken in the morning the measured temperature tends to be low. From the measurement data obtained, it is known that dissolved oxygen levels are indeed affected by temperature, but this factor does not have a significant effect. There are other factors that affect dissolved oxygen levels in fish pond water. Even so, the water quality measured in the catfish pond is fairly good because the DO and measured temperatures are still within safe limits. The circulation of fish pond water is quite good so that even though the measured DO was below the SNI 01-6483.3-2000 standard for catfish cultivation, DO can again increase to the threshold according to SNI 01-6483.3-2000.

This system also spent a low cost for its operation. In details, for the distilled water solution as a neutralizer or rinsing probes before and after use, approximately 500ml of distilled water is enough for one week of data collection. As for probe filling or NaOH liquid, approximately 30 ml is enough for one week of data collection. Cost calculation for 1 week, 500 ml of distilled water costs USD 0.45 and 30 ml of 0.5 molar NaOH costs USD 0.032 so the total cost for 1 week is USD 0.48. (USD 1 = IDR 15719).

4. CONCLUSION



















An IoT-based monitoring system for temperature and dissolved oxygen levels in catfish farming ponds using the DS18B20 and an internet-based DO sensor has been successfully developed. This monitoring system are able to measure temperature and dissolved oxygen levels which have a reading error value for the DS18B20 sensor of 0.1% and for the SEN0237 analog dissolved oxygen sensor 9.3%. The effective value of the probe filling solution on the SEN0237 analog dissolved oxygen sensor is around 3-4 hours. A water quality monitoring system has been implemented in catfish pond in Karang Intan for 3 days starting from 10.00 to 20.00. From the measurements that have been made, it is obtained that the dissolved oxygen level and temperature measured during the measurement have the lowest value of 3.4 mg/L or 3.4 ppm with a temperature of 27.9 °C and the highest value of 4.6 mg/L or 4,6 ppm with a temperature of 30.9 °C. The main limitation of the DO sensor is the effective use of the probe filling solution is about 3-4 hours. Therefore, every 3-4 hours it is necessary to check and replace the probe filling solution. In the future, DO sensor replacement with longer lifetime of used for the probe filling solution replacement. This future research also using photovoltaic cells as independent energy to supply to system so it can be implemented into remote ponds that are una valaible electricity source.

REFERENCES

- [1] Idawati, N. Defira, and S. Mellisa, 'The Effect of Different Life Feed on Growth and Survival of Eatfish Fry (Pangasius sp.)', *J. Ilm. Mhs. Kelaut. dan Perikan. Unsyiah*, vol. 3, no. 1, pp. 14–22, 2018.
- [2] Y. Sukrismon, Aripriharta, N. Hidayatullah, N. Mufti, A. N. Handayani, and G. J. Horng, 'Smart Fish Pond for Economic Growing in Catfish Farming', in *Proceedings - 2019 International Conference on Computer Science, Information Technology, and Electrical Engineering, ICOMITEE 2019*, 2019, vol. 1, pp. 49–53, doi: 10.1109/ICOMITEE.2019.8921233.
- [3] D. S. Simbeye and S. F. Yang, 'Water Quality Monitoring and Control for Aquaculture Based on Wireless Sensor Networks', *J. Networks*, vol. 9, no. 4, pp. 849–849, 2014.
- [4] L. Xu, N. Wang, Y. Feng, D. Bao, and K. Jorshin, 'Design of Aquaculture System based on Wireless Monitoring and its Testing', *Int. J. Online Eng.*, vol. 10, no. 5, pp. 68–73, 2014.
- [5] L. Hongpin, L. Guanglin, P. Weifeng, S. Jie, and B. Qiuwei, 'Real-time remote monitoring system for aquaculture water quality', *Int. J. Agric. Biol. Eng.*, vol. 8, no. 6, pp. 136–143, 2015, doi: 10.3965/j.ijabe.20150806.1486.
- [6] C. Encinas, E. Ruiz, J. Cortez, and A. Espinoza, 'Design and implementation of a distributed IoT system for the monitoring of water quality in aquaculture', *Wirel. Telecommun. Symp.*, 2017, doi: 10.1109/WTS.2017.7943540.
- [7] M. Zhang, D. Li, L. Wang, D. Ma, and Q. Ding, 'Design and development of water quality monitoring system based on wireless sensor network in aquaculture', *IFIP Adv. Inf. Commun. Technol.*, vol. 347 AICT, no. PART 4, pp. 629–641, 2017, doi: 10.1007/978-3-642-18369-0_76.
- [8] S. Saha, R. H. Rajib, and S. Kabir, 'IoT Based Automated Fish Farm Aquaculture Monitoring System', in *2018 International Conference on Innovations in Science, Engineering and Technology, ICISSET 2018*, 2018, no. August 2019, pp. 201–206, doi: 10.1109/ICISSET.2018.8745543.
- [9] C. Dupont, P. Cousin, and S. Dupont, 'IoT for aquaculture 4.0 smart and easy-to-deploy real-time water monitoring with IoT', IEEE, 2018.
- [10] L. Parra, S. Sendra, L. García, and J. Lloret, 'Design and deployment of low-cost sensors for

- monitoring the water quality and fish behavior in aquaculture tanks during the feeding process', *Sensors (Switzerland)*, vol. 18, no. 3, pp. 1–23, 2018, doi: 10.3390/s18030750.
- [11] M. Li, C. Lin, J. Ren, and F. Jiang, 'A Wireless Ecological Aquaculture Water Quality Monitoring System Based on LoRa Technology', in *Advances in Computer Science Research, International Conference on Wireless Communication, Network and Multimedia Engineering (WCNME 2019)*, 2019, vol. 89, pp. 5–7, doi: 10.2991/wcnme-19.2019.2.
- [12] F. A. Saparudin, T. C. Chee, A. S. Ab Ghafar, H. A. Majid, and N. Katiran, 'Wireless water quality monitoring system for high density aquaculture application', *Indones. J. Electr. Eng. Comput. Sci.*, vol. 13, no. 2, pp. 507–513, 2019.
- [13] L. V. Q. Danh, D. V. M. Dung, T. H. Danh, and N. C. Ngon, 'Design and deployment of an IoT-Based water quality monitoring system for aquaculture in mekong delta', *Int. J. Mech. Eng. Robot. Res.*, vol. 9, no. 8, pp. 1170–1175, 2020, doi: 10.18178/ijmerr.9.8.1170-1175.
- [14] Y. Fujaya, *Fisiologi Ikan: Dasar Pengembangan Teknologi Perikanan*, no. 1. Rineka Cipta. Jakarta, 2004.
- [15] W. H. Siegers, Y. Prayitno, and A. Sari, 'Pengaruh Kualitas Air Terhadap Pertumbuhan Ikan Nila Nirwana (*Oreochromis Sp.*) Pada Tambak Payau', *J. Fish. Dev.*, vol. 3, no. 11, pp. 95–104, 2019.
- [16] H. Effendi, *Telaah Kualitas Air Bagi Pengelolaan Sumber Daya dan Lingkungan Perairan*. Yogyakarta: Kanisius, 2003.
- [17] J. S. Lucas and P. C. Southgate, *Aquaculture: Farming aquatic animals and plants*. John Wiley & Sons, 2012.
- [18] D. A. Chin, *Water-Quality Engineering in Natural Systems*. 2006.
- [19] R. Parker, 'Review of life cycle assessment research on products derived from fisheries and aquaculture: a report for Seafish as part of the collective action to address greenhouse gas emissions in seafood.', 2012.
- [20] C. E. Boyd and F. Lichtkoppler, *Water Quality Management in Pond Fish Culture International Center for Aquaculture Agricultural Experiment Station*, no. 22. Project: AID/DSAN-G 0039, 1979.
- [21] Datasheet DS18B20, 'Programmable Resolution 1-Wire Digital Thermometer'. p. 1, 2015.
- [22] Dfrobot, 'Gravity : Analog Dissolved Oxygen Sensor SKU : SEN0237'. p. 8, 2018.
- [23] B. Satria, 'IoT Monitoring Suhu dan Kelembaban Udara dengan Node MCU ESP8266', *sudo J. Tek. Inform.*, vol. 1, no. 3, pp. 136–144, 2022, doi: 10.56211/sudo.v1i3.95.
- [24] I. R. Mardhiya, 'Sistem Akuisisi Data Pengukuran Kadar Oksigen Terlarut Pada Air Tambak Udang Menggunakan Sensor Dissolve Oxygen (DO)', 2017.
- [25] A. Sumardiono, S. Rahmat, E. Alimudin, and N. A. Ilahi, 'Sistem Kontrol-Monitoring Suhu dan Kadar Oksigen pada Kolam Budidaya Ikan Lele', *JTERA (Jurnal Teknol. Rekayasa)*, vol. 5, no. 2, p. 231, 2020, doi: 10.31544/jtera.v5.i2.2020.231-236.
- [26] Suriana, A. P. Lubis, and E. Rahayu, 'Sistem Monitoring Jarak Jauh Pada Suhu Kolam Ikan Nila Bangkok Memanfaatkan Internet of Things (IoT) Berbasis NODEMCUESP8266', *JUTSI J. Teknol. dan Sist. Inf.*, vol. 1, no. 1, pp. 1–8, 2021, doi: 10.1093/oseo/instance.00196643.
- [27] C. Wang, Z. Li, T. Wang, X. Xu, X. Zhang, and D. Li, 'Intelligent fish farm—the future of aquaculture', *Aquac. Int.*, vol. 29, no. 6, pp. 2681–2711, 2021, doi: 10.1007/s10499-021-00773-8.
- [28] A. T. Tamim, H. Begum, S. A. Shachcho, M. M. Khan, B. Yeboah-Akouwah, M. Masud and J. F. Al-Amri, 'Development of IoT Based Fish Monitoring System for Aquaculture', *Intell. Autom. Soft Comput.*, vol. 32, no. 1, pp. 55–71, 2022, doi: 10.32604/IASC.2022.021559.
- [29] S. H. Loh, P. C. Teh, G. Y. Goay, and J. J. Sim, 'Development of an IoT-based Fish Farm Monitoring System', in *2023 IEEE 13th International Conference on Control System, Computing and Engineering (ICCSCE)*, 2023, pp. 281–286, doi: 10.1109/iccsce58721.2023.10237168.
- [30] A. C. Subrata, T. Sutikno, Sunardi, A. Pamungkas, W. Arsadiando, and A. R. C. Baswara, 'A laboratory scale IoT-based measuring of the solar photovoltaic parameters', *Int. J. Reconfigurable Embed. Syst.*, vol. 11, no. 2, pp. 135–145, 2022, doi: 10.11591/ijres.v11.i2.pp135-145.

BIOGRAPHIES OF AUTHORS

	<p>Nurma Sari    received the Bachelor's degree in Physics (1996) from University of Diponegoro (UNDIP) and a masters degree in Physics (2007) specializing in waveguide antenna from Institut Teknologi Sepuluh Nopember (ITS). She received Doctoral degree in Physics (2022) at Institut Teknologi Sepuluh Nopember (ITS), Indonesia, funded by BUDI-DN LPDP Indonesia. Her interdisciplinary research interests focus on applying Physics, applying electromagnetics, applying optics and waveguide antenna. She can be contacted at email: nurmasari01@ulm.ac.id.</p>
	<p>Yuniar Savitri    was born in Banjarmasin in 2001. Her educational history went to MIN Langkai Palangkaraya, MTsN 1 Model Palangkaraya, MAN Kota Palangkaraya (2019) and completed his studies in the Bachelor's degree in Physics (2023) in the field of Instrumentation at the University of Lambung Mangkurat. His research interests focus on electronics and Instrumentation of Physics. She can be contacted at email: yuniarsavitri147@gmail.com.</p>
	<p>Sri Cahyo Wahyono    received the Bachelor's degree in Physics (1997) from University of Diponegoro (UNDIP) and a masters degree in Physics (2004) specializing in waveguide antenna from Institut Teknologi Sepuluh Nopember (ITS), Indonesia, funded by DIKTI Indonesia. His interdisciplinary research interests focus on applying physics and geophysics. He can be contacted at email: scwahyono@ulm.ac.id.</p>
	<p>Joko Santoso    received the Bachelor's degree in Physics (2019) from University of Lambung Mangkurat (ULM). He is currently a technician in instrumentation and computational physics laboratories at University of Lambung Mangkurat, Indonesia. He can be contacted at email: jokosantoso1507@gmail.com.</p>
	<p>Amar Vijai Nasrulloh    received an undergraduate degree in Physics (2004) from Institut Teknologi Sepuluh Nopember (ITS) and a masters degree in Electrical Engineering (2010) specializing in Biomedical Engineering from Institut Teknologi Bandung (ITB) and a PhD degree in Bioimage Informatics from Durham University, UK, funded by LPDP Indonesia. He is currently a lecturer in Physics Study Program at University of Lambung Mangkurat, Indonesia. His interdisciplinary research interests focus on applying physics and image processing methods to biology and medicine. He can be contacted at email: amarvijai01@ulm.ac.id.</p>



Fwd: [Paper ID# 21040] Final version of the paper and similarity index

1 message

Amar Vijai Nasrulloh <amarvijai01@ulm.ac.id>
To: Nurma Sari <nurmasari01@ulm.ac.id>

Mon, Jan 15, 2024 at 8:27 AM

----- Forwarded message -----

From: **IJRES Editor** <ijres@iaesjournal.com>
Date: Fri, Dec 22, 2023 at 3:17 PM
Subject: Re: [Paper ID# 21040] Final version of the paper and similarity index
To: Amar Vijai Nasrulloh <amarvijai01@ulm.ac.id>

--Paper ID # 21040

--We usually want at least 25 references, most of which should be to journal papers (for research papers).

--IJRES Author Guidelines and Template: <http://www.iaescore.com/gfa/ijres.docx>

--Please send us your similarity report. You can use software like iThenticate or Turnitin to make sure that the result is below 20%. If the similarity index is more than 20%, the paper will not be published when planned or at all.

--Your final paper needs to be turned in within 6 weeks!

Dear Prof/Dr/Mr/Mrs: Amar Vijai Nasrulloh,

Your article titled "Design of IoT-based Monitoring System for Temperature and Dissolved Oxygen Levels in Catfish Aquaculture Pond Water" has been accepted for publication in the International Journal of Reconfigurable and Embedded Systems (IJRES), p-ISSN 2089-4864, e-ISSN 2722-2608, a peer-reviewed and open access journal distributed under the terms and conditions of the Creative Commons Attribution-ShareAlike 4.0 International License, and indexed by Scopus (<https://www.scopus.com/sourceid/21101061447>). This journal has been included in the SCImago Journal Rank (SJR, <https://www.scimagojr.com/journalsearch.php?q=21100901206&tip=sid&clean=0>) and has an SJR of 0.218 (Q3). Congratulations!

Please submit your final work along with your similarity report and proof of payment to IJRES@IAESJOURNAL.COM within six weeks. Highlight your contribution to the field of reconfigurable systems, embedded systems, VLSI design, or the internet of things (IoT). In your final work, you must strictly adhere to the authors' guide (<http://iaescore.com/gfa/ijres.docx>) and the checklist (<https://s.id/c1sSy> or <http://iaescore.com/gfa/ijres.docx>).

Make sure to complete the biographies of authors as our template (include links to the 4 authors' profiles, do not delete any icons in the template). Provide links for all authors to the 4 icons (Scholar, Scopus, Publons and ORCID). It is mandatory!!

Instead of using different colors to convey different results in your graphics, use different patterns. Using software such as iThenticate or Turnitin, the similarity rate should be determined (that the result is less than 20 percent). If the similarity index is greater than 20%, your manuscript will be delayed for publication until it falls below 20%.

When you send in all of the above documents and your final paper follows all of the final instructions, your paper will be judged "fully accepted." It will be the date of your paper's acceptance.

Your cooperation is very appreciated.

Thank you

Best Regards,
Assoc. Prof. Dr. Selvakumar Manickam
Editor-in-Chief, IJRES
ijres@iaesjournal.com

A high-quality research report MUST have the following elements:

- (1) a clear definition of the problem addressed by the study --> explain in the "Introduction" section
- (2) the suggested solution(s), method(s), approach(es), framework(s), algorithm(s), etc.

(3) Achieved outcomes It thoroughly discusses previous work on the subject as well as what is new.

This journal is free and accessible to the public. Why publish open access? IAES open access writers gain from the following: a quality, established, and respected publication, reaching crucial audiences with 5 million readers each month, high citations, and so on. So, the open access fee is paid by the authors, or on their behalf, to support the cost of wide open access dissemination of research results; to pay a deposit to CrossRef in order for each published article to have a Digital Object Identifier (DOI); to manage the various costs associated with handling and editing submitted manuscripts; and journal management and publication in general.

Each accepted paper (written by two or more authors) is charged USD 295 to help pay for some of the publication costs. This fee covers the first 8 pages. Any published manuscript with more than 8 pages will cost an extra USD 50 per page. You can't have just one author. If the author is the only author, the publication fee is USD 450 for the first 8 pages, which is twice the normal fee. Any published manuscript that is longer than 8 pages will cost an extra USD 100 per page. For Indonesian authors, please refer to [xe.com](https://www.xe.com) for the USD to IDR currency conversion.

The payment should be made by bank transfer (T/T):

Bank Account name/Beneficiary (please be exact): TOLE SUTIKNO
Bank Name: Bank Syariah Indonesia (PT Bank Syariah Indonesia Tbk)*
Branch Office: Yogyakarta Kusumanegara
City: Yogyakarta
Country: Indonesia
Bank Account #: 7168633321
SWIFT Code (BIC) / IBAN: BSMDIDJAXXX
*Predecessors: Bank Syariah Mandiri (PT Bank Syariah Mandiri Tbk)
see: https://en.wikipedia.org/wiki/Bank_Syariah_Indonesia

or as alternative, you can pay by using PayPal to email: INFO@IAESJOURNAL.com

Bank's detailed address:

Bank Syariah Indonesia (BSI)
[Jl. Kusumanegara No.112, Muja Muju, Kec. Umbulharjo](#)
City: Yogyakarta
Province: D.I. Yogyakarta
Country : Indonesia
Post Code: 55165
Indonesia, Phone:+62 274 417222

The Beneficiary's address:

D2, [Griya Ngoto Asri, RT 06, Bangunharjo, Sewon](#)
City: Bantul
Province: D.I. Yogyakarta (DIY)
Post Code: 55187
Country: Indonesia

On Thu, Dec 14, 2023 at 9:36 AM Amar Vijai Nasrulloh <amarvijai01@ulm.ac.id> wrote:

Dear Assoc. Prof. Dr. Selvakumar Manickam
Editor-in-Chief, IJRES

Many thanks for the acceptance confirmation in the IJRES Journal.
Hereby attached our final version of the paper and its similarity index.
Once it is confirmed, please kindly send us the invoice of the manuscript publication.

Thank you for your consideration.

Amar V Nasrulloh

21040-40128-1-RV-OK (1)

by Prodi Fisika FMIPA ULM

Submission date: 13-Dec-2023 09:43AM (UTC+0700)

Submission ID: 2194403739

File name: 21040-40128-1-RV-OK_1.docx (1.67M)

Word count: 6343

Character count: 32654



Design of IoT-based Monitoring System for Temperature and Dissolved Oxygen Levels in Catfish Aquaculture Pond Water

Nurma Sari¹, Yuniar Savitri¹, Sri Cahyo Wahyono¹, Joko Santoso¹, Amar Vijai Nasrulloh¹

¹Physics Study Program, University of Lambung Mangkurat, Indonesia

Article Info

Article history:

Received month dd, yyyy

Revised month dd, yyyy

Accepted month dd, yyyy

Keywords:

Catfish aquaculture pond

IoT-based

Dissolved oxygen levels

Temperature

Nodemcu esp8266

ABSTRACT

One of the fish in Indonesian waters that has been successfully bred and cultivated is the catfish (*Pangasius sp.*). In catfish farming, there are several water quality factors that need to be considered, such as temperature and dissolved oxygen levels. Erratic weather patterns cause poor water quality for fish farming, which makes fish susceptible to disease and if it continues will result in mass fish mortality. Based on the existing description, it is very important to pay attention to the water quality of aquaculture ponds, especially temperature and dissolved oxygen levels for fish survival. This study aims to create an internet of things based (IoT-based) monitoring system for temperature and dissolved oxygen levels in catfish aquaculture pond water based on NodeMCU ESP8266. Monitoring system is using SEN0237 gravity analog dissolved oxygen sensor, DS18B20 sensor module, NodeMCU ESP8266, 20x4 character LCD, Micro SD card module, internet modem. Data from measurements of temperature and dissolved oxygen levels are stored online in the Adafruit.io database in the .csv format and on a micro SD card in the device in the .txt format. The effective value of the probe filling solution on the SEN0237 analog dissolved oxygen sensor is around 3-4 hours. During the 3 days measurement, the lowest value of dissolved oxygen levels and temperature are 3,4 mg/L or 3.4 ppm and a temperature of 27,9°C, respectively. Meanwhile, the highest value of dissolved oxygen levels and temperature are 4,6 mg/L or 4,6 ppm and temperature of 30,9°C, respectively.

This is an open access article under the CC BY-SA license.



Corresponding Author:

Nurma Sari

Physics Study Program, University of Lambung Mangkurat

70714, Banjarbaru, Indonesia

Email: nurmasari01@ulm.ac.id

1. INTRODUCTION

Catfish is one of the native fish in Indonesian waters that grows well. Catfish is a freshwater fish that belongs to the catfish (*Pangasius sp.*) type. Pangasidae can be mass-produced and offers the potential for industrial-scale development due to its basic characteristics of lacking scales, having few spines, having a fairly fast growth rate, and having high fertility and survival rates. With all these benefits, this fish has increased economic value among fishery commodities, both in the hatchery and grow-out business sectors [1], [2]. In recent times, real time water quality monitoring in aquaculture has been brought by the fast development of Internet of Things (IoT) technology effectively. Globally, water quality monitoring systems based on IoT and wireless communication technologies have been widely studied intensively [3], [4], [5], [6], [7], [8], [9], [10], [11], [12], [13].

Dissolved oxygen levels are one of the water quality parameters that can cause large numbers of fish to die. The processes of decomposition, reproduction and development in ponds are hampered by low dissolved oxygen levels. According to Indonesian National Standard (SNI 01-6483.3-2000) for catfish culture, dissolved oxygen levels range from >4 mg/L. The need for fish for dissolved oxygen levels depends on the age of the fish, fish activity, and water quality [14]. Dissolved oxygen levels in ponds vary from time to time. [15]

research show that dissolved oxygen levels change due to the influence of changing temperatures due to unstable weather. According to [16], dissolved oxygen levels for fisheries must be at least 5 mg/L. If the concentration of dissolved oxygen is not balanced, the fish will be stressed because the brain does not get enough oxygen. Fish will experience anoxia because their body tissues are unable to bind dissolved oxygen in the blood.

The water temperature of fish farming ponds is an important factor. The ideal temperature tolerance range for catfish according to SNI 01-6483.3-2000 is between 25-30°C. Pool water temperature affects water quality [17]. Oxygen solubility is one of the characteristics of water quality that is affected by temperature variations. With increasing temperature, the level of solubility of oxygen decreases [18]; [19]. Once there is an increase in temperature, the amount of solubility of oxygen in water will decrease. An increase in temperature causes the metabolic activity of fish to be greater which results in a doubling of oxygen consumption in fish. Low water temperature can affect the ability of fish to bind oxygen so that it can inhibit fish development [20]. Fish that experience stress reduce stamina and reduce hunger, and eventually starve to death [16].

The DS18B20 temperature sensor is a device that can read temperature variations and then translate these changes into electrical quantities. This sensor is connected to the microcontroller using a single cable and is a digital sensor. These sensors are special because each sensor contains a serial code that allows the use of multiple DS18B20s in one-wire transmission. This sensor can be used with 3.0V to 5.5V. The sensor has $\pm 0.5^\circ\text{C}$ accuracy from -10°C to $+85^\circ\text{C}$ and can be used in the temperature range of -55 to 125°C (-67°F to $+257^\circ\text{F}$) with a resolution of 9 to 12 bits. [21]. SEN0237 gravity analog dissolved oxygen sensor is a sensor for measuring dissolved oxygen levels in water. These sensors are widely used in various water-related sectors, including research, aquaculture, and monitoring of the aquatic environment. This sensor is open source and compatible with various microcontrollers, allowing users to use it freely and openly. This sensor has a galvanic probe type with a detection range of 0 - 20 mg/L. This sensor has a response time of up to 98% full response, within 90 seconds (25°C) sensor pressure range from 0 ~ 50PSI with electrode service life generally for 1 year for normal use [22]. NodeMCU ESP8266 is a microcontroller equipped with the ESP8266 chip. This microcontroller has multiple input or output ports to enable monitoring and control applications for IoT projects. The NodeMCU ESP8266 is an evolution of the ESP8266 version of the ESP-12 IoT (Internet of Things) platform module family. This module works very similarly to the Arduino module platform in terms of functionality, but the difference is "Connected to the Internet" [23].

Several studies that have been conducted regarding the measurement of water quality in aquaculture ponds. For instance, Mardhiya in 2017 was working on a data acquisition system for measuring dissolved oxygen levels with the results that the average DO level is in the range of 3 to 5 mg/L in rainy conditions and between 3 to 7 mg/L on cloudy conditions [24]. Next, research by Sumardiono, *et al.* in 2020, was showing a system for monitoring temperature and dissolved oxygen levels in catfish ponds with the Raspberry Pi that was obtained the water temperature varied with time [25]. Furthermore, research by Suriana, *et al.* in 2021 built a temperature remote monitoring system in Bangkok tilapia ponds, the effective temperature for fish pond water was an indicator of 28°C to 30°C [26]. To fill the needs of fish consumes, aquaculture methods have been forced to overproduce and resulting in the accelerated water environment degradation and the old of agricultural workers in many parts of the world so will face the dilemma of shortage of labor, and IoT aquaculture method is one of the method that can resolve the issue [27]. Fish farming has been applied widely recently. In Bangladesh, fish monitoring had been studied based on IoT so it notified the user the amount of dissolved oxygen, ammonia level, pH level, and water body temperature. It can help fish farmers to measure the parameters and provide necessary things to grow more fish and facing water pollution [28]. Latest research by Loh, *et al.* [29] showed that to address the challenges of maintaining aquatic environment, IoT Fish Farm Monitoring System has been done to provide several features such as temperature, pH, Dissolved Oxygen (DO), total dissolved solid, and energy usage of the water pump.

Erratic weather patterns cause poor water quality for fish farming, which makes fish susceptible to disease and if it continues will result in mass fish mortality. Based on the existing description, it is very important to pay attention to the water quality of aquaculture ponds, especially temperature and dissolved oxygen levels for fish survival. In this research, a remote and Internet of Things (IoT) based monitoring system for temperature and dissolved oxygen levels in catfish farming ponds will be made using the DS18B20 and SEN0237 Gravity analog dissolved oxygen sensor internet-based sensors which will be tested and implemented in catfish farming ponds. This monitoring system uses NodeMCU ESP8266 as a microcontroller and Adafruit.io as an online interface. By applying IoT technology with an internet network, this up-to-date technology is able to send data and offer speed and a vast distance [30]. This research develops IoT technology for sending parameter data from DO level and temperature directly to a web server. Then, the stored data for 24 hours on the webserver can be processed for further identification all the time.

2. RESEARCH METHOD

2.1 Material

The materials used are the sensor modules which are DS18B20 temperature sensor and SEN0237 gravity analog dissolved oxygen sensor. Next is the microcontroller kit that consists of NodeMCU ESP8266, 20x4 character LCD with I2C and SD card module. It is also supported by 12V 2A adapter, step down DC to DC converter, tin, electronic components, connecting cables and control panel box.

2.2 Method

2.2.a Hardware

The proposed of the NodeMCU ESP8266-based IoT monitoring system for temperature and dissolved oxygen consists of several stages starting with preparing the tools and materials needed in this research (Figure 1). It proceeds with assembling the hardware, namely integrating the NodeMCU ESP8266 with the sensor, and assembling a remote monitoring system for temperature and dissolved oxygen based on the NodeMCU ESP8266. Furthermore, the manufacture of software includes the manufacture of microcontroller software, manufacture of LCD interface software and manufacture of IOT software. Followed by determining the transfer function of measuring instruments, testing the system as a whole and finally data collection. The details of the proposed system can be seen clearly in Figure 1a. Meanwhile, Figure 1b shows layout of the circuit design of remote monitoring of temperature and dissolved oxygen levels based on Node MCU ESP8266. It is included SEN0237 analogue dissolved oxygen sensor, DS18B20 sensor, SD Card module and 20 x 4 characters I2C LCD module are integrated into the NodeMCU ESP8266.

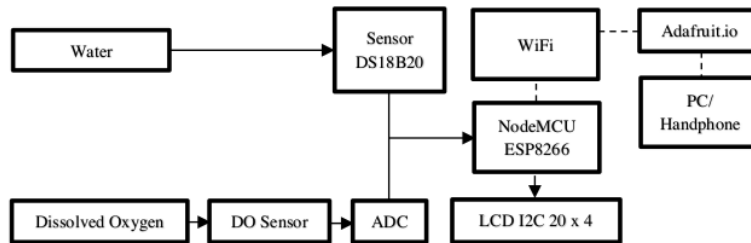

(a)

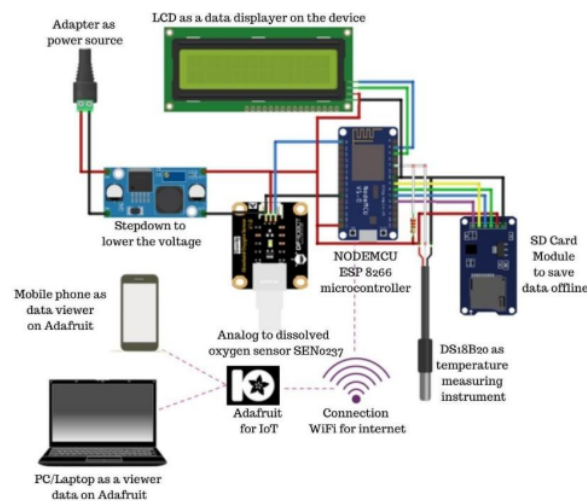

(b)

Figure 1. Proposed system, (a) Block diagram, (b) Circuit design

2.2.b Software

Figure 2 shows the function of NodeMCU ESP8266 for both with sensors and LCD and also with IoT. The software on NodeMCU ESP8266 is made using the Arduino IDE software. The software Interface to LCD using Arduino IDE software that connecting between NodeMCU ESP8266 and sensors (DS18B20 dan SEN0237 analog dissolved oxygen sensor). The stages include LCD pin configuration, library input, and giving commands to retrieve data from the output of the measuring instrument circuit. The flowchart of the programme interface to display characters on the LCD can be seen in Figure 2a.

Calibration was accomplished by comparing the measured value on the sensor with the measured value on a standard measuring instrument. For the DS18B20 sensor, a digital thermometer is used as a comparison. The measurement range used is 10°C to 50°C. Meanwhile, for the SEN0237 grativity analog dissolved oxygen sensor, a DO meter is used as a comparison. Measurements were made using zero dissolved oxygen powder which was added little by little until a measured DO value of 0 mg/L was obtained.

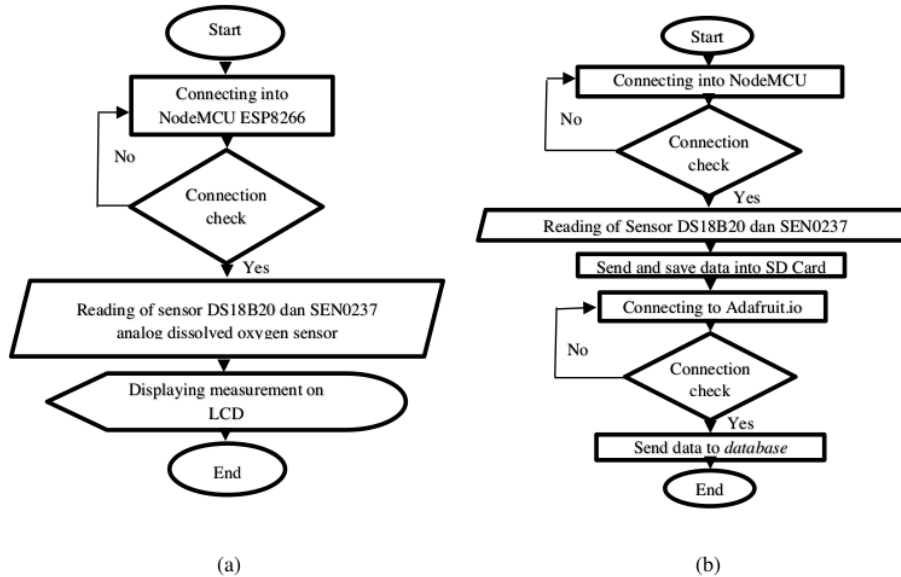

Figure 2. Flowchart of (a) NodeMCU ESP8266 with sensors and LCD, and (b) NodeMCU ESP8266 with IoT

Figure 2b presents connection of NodeMCU ESP8266 with IoT. The system developed by the Arduino IDE software and the IoT interface used Adafruit.io. In details, to connect NodeMCU ESP8266 with IoT, it is mandatory to write down the wifi name and password of the wifi used. To link readings to Adafruit.io, the listing should include the Adafruit.io web address, the username of the Adafruit.io account used, the active key, and the name of the feed used. The monitoring system that is made is tested first by observing each part whether it is working properly. Next, a performance check of the NodeMCU ESP8266 is carried out by connecting to the internet so that it reads Adafruit.io. After connected to the internet and a notification appears that Adafruit.io has been connected, a comparing the values between on the LCD of the device and Adafruit.io. Once the reading value of the measuring instrument that appears is appropriate, the tool can be used.

Calibration was accomplished by comparing the measured value on the sensor with the measured value on a standard measuring instrument. For the DS18B20 sensor, a digital thermometer is used as a comparison. The measurement range used is 10°C to 50°C with the sensor readings obtained, the following equation (1) is obtained:

$$y = 1,0129x + 0,2557 \text{ with } R^2 = 1 \quad (1)$$

Equation (1) is then entered into the Arduino program. It is intended that the readings from the DS18B20 sensor are the same as standard measuring instruments. After the equation is entered into the Arduino program, retesting is carried out with a temperature range of 20 °C to 35 °C as a representative of the reasonable limit for measuring catfish pond water. Data on the results of retesting the DS18B20 sensor can be seen in Table 1. Meanwhile, for the SEN0237 grativity analog dissolved oxygen sensor, a DO meter is used as a comparison. Measurements were made using zero dissolved oxygen powder which was added little by little until a measured DO value of 0 mg/L was obtained. Based on the sensor readings obtained, the following equation (2) is obtained:

$$y = 126,22x - 129,85 \text{ with } R^2 = 0,9664 \quad (2)$$

Equation (2) is then entered into the Arduino program. This aims to convert the reading from SEN0237 analog dissolved oxygen sensor into mg/L like the reading from DO meter. After the equation is entered into the Arduino program, a retest is carried out using PDAM water with calibration powder added

little by little until the dissolved oxygen level in PDAM water becomes zero mg/L. The data of SEN0237 analog dissolved oxygen sensor retest can be seen in Table 2.

Table 1. DS18B20 Sensor Retest Result Data

No	Calibrator (\bar{x})	DS18B20 Sensor (\bar{x}_i)	Difference ($\bar{x}-\bar{x}_i$)	Error (%)
1	20	20	0	0.00
2	21	21.02	-0.02	0.10
3	22	22.03	-0.03	0.14
4	23	23.04	-0.04	0.17
5	24	23.99	0.01	0.04
6	25	25	0	0.00
7	26	26.02	-0.02	0.08
8	27	27.03	-0.03	0.11
9	28	28.04	-0.04	0.14
10	29	28.99	0.01	0.03
11	30	30.01	-0.01	0.03
12	31	31.02	-0.02	0.06
13	32	32.03	-0.03	0.09
14	33	33.04	-0.04	0.12
15	34	34.06	-0.06	0.18
16	35	35.01	-0.01	0.03
Error Mean				0.1

Table 2. Result of the retest Data on SEN0237 analog dissolved oxygen sensor

No	Calibrator (\bar{x})	SEN0237 Sensor (\bar{x}_i)	Difference ($\bar{x}-\bar{x}_i$)	Error (%)
1	6.50	6.82	-0.32	4.92
2	6.03	6.57	-0.54	8.9
3	5.90	6.07	-0.17	2.82
4	5.70	5.58	0.12	2.05
5	5.27	5.18	0.09	1.71
6	4.53	4.35	0.18	4.12
7	3.80	3.09	0.71	18.77
8	2.53	1.75	0.78	31.05
Error Mean				9.3

2.2.c System Realization

Figures 3 show the location and configuration of the equipment and its placement in the catfish farming pond. Pre-data collection was retrieved for 2 days to determine the readiness of the tool before the actual data collection was carried out. Pre-data collection was carried out during weather conditions after rain and in ponds with cloudy weather conditions accompanied by rain. Data monitoring can be monitored via mobile phones and laptops or other devices that can access the internet. To monitor the measurement results via the internet, users can open the link that has been provided for this monitoring system. Measurements will begin when the NodeMCU ESP8266 microcontroller is connected to the internet. The process of connecting the microcontroller to the internet takes ± 40 seconds depending on the speed of internet access. The better the internet network used, the faster the microcontroller is connected. If the internet network is disconnected, the data displayed is the last data before the network is disconnected. This monitoring system has a weakness in the DO sensor used, which is a probe filling solution sensor that must always be monitored. During the pre-

take, it is known that the effective use of the probe filling solution is about 3-4 hours. Therefore, every 3-4 hours it is necessary to check and replace the probe filling solution so that the measurement results obtained have a good value. The probe filling solution used should always be in good condition and no bubbles should form on the filling membrane. The formation of bubbles and poor probe filling solution can affect the measurement results.

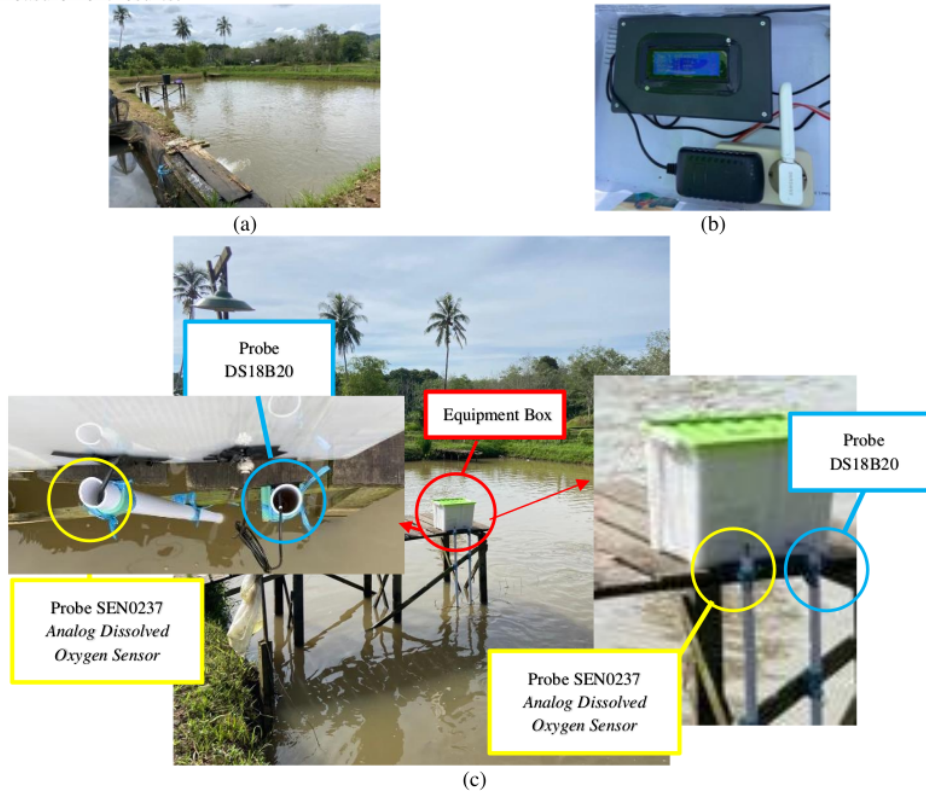

Figure 3. (a) Location of catfish ponds where data is collected, and (b) Measurement and IoT system processing equipment, and (c) IoT based monitoring system for temperature and dissolved oxygen levels in catfish farming ponds

Location of the ponds in this research can be clearly seen in Figure 3a. The laying tools in the field using a box that is given a hole and then associated with a paralon pipe tied to the bridge. The tool box, modem and power outlet (Figure 3b) are placed in a green box which is then given a hole for the sensor probe. The sensor probe is connected to the outside of the box and then inserted into the paralon pipe that has been tied to the bridge to prevent the position of the probe from moving if it is hit by a fish that has an impact on the measurement (Figure 3c).

3. RESULTS AND DISCUSSION

The calibration process of the SEN0237 analog dissolved oxygen sensor. Measurements were carried out three times using water mixed with zero dissolved oxygen powder until the dissolved oxygen level in the water was zero mg/L. Based on the results of the sensor readings obtained the regression formula (Equation 2) and adapted into Arduino program. From the results of retesting conducted, it is known that the average error in sensor readings is 9.3% (Table 2). Meanwhile, based on the results of the DS18B20 temperature sensor during calibration, it is obtained the regression formula in Equation 1. This equation is then adapted into the Arduino program. It is intended that the readings from the DS18B20 sensor are the same as standard measuring instruments. From the results of retesting, it is known that the average error value of reading is 0.1% (Table 1).

The readings that appear on the Adafruit IO dashboard are temperature, dissolved oxygen (mg/L), and dissolved oxygen (ppm) in the form of images and gauges. Figure 4 is the interface display on Adafruit IO. The gauge is given a limit value, where if the dissolved oxygen value is below 4 mg/L or 4 ppm and the

temperature is below 25 °C and more than 30 °C then the gauge will turn red as a sign that the measurement was carried out in a condition that is not in accordance with SNI 01- 6483.3-2000. Meanwhile, when the measurement results are >4 mg/L or 4 ppm for dissolved oxygen and the temperature is around 25-30°C, the gauge will turn green. Data display indicators for monitoring can be said to be real-time if the interface for sensor readings that appear on the LCD and the Adafruit.io dashboard is "same". Figure 5 shows the real-time readings of the Adafruit.io LCD and dashboard.



Figure 4. Adafruit.io display developed

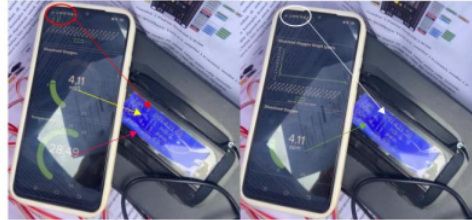

Figure 5. Testing and validating of the IoT-based system

Data measurement from the downloaded of Adafruit.io database is in CSV file format, while stored on the micro SD card is in The TXT file format (Figure 6). Data stored in the Adafruit.io database can be downloaded in CSV (Comma Separated Value) file format for each feed (Figure 6a). Along side stored online in the Adafruit.io database, measurement data is also stored offline on a micro SD card in the form of a TXT file. The stored data contains time data, SEN0237 analog dissolved oxygen sensor readings in mg/L and ppm units, as well as DS18B20 sensor module readings which are separated by commas “,”. This data can be converted into a spreadsheet table for comparative image analysis. Figure 6b shows the TXT file data written to and stored on the micro SD card.

A1									
	A	B	C	D	E	F	G	H	
1	id,value,feed_id,created_at,lat,lon,ele								
2	0f82MYT83POV2GJ9WVNSPjRBTG,1.03,2490571,2023-03-30 05:29:32 UTC...								
3	0f82MYX9RQ7JRUSD2819HWBP4,1.03,2490571,2023-03-30 05:29:42 UTC...								
4	0f82MZD07XFMCCG5GZ2G1X1,1.03,2490571,2023-03-30 05:29:52 UTC...								
5	0f82MZ39WGU1VYKREDSHFVRL,1.03,2490571,2023-03-30 05:30:02 UTC...								
6	0f82MZ6SKRCQ8981KCCO49K,1.03,2490571,2023-03-30 05:30:13 UTC...								
7	0f82MZNMW8M9TEV59YICVQGG8H,1.03,2490571,2023-03-30 05:30:23 UTC...								
8	0f82MZCQTHNW30T3QVFWFZC2,1.03,2490571,2023-03-30 05:30:33 UTC...								
9	0f82MZFT28NG7W7QBVM5C29GG8,1.03,2490571,2023-03-30 05:30:43 UTC...								
10	0f82MZVW5G776YGHUZQVZ1G,1.03,2490571,2023-03-30 05:30:53 UTC...								
11	0f82MZQ71KRZTF58KN89G3D9,1.03,2490571,2023-03-30 05:31:07 UTC...								
12	0f82MZ959W112N764J7NCL15H,1.03,2490571,2023-03-30 05:31:14 UTC...								
13	0f82MZV8XFC851284HKCCXAK39,1.03,2490571,2023-03-30 05:31:24 UTC...								
14	0f82MZCZRTJ0T7X7QA226AG5A,1.03,2490571,2023-03-30 05:31:34 UTC...								
15	0f82N02GQNGGIZVF9NTY89182,1.03,2490571,2023-03-30 05:31:44 UTC...								
16	0f82N05KEF90CZMPAM4N9GH38R0,1.03,2490571,2023-03-30 05:31:54 UTC...								
17	0f82N06R8X6VP13WHDAMQK8E,1.03,2490571,2023-03-30 05:32:05 UTC...								
18	0f82N0BV4N67691EXCR2PVLMSA,1.03,2490571,2023-03-30 05:32:15 UTC...								
19	0f82N0E8F5128K8P2KMS0YN8Y9,1.03,2490571,2023-03-30 05:32:25 UTC...								
20	0f82N0D7FES15CS87WVZJHC,1.03,2490571,2023-03-30 05:32:35 UTC...								
21	0f82N0N419V9GQ2N1142YCTUT,1.03,2490571,2023-03-30 05:32:45 UTC...								

(a)

File	Edit	View
Maktu,Dissoolved Oxygen (mg/L),Maktu,Dissoolved Oxygen (ppm)		
07:27:19,2.55,2.55,26.91		
07:27:30,2.50,2.50,27.73		
07:27:40,2.55,2.55,27.67		
07:27:50,2.47,2.48,27.67		
07:28:00,2.52,2.52,27.67		
07:28:10,27.37,27.40,27.67		
07:28:21,8.79,8.80,27.60		
07:28:31,7.84,7.85,27.54		
07:28:41,7.48,7.49,27.35		
07:28:51,7.48,7.49,27.16		
07:29:01,7.05,7.05,27.35		
07:29:12,4.95,4.96,27.22		
07:29:22,3.96,3.96,27.79		
07:29:32,3.50,3.50,27.79		
07:29:42,3.52,3.52,27.86		
07:29:52,3.39,3.40,-128.38		
07:30:03,3.39,3.40,27.86		
07:32:53,3.50,3.50,27.86		
07:34:34,3.27,3.27,27.86		
07:34:44,3.34,3.34,27.86		
07:37:06,3.29,3.29,27.86		

(b)

Figure 6. Display of measurement results data of (a) The downloaded from the Adafruit.io database in CSV file format, and (b) The TXT file data written to and stored on the micro SD card

Data collection was retrieved for three days (Figure 7). The measuring instrument is placed on a bridge with a height of ±80 cm from the water surface with the sensor probe submerged about 2-4 cm from the water surface. During data collection, the weather is constantly changing. Data collection on first day was in cloudy weather conditions accompanied by rain during the day. The relationship between temperature and dissolved oxygen levels from data collection on the first day can be seen in Figure 7a. From the figure it is known that when the temperature increases the dissolved oxygen levels decrease and vice versa. From the figure 7a, the relationship between temperature and dissolved oxygen levels is most clearly seen at point a at 13.15, where the DO value reaches 4.5 mg/L or 4.5 ppm with a measured temperature of 28.6°C. it also shows a decrease in DO values and temperature due to rain during the day, from 13.15 to 14.30. Apart from when it rains, DO values and measured temperatures also tend to decrease at night at 19.15. The DO value measured after rain and at night fell below 4 mg/L.

Data collection on second day was cloudy in the morning, then hot during the day and cloudy again in the late afternoon. Figure 7b is a graph of the relationship between temperature and dissolved oxygen levels. From the figure it is known that when the temperature increases the dissolved oxygen level decreases and vice versa as seen at 19.30 to 20.00. In some conditions there are temperature values that are not in accordance with the theory, such as at points d to e where the temperature values measured exceed the value of 30°C at 13.00

Paper's should be the fewest possible that accurately describe ... (First Author)

to 17.30 caused by the hot sun during the day. The DO value between 10.00 and 11.30 is measured to be less than 4 mg/L in the morning with cloudy weather conditions after rain. The low DO value measured is the DO value measured at the time of changing the probe filling solution because when changing the probe is removed from the water. The low DO measured, aside from the effect of temperature, is also caused by other factors such as the water level and the water content.

Data collection on third day in sunny weather conditions in the morning then hot during the day, cloudy in the late afternoon accompanied by rain at night. Figure 7c is a graph of the relationship between temperature and dissolved oxygen levels. The figure during the temperature increases the dissolved oxygen levels decrease and vice versa. The relationship between temperature and dissolved oxygen can be seen at 15.45 to 17.15 once DO increases the temperature value decreases. In some conditions there are temperature values measured outside the limits of SNI provisions at 11.30 to 16.30 with the measured values are more than 30°C. This condition occurs due to the hot weather during the day that causes the temperature to increase. DO values that were measured outside the regulatory limits were seen between 10.00 and 10.45 and at 17.15 to 20.00, where DO values were measured below 4 mg/L. The low DO measured apart from temperature is also caused by other factors such as water level and water content. From the data image, the most obvious one is at 14.00 where the DO value reaches 4.2 mg/L or 4.2 ppm with a measured temperature of 30.9°C.

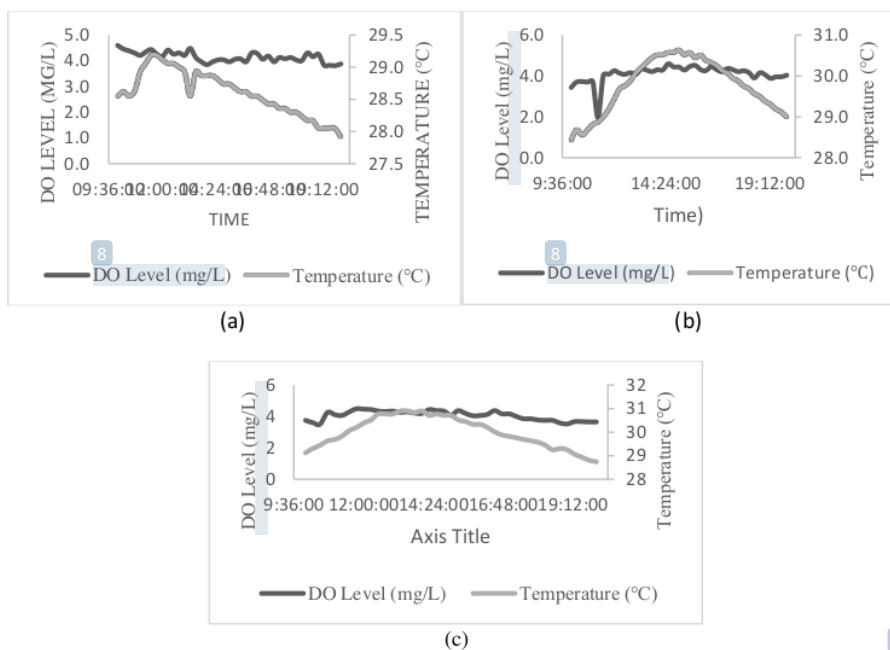

Figure 7. Data collection of DO Level (black line) and Temperature (gray line) for three days, (a) First day data collection, (b) Second day data collection, and (c) (a) Third day data collection, 23

Based on measurements carried out for three days, from 10.00 to 20.00 (Table 3), it is known that the temperature and DO values of the Karang Intan catfish pond are relatively safe and quite good. In the morning DO in fish pond water is quite low, then it increases as the day progresses. When it rains, the measured DO levels also decrease. This is similar to research conducted by Mardhiyana (2017) which obtained an average DO level in the range of 3 to 5 mg/L in rainy conditions and a range of 3 to 7 mg/L in cloudy conditions. Abundant oxygen levels during the day with sunny weather due to the process of respiration by macrophytes in the mechanism of photosynthesis with the help of sunlight. While at night DO decreased again. The decrease in dissolved oxygen levels at night is due to the absence of photosynthesis at night, also caused by the level of temperature fluctuations by the air, the increased respiration rate of sediment by bacteria and the more intense respiration rate in fish ponds by aquatic organisms. As for the temperature, it is influenced by the surrounding conditions. As the day gets darker, when the weather is cloudy and it rains, the measured temperature decreases and vice versa, when the weather is sunny and the sun is hot enough, the measured temperature increases. This is similar to research conducted by Sumardiono (2020), for example when it is sunny the temperature will rise to around 29°C, when it is foggy it will drop to around 27.7°C, and at night it will generally drop to around

29.4°C. The graph of the maximum and minimum values of DO and temperature measured for 3 days can be seen in Figure 8.

Table 3. Maximum and Minimum Values of Data for Three Days of Measurement

Day	DO (mg/L)				Temperature (°C)			
	Time	Max	Time	Min	Time	Max	Time	Min
1	10:00:01	4.6	19:45:01	3.81	11:45:09	29.19	20:00:37	27.92
2	14:30:15	4.6	10:00:42	3.44	15:00:09	30.64	10:00:42	28.43
3	11:45:20	4.49	10:30:05	3.5	13:30:38	30.9	20:00:12	28.74

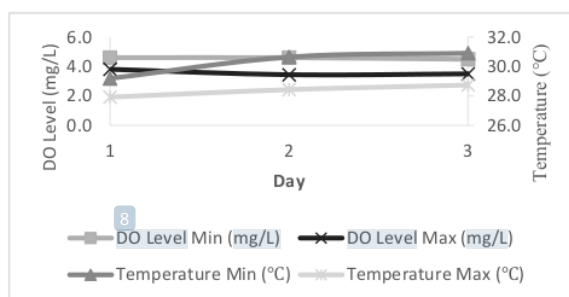

Figure 8. The maximum and minimum values of DO Level and temperature of 3 days of measurement

In Figure 8 it can be seen that DO tends to be lower in the morning, then increases as the day progresses. During 3 days the measurement was carried out, the dissolved oxygen levels and temperature measured during the measurement had the lowest value of 3.44 mg/L or 3.44 ppm with a temperature of 27.92°C and the highest value of 4.6 mg/L or 4.6 ppm with a temperature of 30.9°C. From the measurements taken, it is known that dissolved oxygen levels have good values during the daytime, while in the morning and night have poor values. The maximum value of DO that was measured was obtained at 10.00, 14.30 and 11.45. At night DO tends to decrease, where from the data obtained it is recorded that the minimum DO value is at 19.45, 10.00 and 10.30. Meanwhile, the temperature tends to increase during the day and decreases in the afternoon until the evening. From the data recorded from measurements for three days, it was found that the temperature experienced a maximum value at 11.45, 15.00 and 13.30. The minimum temperature recorded is at 20.00 and 10.00. The low temperature measured in the morning is caused by temperature changes that occur at night accompanied by rain, so that when measurements are taken in the morning the measured temperature tends to be low. From the measurement data obtained, it is known that dissolved oxygen levels are indeed affected by temperature, but this factor does not have a significant effect. There are other factors that affect dissolved oxygen levels in fish pond water. Even so, the water quality measured in the catfish pond is fairly good because the DO and measured temperatures are still within safe limits. The circulation of fish pond water is quite good so that even though the measured DO was below the SNI 01-6483.3-2000 standard for catfish cultivation, DO can again increase to the threshold according to SNI 01-6483.3-2000.

This system also spent a low cost for its operation. In details, for the distilled water solution as a neutralizer or rinsing probes before and after use, approximately 500ml of distilled water is enough for one week of data collection. As for probe filling or NaOH liquid, approximately 30 ml is enough for one week of data collection. Cost calculation for 1 week, 500 ml of distilled water costs USD 0.45 and 30 ml of 0.5 molar NaOH costs USD 0.032 so the total cost for 1 week is USD 0.48. (USD 1 = IDR 15719).

4. CONCLUSION

An IoT-based monitoring system for temperature and dissolved oxygen levels in catfish farming ponds using the DS18B20 and an internet-based DO sensor has been successfully developed. This monitoring system are able to measure temperature and dissolved oxygen levels which have a reading error value for the DS18B20 sensor of 0.1% and for the SEN0237 analog dissolved oxygen sensor 9.3%. The effective value of the probe filling solution on the SEN0237 analog dissolved oxygen sensor is around 3-4 hours. A water quality monitoring system has been implemented in catfish pond in Karang Intan for 3 days starting from 10.00 to 20.00. From the measurements that have been made, it is obtained that the dissolved oxygen level and temperature measured during the measurement have the lowest value of 3.4 mg/L or 3.4 ppm with a temperature of 27.9 °C and the highest value of 4.6 mg/L or 4,6 ppm with a temperature of 30.9°C. The main limitation of the DO sensor is the effective use of the probe filling solution is about 3-4 hours. Therefore, every 3-4 hours it is necessary to check and replace the probe filling solution. In the future, DO sensor replacement

with longer lifetime of used for the probe filling solution replacement. This future research also using photovoltaic cells as independent energy to supply to system so it can be implemented into remote ponds that are unavailable electricity source.

REFERENCES

- [1] Idawati, N. Defira, and S. Mellisa, 'The Effect of Different Life Feed on Growth and Survival of Eatfish Fry (*Pangasius sp.*)', *J. Ilm. Mhs. Kelaut. dan Perikan. Unsyiah*, vol. 3, no. 1, pp. 14–22, 2018.
- [2] Y. Sukrismon, Aripriharta, N. Hidayatullah, N. Mufti, A. N. Handayani, and G. J. Horng, 'Smart Fish Pond for Economic Growing in Catfish Farming', in *Proceedings - 2019 International Conference on Computer Science, Information Technology, and Electrical Engineering, ICOMITEE 2019*, 2019, vol. 1, pp. 49–53, doi: 10.1109/ICOMITEE.2019.8921233.
- [3] D. S. Simbeye and S. F. Yang, 'Water Quality Monitoring and Control for Aquaculture Based on Wireless Sensor Networks', *J. Networks*, vol. 9, no. 4, pp. 849–849, 2014.
- [4] L. Xu, N. Wang, Y. Feng, D. Bao, and K. Jorshin, 'Design of Aquaculture System based on Wireless Monitoring and its Testing', *Int. J. Online Eng.*, vol. 10, no. 5, pp. 68–73, 2014.
- [5] L. Hongpin, L. Guanglin, P. Weifeng, S. Jie, and B. Qiuwei, 'Real-time remote monitoring system for aquaculture water quality', *Int. J. Agric. Biol. Eng.*, vol. 8, no. 6, pp. 136–143, 2015, doi: 10.3965/j.ijabe.20150806.1486.
- [6] C. Encinas, E. Ruiz, J. Cortez, and A. Espinoza, 'Design and implementation of a distributed IoT system for the monitoring of water quality in aquaculture', *Wirel. Telecommun. Symp.*, 2017, doi: 10.1109/WTS.2017.7943540.
- [7] M. Zhang, D. Li, L. Wang, D. Ma, and Q. Ding, 'Design and development of water quality monitoring system based on wireless sensor network in aquaculture', *IFIP Adv. Inf. Commun. Technol.*, vol. 347 AICT, no. PART 4, pp. 629–641, 2017, doi: 10.1007/978-3-642-18369-0_76.
- [8] S. Saha, R. H. Rajib, and S. Kabir, 'IoT Based Automated Fish Farm Aquaculture Monitoring System', in *2018 International Conference on Innovations in Science, Engineering and Technology, ICISSET 2018*, 2018, no. August 2019, pp. 201–206, doi: 10.1109/ICISSET.2018.8745543.
- [9] C. Dupont, P. Cousin, and S. Dupont, 'IoT for aquaculture 4.0 smart and easy-to-deploy real-time water monitoring with IoT', IEEE, 2018.
- [10] L. Parra, S. Sendra, L. García, and J. Lloret, 'Design and deployment of low-cost sensors for monitoring the water quality and fish behavior in aquaculture tanks during the feeding process', *Sensors (Switzerland)*, vol. 18, no. 3, pp. 1–23, 2018, doi: 10.3390/s18030750.
- [11] M. Li, C. Lin, J. Ren, and F. Jiang, 'A Wireless Ecological Aquaculture Water Quality Monitoring System Based on LoRa Technology', in *Advances in Computer Science Research, International Conference on Wireless Communication, Network and Multimedia Engineering (WCNME 2019)*, 2019, vol. 89, pp. 5–7, doi: 10.2991/wcnme-19.2019.2.
- [12] F. A. Saparudin, T. C. Chee, A. S. Ab Ghafar, H. A. Majid, and N. Katiran, 'Wireless water quality monitoring system for high density aquaculture application', *Indones. J. Electr. Eng. Comput. Sci.*, vol. 13, no. 2, pp. 507–513, 2019.
- [13] L. V. Q. Danh, D. V. M. Dung, T. H. Danh, and N. C. Ngon, 'Design and deployment of an IoT-Based water quality monitoring system for aquaculture in mekong delta', *Int. J. Mech. Eng. Robot. Res.*, vol. 9, no. 8, pp. 1170–1175, 2020, doi: 10.18178/ijmerr.9.8.1170-1175.
- [14] Y. Fujaya, *Fisiologi Ikan: Dasar Pengembangan Teknologi Perikanan*, no. 1. Rineka Cipta. Jakarta, 2004.
- [15] W. H. Siegers, Y. Prayitno, and A. Sari, 'Pengaruh Kualitas Air Terhadap Pertumbuhan Ikan Nila Nirwana (*Oreochromis Sp.*) Pada Tambak Payau', *J. Fish. Dev.*, vol. 3, no. 11, pp. 95–104, 2019.
- [16] H. Effendi, *Telaah Kualitas Air Bagi Pengelolaan Sumber Daya dan Lingkungan Perairan*. Yogyakarta: Kanisius, 2003.
- [17] J. S. Lucas and P. C. Southgate, *Aquaculture: Farming aquatic animals and plants*. John Wiley & Sons, 2012.
- [18] D. A. Chin, *Water-Quality Engineering in Natural Systems*. 2006.
- [19] R. Parker, 'Review of life cycle assessment research on products derived from fisheries and aquaculture: a report for Seafish as part of the collective action to address greenhouse gas emissions in seafood.', 2012.
- [20] C. E. Boyd and F. Lichtkoppler, *Water Quality Management in Pond Fish Culture International Center for Aquaculture Agricultural Experiment Station*, no. 22. Project: AID/DSAN-G 0039, 1979.
- [21] Datasheet DS18B20, 'Programmable Resolution 1-Wire Digital Thermometer'. p. 1, 2015.

- [22] Dfrobot, 'Gravity : Analog Dissolved Oxygen Sensor SKU : SEN0237', p. 8, 2018.
- [23] B. Satria, 'IoT Monitoring Suhu dan Kelembaban Udara dengan Node MCU ESP8266', *sudo J. Tek. Inform.*, vol. 1, no. 3, pp. 136–144, 2022, doi: 10.56211/sudo.v1i3.95.
- [24] I. R. Mardhiya, 'Sistem Akuisisi Data Pengukuran Kadar Oksigen Terlarut Pada Air Tambak Udang Menggunakan Sensor Dissolve Oxygen (DO)', 2017.
- [25] A. Sumardiono, S. Rahmat, E. Alimudin, and N. A. Ilahi, 'Sistem Kontrol-Monitoring Suhu dan Kadar Oksigen pada Kolam Budidaya Ikan Lele', *JTERA (Jurnal Teknol. Rekayasa)*, vol. 5, no. 2, p. 231, 2020, doi: 10.31544/jtera.v5.i2.2020.231-236.
- [26] Suriana, A. P. Lubis, and E. Rahayu, 'Sistem Monitoring Jarak Jauh Pada Suhu Kolam Ikan Nila Bangkok Memanfaatkan Internet of Things (IoT) Berbasis NODEMCUESP8266', *JUTSI J. Teknol. dan Sist. Inf.*, vol. 1, no. 1, pp. 1–8, 2021, doi: 10.1093/oseo/instance.00196643.
- [27] C. Wang, Z. Li, T. Wang, X. Xu, X. Zhang, and D. Li, 'Intelligent fish farm—the future of aquaculture', *Aquac. Int.*, vol. 29, no. 6, pp. 2681–2711, 2021, doi: 10.1007/s10499-021-00773-8.
- [28] A. T. Tamim, H. Begum, S. A. Shachcho, M. M. Khan, B. Yeboah-Akouwah, M. Masud and J. F. Al-Amri, 'Development of IoT Based Fish Monitoring System for Aquaculture', *Intell. Autom. Soft Comput.*, vol. 32, no. 1, pp. 55–71, 2022, doi: 10.32604/IASC.2022.021559.
- [29] S. H. Loh, P. C. Teh, G. Y. Goay, and J. J. Sim, 'Development of an IoT-based Fish Farm Monitoring System', in *2023 IEEE 13th International Conference on Control System, Computing and Engineering (ICCSCE)*, 2023, pp. 281–286, doi: 10.1109/iccsce58721.2023.10237168.
- [30] A. C. Subrata, T. Sutikno, Sunardi, A. Pamungkas, W. Arsadiando, and A. R. C. Baswara, 'A laboratory scale IoT-based measuring of the solar photovoltaic parameters', *Int. J. Reconfigurable Embed. Syst.*, vol. 11, no. 2, pp. 135–145, 2022, doi: 10.11591/ijres.v11.i2.pp135-145.

BIOGRAPHIES OF AUTHORS

	Nurma Sari    received the Bachelor's degree in Physics (1996) from University of Diponegoro (UNDIP) and a masters degree in Physics (2007) specializing in waveguide antenna from Institut Teknologi Sepuluh Nopember (ITS). She received Doctoral degree in Physics (2022) at Institut Teknologi Sepuluh Nopember (ITS), Indonesia, funded by BUDI-DN LPDP Indonesia. Her interdisciplinary research interests focus on applying Physics, applying electromagnetics, applying optics and waveguide antenna. She can be contacted at email: nurmasari01@ulm.ac.id .
	Yuniar Savitri    was born in Banjarmasin in 2001. Her educational history went to MIN Langkai Palangkaraya, MTsN 1 Model Palangkaraya, MAN Kota Palangkaraya (2019) and completed his studies in the Bachelor's degree in Physics (2023) in the field of Instrumentation at the University of Lambung Mangkurat. His research interests focus on electronics and Instrumentation of Physics. She can be contacted at email: yuniarsavitri147@gmail.com .
	Sri Cahyo Wahyono    received the Bachelor's degree in Physics (1997) from University of Diponegoro (UNDIP) and a masters degree in Physics (2004) specializing in waveguide antenna from Institut Teknologi Sepuluh Nopember (ITS), Indonesia, funded by DIKTI Indonesia. His interdisciplinary research interests focus on applying physics and geophysics. He can be contacted at email: scwahyono@ulm.ac.id
	Joko Santoso    received the Bachelor's degree in Physics (2019) from University of Lambung Mangkurat (ULM). He is currently a technician in instrumentation and computational physics laboratories at University of Lambung Mangkurat, Indonesia. He can be contacted at email: jokosantoso1507@gmail.com .
	Amar Vijai Nasrulloh    received an undergraduate degree in Physics (2004) from Institut Teknologi Sepuluh Nopember (ITS) and a masters degree in Electrical Engineering (2010) specializing in Biomedical Engineering from Institut Teknologi Bandung (ITB) and a PhD degree in Bioimage Informatics from Durham University, UK, funded by LPDP Indonesia. He is currently a lecturer in Physics Study Program at University of Lambung Mangkurat, Indonesia. His interdisciplinary research interests focus on applying physics and image processing methods to biology and medicine. He can be contacted at email: amarvijai01@ulm.ac.id .

Paper's should be the fewest possible that accurately describe ... (First Author)

ORIGINALITY REPORT

13%

SIMILARITY INDEX

9%

INTERNET SOURCES

9%

PUBLICATIONS

4%

STUDENT PAPERS

PRIMARY SOURCES

- 1 Submitted to King Mongkut's University of Technology Thonburi 2%

Student Paper
- 2 jurnal.fmipa.unila.ac.id 1%

Internet Source
- 3 binapatria.id 1%

Internet Source
- 4 Arsyad Cahya Subrata, Tole Sutikno, Sunardi Sunardi, Anggit Pamungkas, Watra Arsadiando, Ahmad Raditya Cahya Baswara. "A laboratory scale IoT-based measuring of the solar photovoltaic parameters", International Journal of Reconfigurable and Embedded Systems (IJRES), 2022 1%

Publication
- 5 Siu Hong Loh, Peh Chiong Teh, Guang Yang Goay, Jia Jia Sim. "Development of an IoT-based Fish Farm Monitoring System", 2023 IEEE 13th International Conference on Control System, Computing and Engineering (ICCSCE), 2023 1%

6	www.animalsciencejournal.usamv.ro Internet Source	1 %
7	Submitted to Far Eastern University Student Paper	<1 %
8	mdpi-res.com Internet Source	<1 %
9	www.ncbi.nlm.nih.gov Internet Source	<1 %
10	Submitted to Universiti Teknikal Malaysia Melaka Student Paper	<1 %
11	www.researchgate.net Internet Source	<1 %
12	jurnal.polban.ac.id Internet Source	<1 %
13	Submitted to Curtin University of Technology Student Paper	<1 %
14	Enggar Patriono, Resti Amalia, Merry Sitia. "Kualitas air kolam budidaya dan kolam terpal untuk pertumbuhan ikan Lele Sangkuriang (<i>Clarias gariepinus</i>) pada kelompok pembudidaya ikan Lele di Kabupaten PALI Sumatera Selatan", Sriwijaya Bioscientia, 2022 Publication	<1 %

- | | | |
|----|----------------------------------------------------------------------------------------------------------------------------------------------------------------------------------------------------------------|------|
| 15 | Submitted to Middle East College of Information Technology
Student Paper | <1 % |
| 16 | Muhammad Izz Hakimi Zaidi Farouk, Zadariana Jamil, Mohd Fuad Abdul Latip. "Towards online surface water quality monitoring technology: A review", Environmental Research, 2023
Publication | <1 % |
| 17 | cors.archive.org
Internet Source | <1 % |
| 18 | www.ijmerr.com
Internet Source | <1 % |
| 19 | Ngoc-Tran Le, Claude Vo, Ngoc Dang Khoa Tran. "Design and implement a monitoring and early warning system of water quality for cage fish culture on Chava river", AIP Publishing, 2021
Publication | <1 % |
| 20 | Lorena Parra, Laura García, Sandra Sendra, Jaime Lloret. "The Use of Sensors for Monitoring the Feeding Process and Adjusting the Feed Supply Velocity in Fish Farms", Journal of Sensors, 2018
Publication | <1 % |
| 21 | Zeenat Shareef, S.R.N. Reddy. "Wireless sensor network for aquaculture: Review, | <1 % |

survey, and case study of aquaculture practices in western Godavari region", Journal of Ambient Intelligence and Smart Environments, 2018

Publication

22

ijece.iaescore.com

Internet Source

<1 %

23

Ritika Verma, K.S. Daya. "Understanding the decay of proteins: A method to study time dependent response of pM concentration of insulin at microwave frequencies", MethodsX, 2017

Publication

<1 %

24

ejournal.radenintan.ac.id

Internet Source

<1 %

25

Ekha Yogafanny, Ardhiva Hayu Octora, Suharwanto. "Community-based spring conservation in Purwoharjo Village, Samigaluh, KulonProgo, Yogyakarta, Indonesia", AIP Publishing, 2020

Publication

<1 %

26

Goib Wiranto, Yudi Yuliyus Maulana, I Dewa Putu Hermida, Iqbal Syamsu, Dadin Mahmudin. "Integrated online water quality monitoring", 2015 International Conference on Smart Sensors and Application (ICSSA), 2015

Publication

<1 %

- 27 Submitted to Halcyon London International School
Student Paper <1 %
-
- 28 Rian Luthfi Fadilah, Sutarman. "Geometry Learning Media Application For Elementary School Students Using Android-Based Augmented Reality Technology", Indonesian Journal of Computer Science, 2023
Publication <1 %
-
- 29 beei.org
Internet Source <1 %
-
- 30 emitter.pens.ac.id
Internet Source <1 %
-
- 31 www.cyberjournals.com
Internet Source <1 %
-
- 32 Gregorius Nugroho Susanto, Supono, Fadhli Dzil Ikrom. "Sex reversal of juvenile freshwater crayfish (Cherax quadricarinatus) influenced by steroid extract of sea cucumber and 17 α -methyltestosterone hormone at different temperatures", AIP Publishing, 2018
Publication <1 %
-
- 33 Guandong Gao, Ke Xiao, Miaomiao Chen. "An intelligent IoT-based control and traceability system to forecast and maintain water quality in freshwater fish farms", Computers and Electronics in Agriculture, 2019 <1 %

34

Krishna Reddy D, S. Siva Priyanka, Aruru Sai Kumar, Jhansi Kunduru, Nandhini Batta. "IoT Based Water Quality Monitoring for Smart Aquaculture", 2023 14th International Conference on Computing Communication and Networking Technologies (ICCCNT), 2023

Publication

<1 %

35

Sophia Laily, Catur Retnaningdyah, Bagyo Yanuwiadi. "The effectiveness of leachate remediation in the implementation of unvegetated constructed wetland", AIP Publishing, 2017

Publication

<1 %

36

d-nb.info
Internet Source

<1 %

37

[ijres.iaescore.com](https://www.ijres.iaescore.com)
Internet Source

<1 %

38

pdfs.semanticscholar.org
Internet Source

<1 %

39

[repository.ipb.ac.id:8080](https://repository.ipb.ac.id/8080)
Internet Source

<1 %

40

talenta.usu.ac.id
Internet Source

<1 %

41

Abu Taher Tamim, Halima Begum, Sumaiya Ashfaque Shachcho, Mohammad

<1 %

Monirujjaman Khan et al. "Development of IoT Based Fish Monitoring System for Aquaculture", Intelligent Automation & Soft Computing, 2022

Publication

Exclude quotes On

Exclude matches Off

Exclude bibliography On

**Fwd: [IJRES] Editor Decision: ACCEPTED - a Scopus indexed journal (SJR Q3)**

1 message

Amar Vijai <amarvijai01@ulm.ac.id>
To: Nurma Sari <nurmasari01@ulm.ac.id>

Mon, Jan 22, 2024 at 10:36 AM

Pembayaran sdh diterima/konfirmasi oleh editor

Amar

Begin forwarded message:

From: IJRES Editor <ijres@iaesjournal.com>
Date: 19 January 2024 23.40.13 GMT+8
To: Amar Vijai Nasrulloh <amarvijai01@ulm.ac.id>
Subject: Re: [IJRES] Editor Decision: ACCEPTED - a Scopus indexed journal (SJR Q3)

Thanks, I have received it.

On Mon, Jan 15, 2024 at 12:51 PM Amar Vijai Nasrulloh <amarvijai01@ulm.ac.id> wrote:
Dear Assoc. Prof. Dr. Selvakumar Manickam,
Editor-in-Chief, IJRES

Many thanks for the acceptance confirmation in the IJRES Journal.
Hereby attached our Payment (USD 445 for 11 pages based on xe.com conversion today), final version of the paper and its similarity index.

Thank you for your consideration.

Amar V Nasrulloh

On Fri, Dec 22, 2023 at 3:17 PM Selvakumar Manickam <ijres@iaesjournal.com> wrote:

--Paper ID # 21040
--We usually want at least 25 references, most of which should be to journal papers (for research papers).
--IJRES Author Guidelines and Template:
<http://www.iaescore.com/gfa/ijres.docx>
--Please send us your similarity report. You can use software like iThenticate or Turnitin to make sure that the result is below 20%. If the similarity index is more than 20%, the paper will not be published when planned or at all.
--Your final paper needs to be turned in within 6 weeks!

Dear Prof/Dr/Mr/Mrs: Amar Vijai Nasrulloh,

Your article titled "Design of IoT-based Monitoring System for Temperature and Dissolved Oxygen Levels in Catfish Aquaculture Pond Water" has been accepted for publication in the International Journal of Reconfigurable and Embedded Systems (IJRES), p-ISSN 2089-4864, e-ISSN 2722-2608, a peer-reviewed and open access journal distributed under the terms and conditions of the Creative Commons Attribution-ShareAlike 4.0 International License, and indexed by Scopus (<https://www.scopus.com/sourceid/21101061447>). This journal has been included in the SCImago Journal Rank (SJR, <https://www.scimagojr.com/journalsearch.php?q=21100901206&tip=sid&clean=0>)

and has an SJR of 0.218 (Q3). Congratulations!

Please submit your final work along with your similarity report and proof of payment to IJRES@IAESJOURNAL.COM within six weeks. Highlight your contribution to the field of reconfigurable systems, embedded systems, VLSI design, or the internet of things (IoT). In your final work, you must strictly adhere to the authors' guide (<http://iaescore.com/gfa/ijres.docx>) and the checklist (<https://s.id/c1sSy> or <http://iaescore.com/gfa/ijres.docx>).

Make sure to complete the biographies of authors as our template (include links to the 4 authors' profiles, do not delete any icons in the template). Provide links for all authors to the 4 icons (Scholar, Scopus, Publons and ORCID). It is mandatory!!

Instead of using different colors to convey different results in your graphics, use different patterns. Using software such as iThenticate or Turnitin, the similarity rate should be determined (that the result is less than 20 percent). If the similarity index is greater than 20%, your manuscript will be delayed for publication until it falls below 20%.

When you send in all of the above documents and your final paper follows all of the final instructions, your paper will be judged "fully accepted." It will be the date of your paper's acceptance.

Your cooperation is very appreciated.

Thank you

Best Regards,
Assoc. Prof. Dr. Selvakumar Manickam
Editor-in-Chief, IJRES
ijres@iaesjournal.com

A high-quality research report MUST have the following elements:

- (1) a clear definition of the problem addressed by the study --> explain in the "Introduction" section
- (2) the suggested solution(s), method(s), approach(es), framework(s), algorithm(s), etc.
- (3) Achieved outcomes It thoroughly discusses previous work on the subject as well as what is new.

This journal is free and accessible to the public. Why publish open access? IAES open access writers gain from the following: a quality, established, and respected publication, reaching crucial audiences with 5 million readers each month, high citations, and so on. So, the open access fee is paid by the authors, or on their behalf, to support the cost of wide open access dissemination of research results; to pay a deposit to CrossRef in order for each published article to have a Digital Object Identifier (DOI); to manage the various costs associated with handling and editing submitted manuscripts; and journal management and publication in general.

Each accepted paper (written by two or more authors) is charged USD 295 to help pay for some of the publication costs. This fee covers the first 8 pages. Any published manuscript with more than 8 pages will cost an extra USD 50 per page. You can't have just one author. If the author is the only author, the publication fee is USD 450 for the first 8 pages, which is twice the normal fee. Any published manuscript that is longer than 8 pages will cost an extra USD 100 per page. For Indonesian authors, please refer to xe.com for the USD to IDR currency conversion.

The payment should be made by bank transfer (T/T):

Bank Account name/Beneficiary (please be exact): TOLE SUTIKNO

Bank Name: Bank Syariah Indonesia (PT Bank Syariah Indonesia Tbk)*
Branch Office: Yogyakarta Kusumanegara
City: Yogyakarta
Country: Indonesia
Bank Account #: 7168633321
SWIFT Code (BIC) / IBAN: BSMDIDJXXX
*Predecessors: Bank Syariah Mandiri (PT Bank Syariah Mandiri Tbk)
see: https://en.wikipedia.org/wiki/Bank_Syariah_Indonesia

or as alternative, you can pay by using PayPal to email:
INFO@IAESJOURNAL.com

Bank's detailed address:

Bank Syariah Indonesia (BSI)
[Jl. Kusumanegara No.112, Muja Muju, Kec. Umbulharjo](#)
City: Yogyakarta
Province: D.I. Yogyakarta
Country : Indonesia
Post Code: 55165
Indonesia, Phone:+62 274 417222

The Beneficiary's address:

D2, [Griya Ngoto Asri, RT 06, Bangunharjo, Sewon](#)
City: Bantul
Province: D.I. Yogyakarta (DIY)
Post Code: 55187
Country: Indonesia

International Journal of Reconfigurable and Embedded Systems (IJRES)
<http://ijres.iaescore.com>

Transfer Berhasil

Rp6.920.849

Nomor Referensi 68765371

Tanggal Transaksi 15-Januari-2024

Waktu Transaksi 12:39:26 WIB

Layanan Transfer BI-FAST

Bank Tujuan BANK BSI

Nomor Rekening 7168633321

Nama Penerima TOLE SUTIKNO

BIZ ID 20240115BNINIDJA010
00268765371

Nama Pengirim NURMA SARI

Rekening Debet *****078

Tujuan Transaksi Lainnya

Berita Payment paper ID
21040

Nominal Rp6.920.849

Biaya Admin Rp2.500

Total Rp6.923.349





Nurma Sari <nurmasari01@ulm.ac.id>

[IJRES] Certificate of Acceptance

1 message

4excelente.team@gmail.com <4excelente.team@gmail.com>

Wed, Jan 31, 2024 at 10:30 AM

Reply-To: ijres@iaescore.com

To: nurmasari01@ulm.ac.id, yuniarsavitri147@gmail.com, scwahyono@ulm.ac.id, jokosantoso1507@gmail.com, amarvijai01@ulm.ac.id

Dear Prof./Dr./Mr./Mrs. Nurma Sari, Yuniar Savitri, Sri Cahyo Wahyono, Joko Santoso, Amar Vijai Nasrulloh:

We are glad to inform you that your manuscript ID 21040 has been ACCEPTED for publication in the International Journal of Reconfigurable and Embedded Systems (IJRES).

Herewith we send a Certificate of Acceptance for your manuscript.

If there is any inquiry about the certificate, do not hesitate to contact us by this email.

We hope you will submit more manuscripts in the future and spread the journal among your community.

Thank you for your hard work and your cooperation. Stay Positive, Stay Healthy, and Stay Safe.

Mohamad Arif Munandar
IJRES Editorial Office
On behalf of the Editor-in-Chief
Prof. Dr. Paolo Crippa

**IJRES certificate of acceptance for authors ID 21040.pdf**

481K



Scopus[®]
indexed

CiteScoreTracker 2023: **1.3** | h-index: **3**
(Last updated on 05 December, 2023)

SJR SCImago
Journal & Country
Rank

Q3 Electrical and
Electronic
Engineering

SJR 2022	SNIP 2022	CiteScore 2022
0.218	0.143	0.9

International Journal of Reconfigurable and Embedded Systems (IJRES)

CERTIFICATE OF ACCEPTANCE

The manuscript (IJRES-21040) titled:

Design of IoT-based monitoring system for temperature and dissolved oxygen levels in catfish aquaculture pond water

Authored by:

Nurma Sari, Yuniar Savitri, Sri Cahyo Wahyono, Joko Santoso, Amar Vijai Nasrulloh

was accepted in IJRES (ISSN 2089-4864) on 15-01-2024

<https://ijres.iaescore.com>

January 31, 2024



Prof. Dr. Paolo Crippa
Editor-in-Chief

UNIVERSITAS
LAMBUNG MANGKURAT

Nurma Sari <nurmasari01@ulm.ac.id>

[IJRES] Nov'24 - Revision required paper ID 21040

3 messages

IJRES Editorial Office <ijres@iaescore.com>
To: nurmasari01@ulm.ac.id

Tue, Jun 4, 2024 at 10:31 AM

-- Paper ID: 21040
-- Title: Design of IoT-based monitoring system for temperature and dissolved oxygen levels in catfish aquaculture pond water

Dear Prof./Dr./Mr./Mrs.

I am Munandar writing on behalf of the layout and editing team, under the auspices of the International Journal of Reconfigurable and Embedded Systems (IJRES) team. We are very happy to let you know that your paper is in the layout stage for possible publication in the November 2024 issue of this journal. I would need your cooperation for final checking and/or updating your paper. Here we attach the revised file in pdf format. **Just so you know, the author can only revise the comment/marked section (edited by the editing team). Make sure that the author does not add any other revisions except the marked/commented section.**

Please send us the revised/newest version of your article.

Social media ID must be included as the author's identity.

Please complete all author's ID of your social media (orcid ID, Google Scholar, and Publons/web of science). Also, insert a link of Scopus ID if any. The three social media sites are mandatory. Please make improvements to the paper that we attach.

Kindly submit your updated paper within 2 days

Please note that this email is only assigned for layout and editing purposes. For other communication purposes, reach us through the principal contact of the journal.

Your cooperation is highly appreciated.

Healthy regards,
Mohamad Arif Munandar
On behalf of the Editor-in-Chief
Assoc. Prof. Dr. Selvakumar Manickam

 **21040 IJRES 15Jan24 Rev26Oct23 (Ed II) pra pu.docx**
2390K

Nurma Sari <nurmasari01@ulm.ac.id>
To: IJRES Editorial Office <ijres@iaescore.com>

Thu, Jun 6, 2024 at 9:20 AM

Dear Editor,

Thank you for your previous email.
We have revised the manuscript according to the comments in the attached file.

We hope that you find our responds satisfactory and our manuscript can be acceptable for publication.

Sincerely yours,

Nurma sari
[Quoted text hidden]

 **21040 IJRES 15Jan24 Rev26Oct23 (Ed II) pra pu revisi.docx**
2357K

IJRES Editorial Office <ijres@iaescore.com>
To: Nurma Sari <nurmasari01@ulm.ac.id>

Fri, Jun 7, 2024 at 4:47 AM

Dear Prof./Dr./Mr./Mrs. Nurma Sari;

Thanks for sending your updated paper.
We will continue to process the publication of your paper as soon as possible.

I would appreciate your cooperation in checking and/or updating your paper. Thank you

Mohamad Arif Munandar
Layout and Editing Team, IJRES
on behalf of the Managing Director, Journals
Assoc. Prof. Dr. Selvakumar Manickam
[Quoted text hidden]

Design of IoT-based monitoring system for temperature and dissolved oxygen levels in catfish aquaculture pond water

Nurma Sari, Yuniar Savitri, Sri Cahyo Wahyono, Joko Santoso, Amar Vijai Nasrulloh
Physics Study Program, University of Lambung Mangkurat, Banjarbaru, Indonesia

Article Info	ABSTRACT
<p>Article history:</p> <p>Received Jul 20, 2023 Revised Oct 26, 2023 Accepted Jan 15, 2024</p> <hr/> <p>Keywords:</p> <p>Catfish aquaculture pond Dissolved oxygen levels Internet of things-based NodeMCU ESP8266 Temperature</p>	<p>One of the fish in Indonesian waters that has been successfully bred and cultivated is the catfish (<i>Pangasius sp.</i>). In catfish farming, there are several water quality factors that need to be considered, such as temperature and dissolved oxygen levels. Erratic weather patterns cause poor water quality for fish farming, which makes fish susceptible to disease and if it continues will result in mass fish mortality. Based on the existing description, it is very important to pay attention to the water quality of aquaculture ponds, especially temperature and dissolved oxygen levels for fish survival. This study aims to create an internet of things (IoT) based monitoring system for temperature and dissolved oxygen levels in catfish aquaculture pond water based on NodeMCU ESP8266. Monitoring system is using SEN0237 gravity analog dissolved oxygen sensor, DS18B20 sensor module, NodeMCU ESP8266, 20x4 character liquid-crystal display (LCD), micro secure digital (SD) card module, internet modem. Data from measurements of temperature and dissolved oxygen levels are stored online in the Adafruit.io database in the .csv format and on a micro SD card in the device in the .txt format. The effective value of the probe filling solution on the SEN0237 analog dissolved oxygen sensor is around 3-4 hours. During the 3 days measurement, the lowest value of dissolved oxygen levels and temperature are 3.4 mg/L or 3.4 ppm and a temperature of 27.9 °C, respectively. Meanwhile, the highest value of dissolved oxygen levels and temperature are 4.6 mg/L or 4.6 ppm and temperature of 30.9 °C, respectively.</p> <p><i>This is an open access article under the CC BY-SA license.</i></p> 

Corresponding Author:
Nurma Sari
Physics Study Program, University of Lambung Mangkurat
70714, Banjarbaru, Kalimantan Selatan, Indonesia
Email: nurmasari01@ulm.ac.id

1. INTRODUCTION

Catfish is one of the native fish in Indonesian waters that grows well. Catfish is a freshwater fish that belongs to the catfish (*Pangasius sp.*) type. Pangasidae can be mass-produced and offers the potential for industrial-scale development due to its basic characteristics of lacking scales, having few spines, having a fairly fast growth rate, and having high fertility and survival rates. With all these benefits, this fish has increased economic value among fishery commodities, both in the hatchery and grow-out business sectors [1], [2]. In recent times, real time water quality monitoring in aquaculture has been brought by the fast development of internet of things (IoT) technology effectively. Globally, water quality monitoring systems based on IoT and wireless communication technologies have been widely studied intensively [3]–[6], [7]–[13].

Dissolved oxygen levels are one of the water quality parameters that can cause large numbers of fish to die. The processes of decomposition, reproduction and development in ponds are hampered by low dissolved oxygen levels. According to Indonesian National Standard (SNI) number 01-6483.3-2000 for

Commented [I1]: Your abstract is too long, it's better to shorten it again into max. 200 words

catfish culture, dissolved oxygen levels range from >4 mg/L. The need for fish for dissolved oxygen levels depends on the age of the fish, fish activity, and water quality [14]. Dissolved oxygen levels in ponds vary from time to time. Research show that dissolved oxygen levels change due to the influence of changing temperatures due to unstable weather [15]. According to Effendi [16], dissolved oxygen levels for fisheries must be at least 5 mg/L. If the concentration of dissolved oxygen is not balanced, the fish will be stressed because the brain does not get enough oxygen. Fish will experience anoxia because their body tissues are unable to bind dissolved oxygen in the blood.

The water temperature of fish farming ponds is an important factor. The ideal temperature tolerance range for catfish according to SNI number 01-6483.3-2000 is between 25-30 °C. Pool water temperature affects water quality [17]. Oxygen solubility is one of the characteristics of water quality that is affected by temperature variations. With increasing temperature, the level of solubility of oxygen decreases [18], [19]. Once there is an increase in temperature, the amount of solubility of oxygen in water will decrease. An increase in temperature causes the metabolic activity of fish to be greater which results in a doubling of oxygen consumption in fish. Low water temperature can affect the ability of fish to bind oxygen so that it can inhibit fish development [20]. Fish that experience stress reduce stamina and reduce hunger, and eventually starve to death [16].

The DS18B20 temperature sensor is a device that can read temperature variations and then translate these changes into electrical quantities. This sensor is connected to the microcontroller using a single cable and is a digital sensor. These sensors are special because each sensor contains a serial code that allows the use of multiple DS18B20s in one-wire transmission. This sensor can be used with 3.0 to 5.5 V. The sensor has ± 0.5 °C accuracy from -10 to +85 °C and can be used in the temperature range of -55 to 125 °C (-67 to +257 °F) with a resolution of 9 to 12 bits [21]. SEN0237 gravity analog dissolved oxygen sensor is a sensor for measuring dissolved oxygen levels in water. These sensors are widely used in various water-related sectors, including research, aquaculture, and monitoring of the aquatic environment. This sensor is open source and compatible with various microcontrollers, allowing users to use it freely and openly. This sensor has a galvanic probe type with a detection range of 0 to 20 mg/L. This sensor has a response time of up to 98% full response, within 90 seconds (25 °C) sensor pressure range from 0 to 50 PSI with electrode service life generally for 1 year for normal use [22]. NodeMCU ESP8266 is a microcontroller equipped with the ESP8266 chip. This microcontroller has multiple input or output ports to enable monitoring and control applications for IoT projects. The NodeMCU ESP8266 is an evolution of the ESP8266 version of the ESP-12 IoT platform module family. This module works very similarly to the Arduino module platform in terms of functionality, but the difference is "connected to the internet" [23].

Several studies that have been conducted regarding the measurement of water quality in aquaculture ponds. For instance, Mardhiya *et al.* [24] in 2017 was working on a data acquisition system for measuring dissolved oxygen levels with the results that the average dissolved oxygen level is in the range of 3 to 5 mg/L in rainy conditions and between 3 to 7 mg/L on cloudy conditions. Next, research by Sumardiono *et al.* [25] in 2020, was showing a system for monitoring temperature and dissolved oxygen levels in catfish ponds with the Raspberry Pi that was obtained the water temperature varied with time. Furthermore, research by Suriana *et al.* [26] in 2021 built a temperature remote monitoring system in Bangkok tilapia ponds, the effective temperature for fish pond water was an indicator of 28 to 30 °C. To fill the needs of fish consumes, aquaculture methods have been forced to overproduce and resulting in the accelerated water environment degradation and the old of agricultural workers in many parts of the world so will face the dilemma of shortage of labor, and IoT aquaculture method is one of the method that can resolve the issue [27]. Fish farming has been applied widely recently. In Bangladesh, fish monitoring had been studied based on IoT so it notified the user the amount of dissolved oxygen, ammonia level, pH level, and water body temperature. It can help fish farmers to measure the parameters and provide necessary things to grow more fish and facing water pollution [28]. Latest research by Loh *et al.* [29] showed that to address the challenges of maintaining aquatic environment, IoT fish farm monitoring system has been done to provide several features such as temperature, pH, dissolved oxygen, total dissolved solid, and energy usage of the water pump.

Erratic weather patterns cause poor water quality for fish farming, which makes fish susceptible to disease and if it continues will result in mass fish mortality. Based on the existing description, it is very important to pay attention to the water quality of aquaculture ponds, especially temperature and dissolved oxygen levels for fish survival. In this research, a remote and IoT based monitoring system for temperature and dissolved oxygen levels in catfish farming ponds will be made using the DS18B20 and SEN0237 gravity analog dissolved oxygen sensor internet-based sensors which will be tested and implemented in catfish farming ponds. This monitoring system uses NodeMCU ESP8266 as a microcontroller and Adafruit.io as an online interface. By applying IoT technology with an internet network, this up-to-date technology is able to send data and offer speed and a vast distance [30]. This research develops IoT technology for sending

parameter data from dissolved oxygen level and temperature directly to a web server. Then, the stored data for 24 hours on the webserver can be processed for further identification all the time.

2. RESEARCH METHOD

2.1. Material

The materials used are the sensor modules which are DS18B20 temperature sensor and SEN0237 gravity analog dissolved oxygen sensor. Next is the microcontroller kit that consists of NodeMCU ESP8266, 20×4 character liquid-crystal display (LCD) with inter-integrated circuit (I2C) and secure digital (SD) card module. It is also supported by 12 V 2 A adapter, step down DC to DC converter, tin, electronic components, connecting cables, and control panel box.

2.2. Method

2.2.1. Hardware

The proposed of the NodeMCU ESP8266-based IoT monitoring system for temperature and dissolved oxygen consists of several stages starting with preparing the tools and materials needed in this research (Figure 1). It proceeds with assembling the hardware, namely integrating the NodeMCU ESP8266 with the sensor, and assembling a remote monitoring system for temperature and dissolved oxygen based on the NodeMCU ESP8266. Furthermore, the manufacture of software includes the manufacture of microcontroller software, manufacture of LCD interface software and manufacture of IoT software. Followed by determining the transfer function of measuring instruments, testing the system as a whole and finally data collection. The details of the proposed system can be seen clearly in Figure 1(a). Meanwhile, Figure 1(b) shows layout of the circuit design of remote monitoring of temperature and dissolved oxygen levels based on Node MCU ESP8266. It is included SEN0237 analog dissolved oxygen sensor, DS18B20 sensor, SD Card module, and 20×4 characters I2C LCD module are integrated into the NodeMCU ESP8266.

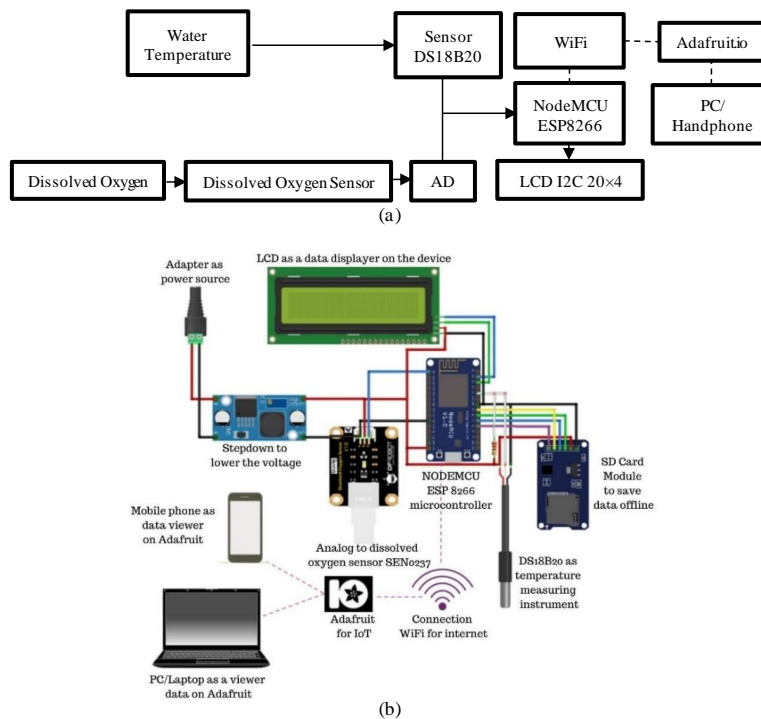

Figure 1. Proposed system of (a) block diagram and (b) circuit design

2.2.2. Software

Figure 2 shows the function of NodeMCU ESP8266 for both with sensors and LCD and also with IoT. The software on NodeMCU ESP8266 is made using the Arduino IDE software. The software interface to LCD using Arduino IDE software that connecting between NodeMCU ESP8266 and sensors (DS18B20 dan SEN0237 analog dissolved oxygen sensor). The stages include LCD pin configuration, library input, and giving commands to retrieve data from the output of the measuring instrument circuit. The flowchart of the programme interface to display characters on the LCD can be seen in Figure 2(a).

Calibration was accomplished by comparing the measured value on the sensor with the measured value on a standard measuring instrument. For the DS18B20 sensor, a digital thermometer is used as a comparison. The measurement range used is 10 to 50 °C. Meanwhile, for the SEN0237 grativity analog dissolved oxygen sensor, a dissolved oxygen meter is used as a comparison. Measurements were made using zero dissolved oxygen powder which was added little by little until a measured dissolved oxygen value of 0 mg/L was obtained.

Figure 2(b) presents connection of NodeMCU ESP8266 with IoT. The system developed by the Arduino IDE software and the IoT interface used Adafruit.io. In details, to connect NodeMCU ESP8266 with IoT, it is mandatory to write down the wifi name and password of the wifi used. To link readings to Adafruit.io, the listing should include the Adafruit.io web address, the username of the Adafruit.io account used, the active key, and the name of the feed used. The monitoring system that is made is tested first by observing each part whether it is working properly. Next, a performance check of the NodeMCU ESP8266 is carried out by connecting to the internet so that it reads Adafruit.io. After connected to the internet and a notification appears that Adafruit.io has been connected, a comparing the values between on the LCD of the device and Adafruit.io. Once the reading value of the measuring instrument that appears is appropriate, the tool can be used.

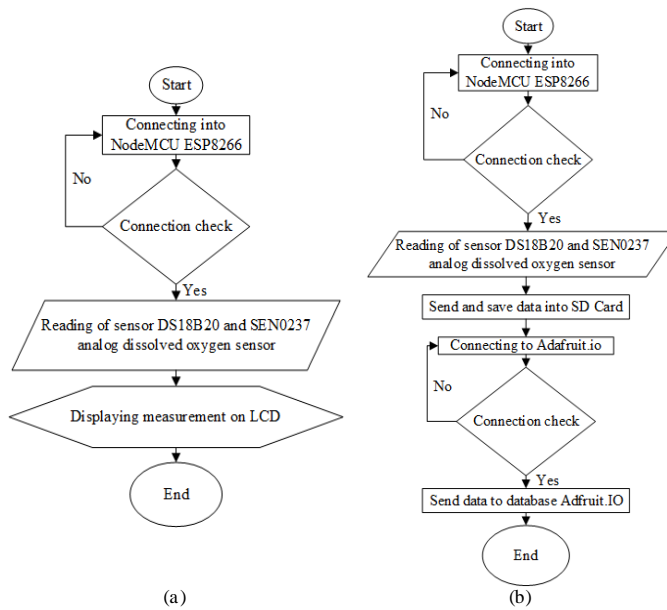

Figure 2. Flowchart of NodeMCU ESP8266 with (a) sensors and LCD and (b) IoT

Calibration was accomplished by comparing the measured value on the sensor with the measured value on a standard measuring instrument. For the DS18B20 sensor, a digital thermometer is used as a comparison. The measurement range used is 10 to 50 °C with the sensor readings obtained, the (1) is obtained.

$$y = 1,0129x + 0,2557 \text{ with } R^2 = 1 \quad (1)$$

The (1) is then entered into the Arduino program. It is intended that the readings from the DS18B20 sensor are the same as standard measuring instruments. After the equation is entered into the Arduino program, retesting is carried out with a temperature range of 20 to 35 °C as a representative of the reasonable limit for measuring catfish pond water. Data on the results of retesting the DS18B20 sensor can be seen in Table 1. Meanwhile, for the SEN0237 gravimetric analog dissolved oxygen sensor, a dissolved oxygen meter is used as a comparison. Measurements were made using zero dissolved oxygen powder which was added little by little until a measured dissolved oxygen value of 0 mg/L was obtained. Based on the sensor readings obtained, the (2) is obtained.

$$y = 126,22x - 129,85 \text{ with } R^2 = 0,9664 \quad (2)$$

The (2) is then entered into the Arduino program. This aims to convert the reading from SEN0237 analog dissolved oxygen sensor into mg/L like the reading from dissolved oxygen meter. After the equation is entered into the Arduino program, a retest is carried out using PDAM water with calibration powder added little by little until the dissolved oxygen level in local government-owned water utility (PDAM) water becomes 0 mg/L. The data of SEN0237 analog dissolved oxygen sensor retest can be seen in Table 2.

Table 1. DS18B20 sensor retest result data

No	Calibrator (\bar{x})	DS18B20 sensor (\bar{x}_i)	Difference ($\bar{x}-\bar{x}_i$)	Error (%)
1	20	20	0	0.00
2	21	21.02	-0.02	0.10
3	22	22.03	-0.03	0.14
4	23	23.04	-0.04	0.17
5	24	23.99	0.01	0.04
6	25	25.00	0.00	0.00
7	26	26.02	-0.02	0.08
8	27	27.03	-0.03	0.11
9	28	28.04	-0.04	0.14
10	29	28.99	0.01	0.03
11	30	30.01	-0.01	0.03
12	31	31.02	-0.02	0.06
13	32	32.03	-0.03	0.09
14	33	33.04	-0.04	0.12
15	34	34.06	-0.06	0.18
16	35	35.01	-0.01	0.03
Error mean				0.1

Table 2. Result of the retest data on SEN0237 analog dissolved oxygen sensor

No	Calibrator (\bar{x})	SEN0237 sensor (\bar{x}_i)	Difference ($\bar{x}-\bar{x}_i$)	Error (%)
1	6.50	6.82	-0.32	4.92
2	6.03	6.57	-0.54	8.9
3	5.90	6.07	-0.17	2.82
4	5.70	5.58	0.12	2.05
5	5.27	5.18	0.09	1.71
6	4.53	4.35	0.18	4.12
7	3.80	3.09	0.71	18.77
8	2.53	1.75	0.78	31.05
Error mean				9.3

2.2.3. System realization

Figures 3 show the location and configuration of the equipment and its placement in the catfish farming pond. Pre-data collection was retrieved for 2 days to determine the readiness of the tool before the actual data collection was carried out. Pre-data collection was carried out during weather conditions after rain and in ponds with cloudy weather conditions accompanied by rain. Data monitoring can be monitored via mobile phones and laptops or other devices that can access the internet. To monitor the measurement results via the internet, users can open the link that has been provided for this monitoring system. Measurements will begin when the NodeMCU ESP8266 microcontroller is connected to the internet. The process of connecting the microcontroller to the internet takes ± 40 seconds depending on the speed of internet access. The better the internet network used, the faster the microcontroller is connected. If the internet network is disconnected, the data displayed is the last data before the network is disconnected. This monitoring system has a weakness in

the dissolved oxygen sensor used, which is a probe filling solution sensor that must always be monitored. During the pre-take, it is known that the effective use of the probe filling solution is about 3-4 hours. Therefore, every 3-4 hours it is necessary to check and replace the probe filling solution so that the measurement results obtained have a good value. The probe filling solution used should always be in good condition and no bubbles should form on the filling membrane. The formation of bubbles and poor probe filling solution can affect the measurement results.

Location of the ponds in this research can be clearly seen in Figure 3(a). The laying tools in the field using a box that is given a hole and then associated with a paralon pipe tied to the bridge. The tool box, modem, and power outlet (Figure 3(b)) are placed in a green box which is then given a hole for the sensor probe. The sensor probe is connected to the outside of the box and then inserted into the paralon pipe that has been tied to the bridge to prevent the position of the probe from moving if it is hit by a fish that has an impact on the measurement (Figure 3(c)).

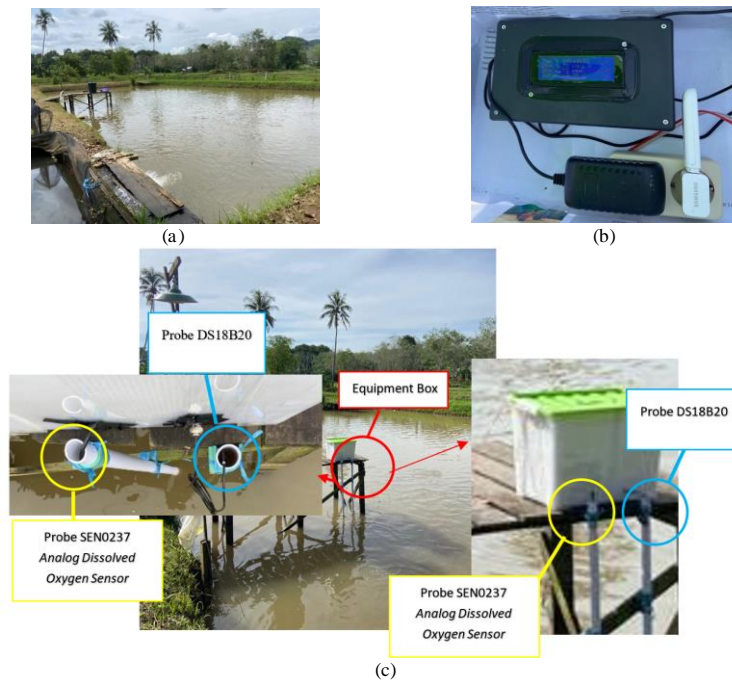

Figure 3. The location and configuration of the equipment and its placement in the catfish farming pond by (a) location of catfish ponds where data is collected, (b) measurement and IoT system processing equipment, and (c) IoT based monitoring system for temperature and dissolved oxygen levels in catfish farming ponds

3. RESULTS AND DISCUSSION

The calibration process of the SEN0237 analog dissolved oxygen sensor. Measurements were carried out three times using water mixed with zero dissolved oxygen powder until the dissolved oxygen level in the water was 0 mg/L. Based on the results of the sensor readings obtained the regression formula in (2) and adapted into Arduino program. From the results of retesting conducted, it is known that the average error in sensor readings is 9.3% (Table 2). Meanwhile, based on the results of the DS18B20 temperature sensor during calibration, it is obtained the regression formula in (1). This equation is then adapted into the Arduino program. It is intended that the readings from the DS18B20 sensor are the same as standard

measuring instruments. From the results of retesting, it is known that the average error value of reading is 0.1% (Table 1).

The readings that appear on the [Adafruit IO](#) dashboard are temperature, dissolved oxygen (mg/L), and dissolved oxygen (ppm) in the form of images and gauges. Figure 4 is the interface display on [Adafruit IO](#). The gauge is given a limit value, where if the dissolved oxygen value is below 4 mg/L or 4 ppm and the temperature is below 25 °C and more than 30 °C then the gauge will turn red as a sign that the measurement was carried out in a condition that is not in accordance with SNI number 01-6483.3-2000. Meanwhile, when the measurement results are >4 mg/L or 4 ppm for dissolved oxygen and the temperature is around 25-30 °C, the gauge will turn green. Data display indicators for monitoring can be said to be real-time if the interface for sensor readings that appear on the LCD and the [Adafruit.io](#) dashboard is "same". Figure 5 shows the real-time readings of the [Adafruit.io](#) LCD and dashboard.

Commented [I2]: [Adafruit.io?](#)

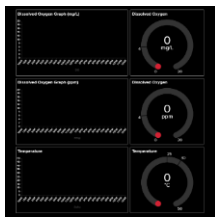

Figure 4. [Adafruit.io](#) display developed Figure 5. Testing and validating of the IoT-based system

Data measurement from the downloaded of [Adafruit.io](#) database is in .csv file format, while stored on the micro SD card is in the .txt file format (Figure 6). Data stored in the [Adafruit.io](#) database can be downloaded in .csv file format for each feed (Figure 6(a)). Along side stored online in the [Adafruit.io](#) database, measurement data is also stored offline on a micro SD card in the form of a .txt file. The stored data contains time data, SEN0237 analog dissolved oxygen sensor readings in mg/L and ppm units, as well as DS18B20 sensor module readings which are separated by commas “,”. This data can be converted into an spreadsheet table for comparative image analysis. Figure 6(b) shows the .txt file data written to and stored on the micro SD card.

id,value,feed_id,created_at,lat,lon,ele	A	B	C	D	E	F	G	H
1	id,value,feed_id,created_at,lat,lon,ele							
2	0F8ZMTEB5P0V2G3B9WNSP8RBTG.1.03,2490571,2023-03-30 05:29:32 UTC...							
3	0F8ZMFX9RQ7LRJSD2E19HWMBP4.1.03,2490571,2023-03-30 05:29:42 UTC...							
4	0F8ZMZD07XMECCG56Z27G1K1.1.03,2490571,2023-03-30 05:29:52 UTC...							
5	0F8ZMZG3W6J1VXYRE03KHPVRL1.1.03,2490571,2023-03-30 05:30:02 UTC...							
6	0F8ZM2K6SR0CQ08P81KCD04H.1.03,2490571,2023-03-30 05:30:13 UTC...							
7	0F8ZM2N4MY7EV7P9VCVQ0G8H.1.03,2490571,2023-03-30 05:30:23 UTC...							
8	0F8ZM2C0THW030T3QVFW3F2C.1.03,2490571,2023-03-30 05:30:33 UTC...							
9	0F8ZM2F28NG7W7Q6YMSC29Q68.1.03,2490571,2023-03-30 05:30:43 UTC...							
10	0F8ZMZWSG7767G9HRJ26QVZ1G.1.03,2490571,2023-03-30 05:30:53 UTC...							
11	0F8ZM2Q7F1KRUT758N89309.1.03,2490571,2023-03-30 05:31:07 UTC...							
12	0F8ZM2C6W112W6A47NGL3H.1.03,2490571,2023-03-30 05:31:14 UTC...							
13	0F8ZMZV8XFG81204HKCEKAX39.1.03,2490571,2023-03-30 05:31:24 UTC...							
14	0F8ZM2ZCRTJ0T7X7Q422E6S6A.1.03,2490571,2023-03-30 05:31:34 UTC...							
15	0F8ZM2G2Q9N0T2VFN7Y81B2.1.03,2490571,2023-03-30 05:31:44 UTC...							
16	0F8ZM2K5F90CJMPAN9GH38R0.1.03,2490571,2023-03-30 05:31:54 UTC...							
17	0F8ZM2N809G0P13W4H04M2K8E.1.03,2490571,2023-03-30 05:32:05 UTC...							
18	0F8ZM2N809G0P13W4H04M2K8E.1.03,2490571,2023-03-30 05:32:15 UTC...							
19	0F8ZM2K5F90CJMPAN9GH38R0.1.03,2490571,2023-03-30 05:32:25 UTC...							
20	0F8ZM2J07EP5153C87WY2HC.1.03,2490571,2023-03-30 05:32:35 UTC...							
21	0F8ZM2N41RY9Z8131V42YCT0T.1.03,2490571,2023-03-30 05:32:45 UTC...							
22	0F8ZM2N41RY9Z8131V42YCT0T.1.03,20230410-0214							

(a)

Waktu,Dissolved Oxygen (mg/L),Waktu,Dissolved Oxygen (ppm)
07:27:19,2.55,2.55,26.91
07:27:30,2.50,2.50,27.73
07:27:40,2.55,2.55,27.67
07:27:50,2.47,2.48,27.67
07:28:00,2.52,2.52,27.67
07:28:10,27.37,27.40,27.67
07:28:21,8.79,8.80,27.60
07:28:31,7.84,7.85,27.54
07:28:41,7.48,7.49,27.35
07:28:51,7.48,7.49,27.16
07:29:01,7.05,7.05,27.35
07:29:12,4.95,4.96,27.22
07:29:22,3.96,3.96,27.79
07:29:32,3.50,3.50,27.86
07:29:42,3.52,3.52,27.86
07:29:52,3.39,3.40,-128.38
07:30:03,3.39,3.40,27.86
07:32:53,3.50,3.50,27.86
07:34:34,3.27,3.27,27.86
07:34:44,3.34,3.34,27.86
07:37:06,3.29,3.29,27.86

(b)

Figure 6. Display of measurement results data of (a) the downloaded from the [Adafruit.io](#) database in .csv file format and (b) the .txt file data written to and stored on the micro SD card

Data collection was retrieved for three days (Figure 7). The measuring instrument is placed on a bridge with a height of ±80 cm from the water surface with the sensor probe submerged about 2-4 cm from the water surface. During data collection, the weather is constantly changing. Data collection on first day was

in cloudy weather conditions accompanied by rain during the day. The relationship between temperature and dissolved oxygen levels from data collection on the first day can be seen in Figure 7(a). From the figure it is known that when the temperature increases the dissolved oxygen levels decrease and vice versa. From the Figure 7(a), the relationship between temperature and dissolved oxygen levels is most clearly seen at point a at 13:15, where the dissolved oxygen value reaches 4.5 mg/L or 4.5 ppm with a measured temperature of 28.6 °C. It also shows a decrease in dissolved oxygen values and temperature due to rain during the day, from 13:15 to 14:30. Apart from when it rains, dissolved oxygen values and measured temperatures also tend to decrease at night at 19:15. The dissolved oxygen value measured after rain and at night fell below 4 mg/L.

Data collection on second day was cloudy in the morning, then hot during the day and cloudy again in the late afternoon. Figure 7(b) is a graph of the relationship between temperature and dissolved oxygen levels. From the Figure 7(b) it is known that when the temperature increases the dissolved oxygen level decreases and vice versa as seen at 19:30 to 20:00. In some conditions there are temperature values that are not in accordance with the theory, such as at points d to e where the temperature values measured exceed the value of 30 °C at 13:00 to 17:30 caused by the hot sun during the day. The dissolved oxygen value between 10:00 and 11:30 is measured to be less than 4 mg/L in the morning with cloudy weather conditions after rain. The low dissolved oxygen value measured is the dissolved oxygen value measured at the time of changing the probe filling solution because when changing the probe is removed from the water. The low dissolved oxygen measured, aside from the effect of temperature, is also caused by other factors such as the water level and the water content.

Data collection on third day in sunny weather conditions in the morning then hot during the day, cloudy in the late afternoon accompanied by rain at night. Figure 7(c) is a graph of the relationship between temperature and dissolved oxygen levels. The Figure 7(c) during the temperature increases the dissolved oxygen levels decrease and vice versa. The relationship between temperature and dissolved oxygen can be seen at 15:45 to 17:15 once dissolved oxygen increases the temperature value decreases. In some conditions there are temperature values measured outside the limits of SNI provisions at 11:30 to 16:30 with the measured values are more than 30 °C. This condition occurs due to the hot weather during the day that causes the temperature to increase. Dissolved oxygen values that were measured outside the regulatory limits were seen between 10:00 and 10:45 and at 17:15 to 20:00, where dissolved oxygen values were measured below 4 mg/L. The low dissolved oxygen measured apart from temperature is also caused by other factors such as water level and water content. From the data image, the most obvious one is at 14:00 where the dissolved oxygen value reaches 4.2 mg/L or 4.2 ppm with a measured temperature of 30.9 °C.

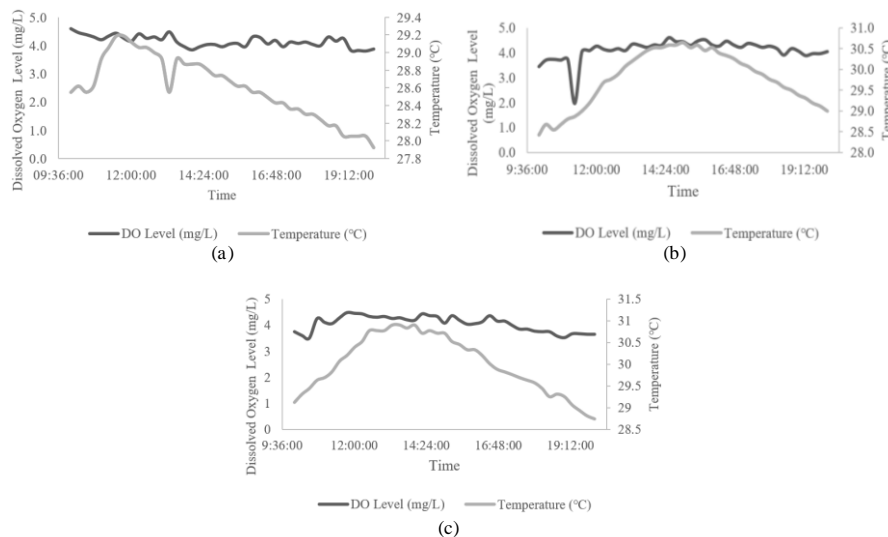

Figure 7. Data collection of dissolved oxygen level (black line) and temperature (gray line) for three days (a) first day, (b) second day, and (c) third day data collection

Based on measurements carried out for three days, from 10:00 to 20:00 (Table 3), it is known that the temperature and dissolved oxygen values of the Karang Intan catfish pond are relatively safe and quite good. In the morning dissolved oxygen in fish pond water is quite low, then it increases as the day progresses. When it rains, the measured dissolved oxygen levels also decrease. This is similar to research conducted by Mardhiya *et al.* [24] in 2017 which obtained an average dissolved oxygen level in the range of 3 to 5 mg/L in rainy conditions and a range of 3 to 7 mg/L in cloudy conditions. Abundant oxygen levels during the day with sunny weather due to the process of respiration by macrophytes in the mechanism of photosynthesis with the help of sunlight. While at night dissolved oxygen decreased again. The decrease in dissolved oxygen levels at night is due to the absence of photosynthesis at night, also caused by the level of temperature fluctuations by the air, the increased respiration rate of sediment by bacteria and the more intense respiration rate in fish ponds by aquatic organisms. As for the temperature, it is influenced by the surrounding conditions. As the day gets darker, when the weather is cloudy and it rains, the measured temperature decreases and vice versa, when the weather is sunny and the sun is hot enough, the measured temperature increases. This is similar to research conducted by Sumardiono *et al.* [25] in 2020, for example when it is sunny the temperature will rise to around 29 °C, when it is foggy it will drop to around 27.7 °C, and at night it will generally drop to around 29.4 °C. The graph of the maximum and minimum values of dissolved oxygen and temperature measured for 3 days can be seen in Figure 8.

Table 3. Maximum and minimum values of data for three days of measurement

Day	Time	Dissolved oxygen (mg/L)			Temperature (°C)			
		Max	Time	Min	Time	Max	Min	
1	10:00:01	4.6	19:45:01	3.81	11:45:09	29.19	20:00:37	27.92
2	14:30:15	4.6	10:00:42	3.44	15:00:09	30.64	10:00:42	28.43
3	11:45:20	4.49	10:30:05	3.5	13:30:38	30.9	20:00:12	28.74

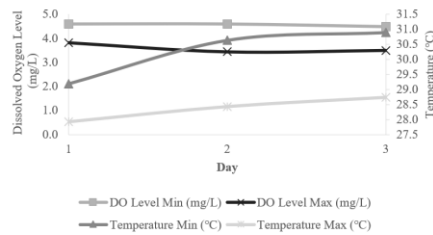

Figure 8. The maximum and minimum values of dissolved oxygen level and temperature of 3 days of measurement

In Figure 8 it can be seen that dissolved oxygen tends to be lower in the morning, then increases as the day progresses. During 3 days the measurement was carried out, the dissolved oxygen levels and temperature measured during the measurement had the lowest value of 3.44 mg/L or 3.44 ppm with a temperature of 27.92 °C and the highest value of 4.6 mg/L or 4.6 ppm with a temperature of 30.9 °C. From the measurements taken, it is known that dissolved oxygen levels have good values during the daytime, while in the morning and night have poor values. The maximum value of dissolved oxygen that was measured was obtained at 10:00, 14:30, and 11:45. At night dissolved oxygen tends to decrease, where from the data obtained it is recorded that the minimum dissolved oxygen value is at 19:45, 10:00, and 10:30. Meanwhile, the temperature tends to increase during the day and decreases in the afternoon until the evening. From the data recorded from measurements for three days, it was found that the temperature experienced a maximum value at 11:45, 15:00, and 13:30. The minimum temperature recorded is at 20:00 and 10:00. The low temperature measured in the morning is caused by temperature changes that occur at night accompanied by rain, so that when measurements are taken in the morning the measured temperature tends to be low. From the measurement data obtained, it is known that dissolved oxygen levels are indeed affected by temperature, but this factor does not have a significant effect. There are other factors that affect dissolved oxygen levels in fish pond water. Even so, the water quality measured in the catfish pond is fairly good because the dissolved oxygen and measured temperatures are still within safe limits. The circulation of fish pond water is quite good so that even though the measured dissolved oxygen was below the SNI number 01-6483.3-2000

standard for catfish cultivation, dissolved oxygen can again increase to the threshold according to SNI number 01-6483.3-2000. This system also spent a low cost for its operation. In details, for the distilled water solution as a neutralizer or rinsing probes before and after use, approximately 500 ml of distilled water is enough for one week of data collection. As for probe filling or NaOH liquid, approximately 30 ml is enough for one week of data collection. Cost calculation for 1 week, 500 ml of distilled water costs USD 0.45 and 30 ml of 0.5 molar NaOH costs USD 0.032 so the total cost for 1 week is USD 0.48. (USD 1=IDR 15,719).

4. CONCLUSION

An IoT-based monitoring system for temperature and dissolved oxygen levels in catfish farming ponds using the DS18B20 and an internet-based dissolved oxygen sensor has been successfully developed. This monitoring system are able to measure temperature and dissolved oxygen levels which have a reading error value for the DS18B20 sensor of 0.1% and for the SEN0237 analog dissolved oxygen sensor 9.3%. The effective value of the probe filling solution on the SEN0237 analog dissolved oxygen sensor is around 3-4 hours. A water quality monitoring system has been implemented in catfish pond in Karang Intan for 3 days starting from 10:00 to 20:00. From the measurements that have been made, it is obtained that the dissolved oxygen level and temperature measured during the measurement have the lowest value of 3.4 mg/L or 3.4 ppm with a temperature of 27.9 °C and the highest value of 4.6 mg/L or 4.6 ppm with a temperature of 30.9 °C. The main limitation of the dissolved oxygen sensor is the effective use of the probe filling solution is about 3-4 hours. Therefore, every 3-4 hours it is necessary to check and replace the probe filling solution. In the future, dissolved oxygen sensor replacement with longer lifetime of used for the probe filling solution replacement. This future research also using photovoltaic cells as independent energy to supply to system so it can be implemented into remote ponds that are unavailable electricity source.

REFERENCES



- [1] Idawati, N. Defira, and S. Mellisa, "Pengaruh pemberian pakan alami yang berbeda terhadap pertumbuhan dan kelangsungan hidup benih ikan patin (*Pangasius sp.*).", *Jurnal Ilmiah Mahasiswa Kelautan dan Perikanan Unsyiah*, vol. 3, no. 1, pp. 14–22, 2018.
- [2] Y. Sukrismon, Aripriharta, N. Hidayatullah, N. Mufti, A. N. Handayani, and G. J. Homg, "Smart fish pond for economic growing in catfish farming," in *2019 International Conference on Computer Science, Information Technology, and Electrical Engineering (ICOMITEE)*, IEEE, Oct. 2019, pp. 49–53. doi: 10.1109/ICOMITEE.2019.8921233.
- [3] D. S. Simbeye and S. F. Yang, "Water quality monitoring and control for aquaculture based on wireless sensor networks," *Journal of Networks*, vol. 9, no. 4, pp. 849–849, Apr. 2014, doi: 10.4304/jnw.9.4.840-849.
- [4] L. Xu, N. Wang, Y. Feng, D. Bao, and K. Jorshin, "Design of aquaculture system based on wireless monitoring and its testing," *International Journal of Online and Biomedical Engineering (iJOE)*, vol. 10, no. 5, p. 68, Sep. 2014, doi: 10.3991/ijoe.v10i5.4035.
- [5] L. Hongpin, L. Guanglin, P. Weifeng, S. Jie, and B. Qiuwei, "Real-time remote monitoring system for aquaculture water quality," *International Journal of Agricultural and Biological Engineering*, vol. 8, no. 6, pp. 136–143, 2015, doi: 10.3965/ijabe.20150806.1486.
- [6] C. Encinas, E. Ruiz, J. Cortez, and A. Espinoza, "Design and implementation of a distributed IoT system for the monitoring of water quality in aquaculture," in *2017 Wireless Telecommunications Symposium (WTS)*, IEEE, Apr. 2017, pp. 1–7. doi: 10.1109/WTS.2017.7943540.
- [7] M. Zhang, D. Li, L. Wang, D. Ma, and Q. Ding, "Design and development of water quality monitoring system based on wireless sensor network in aquaculture," in *IFIP Advances in Information and Communication Technology*, vol. 347 AICT, no. PART 4, 2011, pp. 629–641. doi: 10.1007/978-3-642-18369-0_76.
- [8] S. Saha, R. Hasan Rajib, and S. Kabir, "IoT based automated fish farm aquaculture monitoring system," in *2018 International Conference on Innovations in Science, Engineering and Technology (ICISSET)*, IEEE, Oct. 2018, pp. 201–206. doi: 10.1109/ICISSET.2018.8745543.
- [9] C. Dupont, P. Cousin, and S. Dupont, "IoT for aquaculture 4.0 smart and easy-to-deploy real-time water monitoring with IoT," in *2018 Global Internet of Things Summit (GIoTS)*, IEEE, Jun. 2018, pp. 1–5. doi: 10.1109/GIoT.2018.8534581.
- [10] L. Parra, S. Sendra, L. Garcia, and J. Lloret, "Design and deployment of low-cost sensors for monitoring the water quality and fish behavior in aquaculture tanks during the feeding process," *Sensors*, vol. 18, no. 3, p. 750, Mar. 2018, doi: 10.3390/s18030750.
- [11] M. Li, C. Lin, J. Ren, and F. Jiang, "A wireless ecological aquaculture water quality monitoring system based on LoRa technology," in *Proceedings of the 2019 International Conference on Wireless Communication, Network and Multimedia Engineering (WCNME 2019)*, Paris, France: Atlantis Press, 2019, pp. 5–7. doi: 10.2991/wcnme-19.2019.2.
- [12] F. A. Saparudin, T. C. Chee, A. S. A. Ghafar, H. A. Majid, and N. Katiran, "Wireless water quality monitoring system for high density aquaculture application," *Indonesian Journal of Electrical Engineering and Computer Science (IJECS)*, vol. 13, no. 2, pp. 507–513, Feb. 2019, doi: 10.11591/ijeecs.v13.i2.pp507-513.
- [13] L. V. Q. Danh, D. V. M. Dung, T. H. Danh, and N. C. Ngoc, "Design and deployment of an IoT-based water quality monitoring system for aquaculture in Mekong Delta," *International Journal of Mechanical Engineering and Robotics Research*, vol. 9, no. 8, pp. 1170–1175, 2020, doi: 10.18178/ijmerr.9.8.1170-1175.
- [14] Y. Fujaya, *Fisiologi ikan: dasar pengembangan teknologi perikanan*, no. 1, Rineka Cipta. Jakarta, 2004.
- [15] W. H. Siegers, Y. Prayitno, and A. Sari, "Pengaruh kualitas air terhadap pertumbuhan ikan nila (*Oreochromis Sp.*) Pada Tambak Payau," *The Journal of Fisheries Development*, vol. 3, no. 11, pp. 95–104, 2019.
- [16] H. Effendi, *Telaah kualitas air bagi pengelolaan sumber daya dan lingkungan perairan*. Yogyakarta: Kanisius, 2003.

Commented [I3]: [1], [14],[15],[16],[23], [24], [25], [26]: We do not appreciate a local journal with local language as a reference. We strongly recommend you change this reference into another one from an international journal that uses English.



- [17] J. S. Lucas and P. C. Southgate, Eds., *Aquaculture: farming aquatic animals and plants, 2nd Edition Edited book Peer reviewed Aquaculture: farming aquatic animals and plants*, 2nd ed. Wiley, 2012. doi: 10.1002/9781118687932.
- [18] D. A. Chin, *Water-quality engineering in natural systems*. Wiley, 2006. doi: 10.1002/0471784559.
- [19] R. Parker, "Review of life cycle assessment research on products derived from fisheries and aquaculture," Sea Fish Industry Authority, 2012.
- [20] C. E. Boyd and F. Lichtkoppler, *Water quality management in pond fish culture*, no. 22. Auburn: Auburn University, 1979.
- [21] "DS18B20 programmable resolution 1-wire digital thermometer." p. 1, 2015. [Online]. Available: <https://www.analog.com/media/en/technical-documentation/data-sheets/ds18b20.pdf>
- [22] "Gravity: analog dissolved oxygen sensor SKU: SEN0237." [Online]. Available: https://www.sigmaelectronics.net/wp-content/uploads/2018/04/Gravity_-Analog-Dissolved-Oxygen-Sensor-SKU_SEN0237-DFRobot-Electronic-Product-Wiki-and-Tutorial_-Arduino-and-Robot-Wiki-DFRobot.com_.pdf
- [23] B. Satria, "IoT monitoring suhu dan kelembaban udara dengan nodeMCU ESP8266," *Sudo Jurnal Teknik Informatika*, vol. 1, no. 3, pp. 136–144, Aug. 2022, doi: 10.56211/sudo.v1i3.95.
- [24] I. R. Mardhiya, A. Surtono, and S. W. Suciayati, "Sistem akuisisi data pengukuran kadar oksigen terlarut pada air tambak udang menggunakan sensor dissolve oxygen (DO)," *Jurnal Teori dan Aplikasi Fisika*, vol. 5, no. 2, pp. 133–140, 2017.
- [25] A. Sumardiono, S. Rahmat, E. Alimudin, and N. A. Ilahi, "Sistem kontrol-monitoring suhu dan kadar oksigen pada kolam budidaya ikan lele," *JTERA (Jurnal Teknologi Rekayasa)*, vol. 5, no. 2, p. 231, 2020, doi: 10.31544/jtera.v5.i2.2020.231-236.
- [26] S. Suriana, A. P. Lubis, and E. Rahayu, "Sistem monitoring jarak jauh pada suhu kolam ikan nila bangkok memanfaatkan internet of things (IOT) berbasis NODEMCUESP8266," *JUTSI (Jurnal Teknologi dan Sistem Informasi)*, vol. 1, no. 1, pp. 1–8, Sep. 2021, doi: 10.33330/jutsi.v1i1.1004.
- [27] C. Wang, Z. Li, T. Wang, X. Xu, X. Zhang, and D. Li, "Intelligent fish farm—the future of aquaculture," *Aquaculture International*, vol. 29, no. 6, pp. 2681–2711, Dec. 2021, doi: 10.1007/s10499-021-00773-8.
- [28] A. Taher Tamim *et al.*, "Development of IoT based fish monitoring system for aquaculture," *Intelligent Automation & Soft Computing*, vol. 32, no. 1, pp. 55–71, 2022, doi: 10.32604/iasc.2022.021559.
- [29] S. H. Loh, P. C. Teh, G. Y. Goay, and J. J. Sim, "Development of an IoT-based fish farm monitoring system," in *2023 IEEE 13th International Conference on Control System, Computing and Engineering (ICCSCCE)*, IEEE, Aug. 2023, pp. 281–286. doi: 10.1109/ICCSCCE58721.2023.10237168.
- [30] A. C. Subrata, T. Sutikno, S. Sunardi, A. Pamungkas, W. Arsadiando, and A. R. Cahya Baswara, "A laboratory scale IoT-based measuring of the solar photovoltaic parameters," *International Journal of Reconfigurable and Embedded Systems (IJRES)*, vol. 11, no. 2, p. 135, Jul. 2022, doi: 10.11591/ijres.v11.i2.pp135-145.

BIOGRAPHIES OF AUTHORS





Nurma Sari    received the bachelor's degree in physics (1996) from University of Diponegoro (UNDIP) and a masters degree in physics (2007) specializing in waveguide antenna from Institut Teknologi Sepuluh Nopember (ITS). She received doctoral degree in physics (2022) at Institut Teknologi Sepuluh Nopember (ITS), Indonesia, funded by BUDI-DN LPDP Indonesia. Her interdisciplinary research interests focus on applying physics, applying electromagnetics, applying optics, and waveguide antenna. She can be contacted at email: nurmasari01@ulm.ac.id.







Yuniar Savitri    was born in Banjarmasin in 2001. Her educational history went to MIN Langkai Palangkaraya, MTsN 1 Model Palangkaraya, MAN Kota Palangkaraya (2019), and completed his studies in the bachelor's degree in physics (2023) in the field of instrumentation at the University of Lambung Mangkurat. His research interests focus on electronics and instrumentation of physics. She can be contacted at email: yuniarsavitri147@gmail.com.







Sri Cahyo Wahyono    received the bachelor's degree in physics (1997) from University of Diponegoro (UNDIP) and a masters degree in physics (2004) specializing in waveguide antenna from Institut Teknologi Sepuluh Nopember (ITS), Indonesia, funded by DIKTI Indonesia. His interdisciplinary research interests focus on applying physics and geophysics. He can be contacted at email: sewahyono@ulm.ac.id.

Commented [pq4]: Inaccessible author orcid link (This ORCID Record is locked), ensure link can be accessed



Joko Santoso     received the bachelor's degree in physics (2019) from University of Lambung Mangkurat (ULM). He is currently a technician in instrumentation and computational physics laboratories at University of Lambung Mangkurat, Indonesia. He can be contacted at email: jokosantoso1507@gmail.com.



Amar Vijai Nasrulloh     received an undergraduate degree in physics (2004) from Institut Teknologi Sepuluh Nopember (ITS) and a masters degree in electrical engineering (2010) specializing in biomedical engineering from Institut Teknologi Bandung (ITB) and a Ph.D. degree in bioimage informatics from Durham University, UK, funded by LPDP Indonesia. He is currently a lecturer in physics study program at University of Lambung Mangkurat, Indonesia. His interdisciplinary research interests focus on applying physics and image processing methods to biology and medicine. He can be contacted at email: amarvijai01@ulm.ac.id.

Design of IoT-based monitoring system for temperature and dissolved oxygen levels in catfish aquaculture pond water

Nurma Sari, Yuniar Savitri, Sri Cahyo Wahyono, Joko Santoso, Amar Vijai Nasrulloh
Physics Study Program, University of Lambung Mangkurat, Banjarbaru, Indonesia

Article Info	ABSTRACT
<p>Article history:</p> <p>Received Jul 20, 2023 Revised Oct 26, 2023 Accepted Jan 15, 2024</p> <hr/> <p>Keywords:</p> <p>Catfish aquaculture pond Dissolved oxygen levels Internet of things-based NodeMCU ESP8266 Temperature</p>	<p>One of the fish in Indonesian waters that has been successfully bred and cultivated is the catfish (<i>Pangasius sp.</i>). In catfish farming, there are several water quality factors that need to be considered, such as temperature and dissolved oxygen levels. Based on the existing description, it is very important to pay attention to the water quality of aquaculture ponds, especially temperature and dissolved oxygen levels for fish survival. This study aims to create an internet of things (IoT) based monitoring system for temperature and dissolved oxygen levels in catfish aquaculture pond water based on NodeMCU ESP8266. Monitoring system is using SEN0237 gravity analog dissolved oxygen sensor, DS18B20 sensor module, NodeMCU ESP8266, 20x4 character liquid-crystal display (LCD), micro secure digital (SD) card module, internet modem. Data from measurements of temperature and dissolved oxygen levels are stored online in the Adafruit.io database in the .csv format and on a micro SD card in the device in the .txt format. The lowest value of dissolved oxygen levels and temperature are 3.4 mg/L or 3.4 ppm and a temperature of 27.9 °C, respectively. Meanwhile, the highest value of dissolved oxygen levels and temperature are 4.6 mg/L or 4.6 ppm and temperature of 30.9 °C, respectively. During the 3 days measurement, the lowest value of dissolved oxygen levels and temperature are 3.4 mg/L or 3.4 ppm and a temperature of 27.9 °C, respectively. Meanwhile, the highest value of dissolved oxygen levels and temperature are 4.6 mg/L or 4.6 ppm and temperature of 30.9 °C, respectively.]</p> <p><i>This is an open access article under the CC BY-SA license.</i></p> 

Commented [I1]: Your abstract is too long, it's better to shorten it again into max. 200 words

Commented [LV2R1]: The abstract has been adjusted to 200 words

Corresponding Author:

Nurma Sari
Physics Study Program, University of Lambung Mangkurat
70714, Banjarbaru, Kalimantan Selatan, Indonesia
Email: nurmasari01@ulm.ac.id

1. INTRODUCTION

Catfish is one of the native fish in Indonesian waters that grows well. Catfish is a freshwater fish that belongs to the catfish (*Pangasius sp.*) type. Pangasidae can be mass-produced and offers the potential for industrial-scale development due to its basic characteristics of lacking scales, having few spines, having a fairly fast growth rate, and having high fertility and survival rates. With all these benefits, this fish has increased economic value among fishery commodities, both in the hatchery and grow-out business sectors [1], [2]. In recent times, real time water quality monitoring in aquaculture has been brought by the fast development of internet of things (IoT) technology effectively. Globally, water quality monitoring systems based on IoT and wireless communication technologies have been widely studied intensively [3]–[6], [7]–[13].

Dissolved oxygen levels are one of the water quality parameters that can cause large numbers of fish to die. The processes of decomposition, reproduction and development in ponds are hampered by low dissolved oxygen levels. According to Indonesian National Standard (SNI) number 01-6483.3-2000 for

catfish culture, dissolved oxygen levels range from >4 mg/L. The need for fish for dissolved oxygen levels depends on the age of the fish, fish activity, and water quality [14]. Dissolved oxygen levels in ponds vary from time to time. Research show that dissolved oxygen levels change due to the influence of changing temperatures due to unstable weather [15]. According to Dong et al [16], dissolved oxygen levels for fisheries must be at least 5 mg/L. If the concentration of dissolved oxygen is not balanced, the fish will be stressed because the brain does not get enough oxygen. Fish will experience anoxia because their body tissues are unable to bind dissolved oxygen in the blood.

The water temperature of fish farming ponds is an important factor. The ideal temperature tolerance range for catfish according to SNI number 01-6483.3-2000 is between 25-30 °C. Pool water temperature affects water quality [17]. Oxygen solubility is one of the characteristics of water quality that is affected by temperature variations. With increasing temperature, the level of solubility of oxygen decreases [18], [19]. Once there is an increase in temperature, the amount of solubility of oxygen in water will decrease. An increase in temperature causes the metabolic activity of fish to be greater which results in a doubling of oxygen consumption in fish. Low water temperature can affect the ability of fish to bind oxygen so that it can inhibit fish development [20]. Fish that experience stress reduce stamina and reduce hunger, and eventually starve to death [16].

The DS18B20 temperature sensor is a device that can read temperature variations and then translate these changes into electrical quantities. This sensor is connected to the microcontroller using a single cable and is a digital sensor. These sensors are special because each sensor contains a serial code that allows the use of multiple DS18B20s in one-wire transmission. This sensor can be used with 3.0 to 5.5 V. The sensor has ± 0.5 °C accuracy from -10 to +85 °C and can be used in the temperature range of -55 to 125 °C (-67 to +257 °F) with a resolution of 9 to 12 bits [21]. SEN0237 gravity analog dissolved oxygen sensor is a sensor for measuring dissolved oxygen levels in water. These sensors are widely used in various water-related sectors, including research, aquaculture, and monitoring of the aquatic environment. This sensor is open source and compatible with various microcontrollers, allowing users to use it freely and openly. This sensor has a galvanic probe type with a detection range of 0 to 20 mg/L. This sensor has a response time of up to 98% full response, within 90 seconds (25 °C) sensor pressure range from 0 to 50 PSI with electrode service life generally for 1 year for normal use [22]. NodeMCU ESP8266 is a microcontroller equipped with the ESP8266 chip. This microcontroller has multiple input or output ports to enable monitoring and control applications for IoT projects. The NodeMCU ESP8266 is an evolution of the ESP8266 version of the ESP-12 IoT platform module family. This module works very similarly to the Arduino module platform in terms of functionality, but the difference is "connected to the internet" [23].

Several studies that have been conducted regarding the measurement of water quality in aquaculture ponds. For instance, Moreno-Rodenas *et al.* [24] in 2017 was working on a data acquisition system for measuring dissolved oxygen levels with the results that the average dissolved oxygen level is in the range of 3 to 5 mg/L in rainy conditions and between 3 to 7 mg/L on cloudy conditions. Next, research by Kustija and Andika [25] in 2021, was showing a system for monitoring temperature and dissolved oxygen levels in catfish ponds with the Raspberry Pi that was obtained the water temperature varied with time. Furthermore, research by Bima *et al.* [26] in 2018 built a temperature remote monitoring system in Bangkok tilapia ponds, the effective temperature for fish pond water was an indicator of 28 to 30 °C. To fill the needs of fish consumes, aquaculture methods have been forced to overproduce and resulting in the accelerated water environment degradation and the old of agricultural workers in many parts of the world so will face the dilemma of shortage of labor, and IoT aquaculture method is one of the method that can resolve the issue [27]. Fish farming has been applied widely recently. In Bangladesh, fish monitoring had been studied based on IoT so it notified the user the amount of dissolved oxygen, ammonia level, pH level, and water body temperature. It can help fish farmers to measure the parameters and provide necessary things to grow more fish and facing water pollution [28]. Latest research by Loh *et al.* [29] showed that to address the challenges of maintaining aquatic environment, IoT fish farm monitoring system has been done to provide several features such as temperature, pH, dissolved oxygen, total dissolved solid, and energy usage of the water pump.

Erratic weather patterns cause poor water quality for fish farming, which makes fish susceptible to disease and if it continues will result in mass fish mortality. Based on the existing description, it is very important to pay attention to the water quality of aquaculture ponds, especially temperature and dissolved oxygen levels for fish survival. In this research, a remote and IoT based monitoring system for temperature and dissolved oxygen levels in catfish farming ponds will be made using the DS18B20 and SEN0237 gravity analog dissolved oxygen sensor internet-based sensors which will be tested and implemented in catfish farming ponds. This monitoring system uses NodeMCU ESP8266 as a microcontroller and Adafruit.io as an online interface. By applying IoT technology with an internet network, this up-to-date technology is able to send data and offer speed and a vast distance [30]. This research develops IoT technology for sending

parameter data from dissolved oxygen level and temperature directly to a web server. Then, the stored data for 24 hours on the webserver can be processed for further identification all the time.

2. RESEARCH METHOD

2.1. Material

The materials used are the sensor modules which are DS18B20 temperature sensor and SEN0237 gravity analog dissolved oxygen sensor. Next is the microcontroller kit that consists of NodeMCU ESP8266, 20×4 character liquid-crystal display (LCD) with inter-integrated circuit (I2C) and secure digital (SD) card module. It is also supported by 12 V 2 A adapter, step down DC to DC converter, tin, electronic components, connecting cables, and control panel box.

2.2. Method

2.2.1. Hardware

The proposed of the NodeMCU ESP8266-based IoT monitoring system for temperature and dissolved oxygen consists of several stages starting with preparing the tools and materials needed in this research (Figure 1). It proceeds with assembling the hardware, namely integrating the NodeMCU ESP8266 with the sensor, and assembling a remote monitoring system for temperature and dissolved oxygen based on the NodeMCU ESP8266. Furthermore, the manufacture of software includes the manufacture of microcontroller software, manufacture of LCD interface software and manufacture of IoT software. Followed by determining the transfer function of measuring instruments, testing the system as a whole and finally data collection. The details of the proposed system can be seen clearly in Figure 1(a). Meanwhile, Figure 1(b) shows layout of the circuit design of remote monitoring of temperature and dissolved oxygen levels based on Node MCU ESP8266. It is included SEN0237 analog dissolved oxygen sensor, DS18B20 sensor, SD Card module, and 20×4 characters I2C LCD module are integrated into the NodeMCU ESP8266.

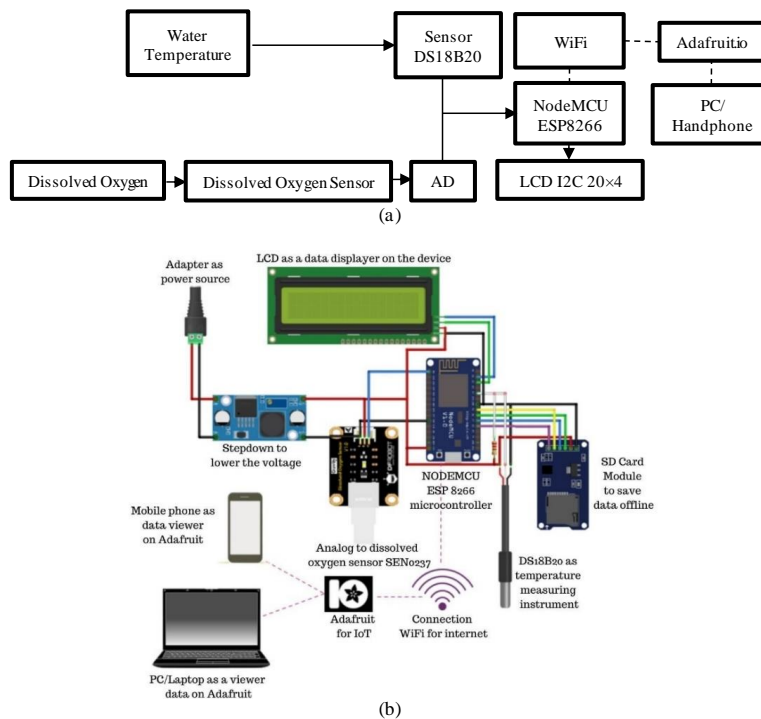

Figure 1. Proposed system of (a) block diagram and (b) circuit design

2.2.2. Software

Figure 2 shows the function of NodeMCU ESP8266 for both with sensors and LCD and also with IoT. The software on NodeMCU ESP8266 is made using the Arduino IDE software. The software interface to LCD using Arduino IDE software that connecting between NodeMCU ESP8266 and sensors (DS18B20 dan SEN0237 analog dissolved oxygen sensor). The stages include LCD pin configuration, library input, and giving commands to retrieve data from the output of the measuring instrument circuit. The flowchart of the programme interface to display characters on the LCD can be seen in Figure 2(a).

Calibration was accomplished by comparing the measured value on the sensor with the measured value on a standard measuring instrument. For the DS18B20 sensor, a digital thermometer is used as a comparison. The measurement range used is 10 to 50 °C. Meanwhile, for the SEN0237 grativity analog dissolved oxygen sensor, a dissolved oxygen meter is used as a comparison. Measurements were made using zero dissolved oxygen powder which was added little by little until a measured dissolved oxygen value of 0 mg/L was obtained.

Figure 2(b) presents connection of NodeMCU ESP8266 with IoT. The system developed by the Arduino IDE software and the IoT interface used Adafruit.io. In details, to connect NodeMCU ESP8266 with IoT, it is mandatory to write down the wifi name and password of the wifi used. To link readings to Adafruit.io, the listing should include the Adafruit.io web address, the username of the Adafruit.io account used, the active key, and the name of the feed used. The monitoring system that is made is tested first by observing each part whether it is working properly. Next, a performance check of the NodeMCU ESP8266 is carried out by connecting to the internet so that it reads Adafruit.io. After connected to the internet and a notification appears that Adafruit.io has been connected, a comparing the values between on the LCD of the device and Adafruit.io. Once the reading value of the measuring instrument that appears is appropriate, the tool can be used.

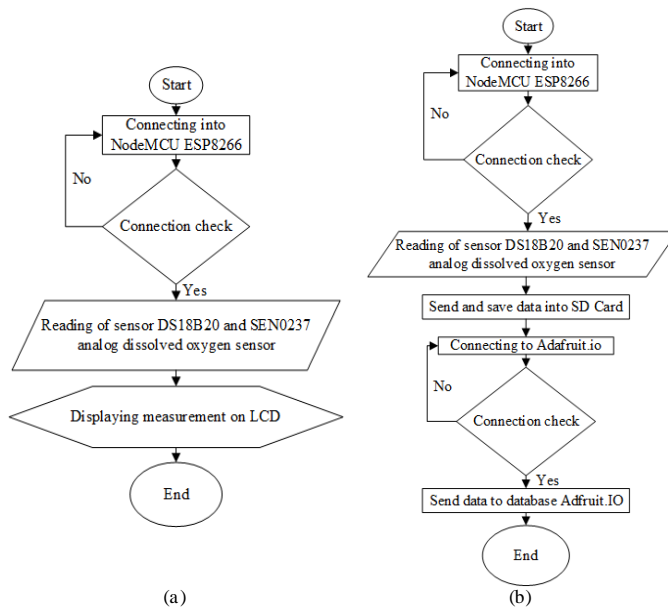

Figure 2. Flowchart of NodeMCU ESP8266 with (a) sensors and LCD and (b) IoT

Calibration was accomplished by comparing the measured value on the sensor with the measured value on a standard measuring instrument. For the DS18B20 sensor, a digital thermometer is used as a comparison. The measurement range used is 10 to 50 °C with the sensor readings obtained, the (1) is obtained.

$$y = 1,0129x + 0,2557 \text{ with } R^2 = 1 \quad (1)$$

The (1) is then entered into the Arduino program. It is intended that the readings from the DS18B20 sensor are the same as standard measuring instruments. After the equation is entered into the Arduino program, retesting is carried out with a temperature range of 20 to 35 °C as a representative of the reasonable limit for measuring catfish pond water. Data on the results of retesting the DS18B20 sensor can be seen in Table 1. Meanwhile, for the SEN0237 gravimetric analog dissolved oxygen sensor, a dissolved oxygen meter is used as a comparison. Measurements were made using zero dissolved oxygen powder which was added little by little until a measured dissolved oxygen value of 0 mg/L was obtained. Based on the sensor readings obtained, the (2) is obtained.

$$y = 126,22x - 129,85 \text{ with } R^2 = 0,9664 \quad (2)$$

The (2) is then entered into the Arduino program. This aims to convert the reading from SEN0237 analog dissolved oxygen sensor into mg/L like the reading from dissolved oxygen meter. After the equation is entered into the Arduino program, a retest is carried out using PDAM water with calibration powder added little by little until the dissolved oxygen level in local government-owned water utility (PDAM) water becomes 0 mg/L. The data of SEN0237 analog dissolved oxygen sensor retest can be seen in Table 2.

Table 1. DS18B20 sensor retest result data

No	Calibrator (\bar{x})	DS18B20 sensor (\bar{x}_i)	Difference ($\bar{x}-\bar{x}_i$)	Error (%)
1	20	20	0	0.00
2	21	21.02	-0.02	0.10
3	22	22.03	-0.03	0.14
4	23	23.04	-0.04	0.17
5	24	23.99	0.01	0.04
6	25	25.00	0.00	0.00
7	26	26.02	-0.02	0.08
8	27	27.03	-0.03	0.11
9	28	28.04	-0.04	0.14
10	29	28.99	0.01	0.03
11	30	30.01	-0.01	0.03
12	31	31.02	-0.02	0.06
13	32	32.03	-0.03	0.09
14	33	33.04	-0.04	0.12
15	34	34.06	-0.06	0.18
16	35	35.01	-0.01	0.03
Error mean				0.1

Table 2. Result of the retest data on SEN0237 analog dissolved oxygen sensor

No	Calibrator (\bar{x})	SEN0237 sensor (\bar{x}_i)	Difference ($\bar{x}-\bar{x}_i$)	Error (%)
1	6.50	6.82	-0.32	4.92
2	6.03	6.57	-0.54	8.9
3	5.90	6.07	-0.17	2.82
4	5.70	5.58	0.12	2.05
5	5.27	5.18	0.09	1.71
6	4.53	4.35	0.18	4.12
7	3.80	3.09	0.71	18.77
8	2.53	1.75	0.78	31.05
Error mean				9.3

2.2.3. System realization

Figures 3 show the location and configuration of the equipment and its placement in the catfish farming pond. Pre-data collection was retrieved for 2 days to determine the readiness of the tool before the actual data collection was carried out. Pre-data collection was carried out during weather conditions after rain and in ponds with cloudy weather conditions accompanied by rain. Data monitoring can be monitored via mobile phones and laptops or other devices that can access the internet. To monitor the measurement results via the internet, users can open the link that has been provided for this monitoring system. Measurements will begin when the NodeMCU ESP8266 microcontroller is connected to the internet. The process of connecting the microcontroller to the internet takes ± 40 seconds depending on the speed of internet access. The better the internet network used, the faster the microcontroller is connected. If the internet network is disconnected, the data displayed is the last data before the network is disconnected. This monitoring system has a weakness in

the dissolved oxygen sensor used, which is a probe filling solution sensor that must always be monitored. During the pre-take, it is known that the effective use of the probe filling solution is about 3-4 hours. Therefore, every 3-4 hours it is necessary to check and replace the probe filling solution so that the measurement results obtained have a good value. The probe filling solution used should always be in good condition and no bubbles should form on the filling membrane. The formation of bubbles and poor probe filling solution can affect the measurement results.

Location of the ponds in this research can be clearly seen in Figure 3(a). The laying tools in the field using a box that is given a hole and then associated with a paralon pipe tied to the bridge. The tool box, modem, and power outlet (Figure 3(b)) are placed in a green box which is then given a hole for the sensor probe. The sensor probe is connected to the outside of the box and then inserted into the paralon pipe that has been tied to the bridge to prevent the position of the probe from moving if it is hit by a fish that has an impact on the measurement (Figure 3(c)).

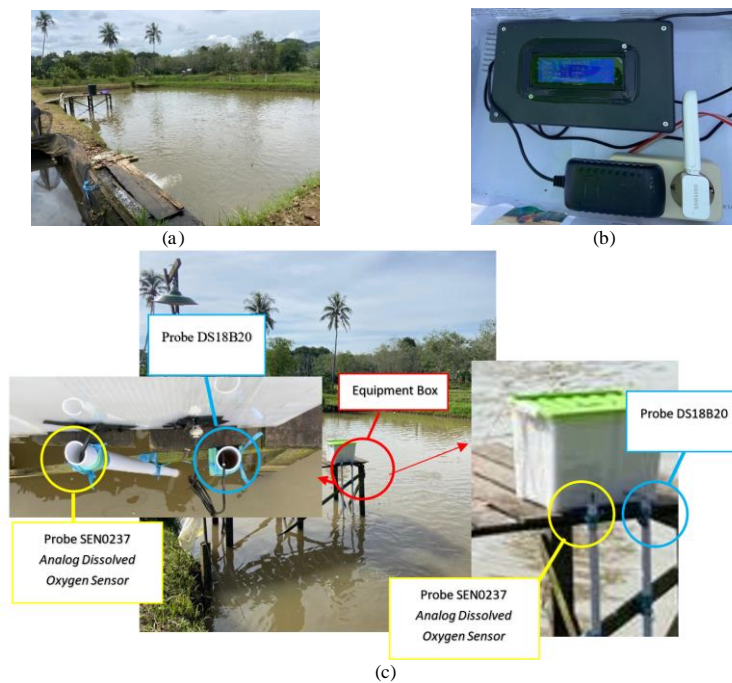

Figure 3. The location and configuration of the equipment and its placement in the catfish farming pond by (a) location of catfish ponds where data is collected, (b) measurement and IoT system processing equipment, and (c) IoT based monitoring system for temperature and dissolved oxygen levels in catfish farming ponds

3. RESULTS AND DISCUSSION

The calibration process of the SEN0237 analog dissolved oxygen sensor. Measurements were carried out three times using water mixed with zero dissolved oxygen powder until the dissolved oxygen level in the water was 0 mg/L. Based on the results of the sensor readings obtained the regression formula in (2) and adapted into Arduino program. From the results of retesting conducted, it is known that the average error in sensor readings is 9.3% (Table 2). Meanwhile, based on the results of the DS18B20 temperature sensor during calibration, it is obtained the regression formula in (1). This equation is then adapted into the Arduino program. It is intended that the readings from the DS18B20 sensor are the same as standard

measuring instruments. From the results of retesting, it is known that the average error value of reading is 0.1% (Table 1).

The readings that appear on the [Adafruit IO](#) dashboard are temperature, dissolved oxygen (mg/L), and dissolved oxygen (ppm) in the form of images and gauges. Figure 4 is the interface display on [Adafruit IO](#). The gauge is given a limit value, where if the dissolved oxygen value is below 4 mg/L or 4 ppm and the temperature is below 25 °C and more than 30 °C then the gauge will turn red as a sign that the measurement was carried out in a condition that is not in accordance with SNI number 01-6483.3-2000. Meanwhile, when the measurement results are >4 mg/L or 4 ppm for dissolved oxygen and the temperature is around 25-30 °C, the gauge will turn green. Data display indicators for monitoring can be said to be real-time if the interface for sensor readings that appear on the LCD and the Adafruit.io dashboard is "same". Figure 5 shows the real-time readings of the Adafruit.io LCD and dashboard.

Commented [I3]: Adafruit.io?
Commented [LV4R3]: Adafruit IO is a platform designed to respond and display desired data

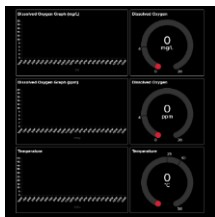

Figure 4. Adafruit.io display developed Figure 5. Testing and validating of the IoT-based system

Data measurement from the downloaded of Adafruit.io database is in .csv file format, while stored on the micro SD card is in the .txt file format (Figure 6). Data stored in the Adafruit.io database can be downloaded in .csv file format for each feed (Figure 6(a)). Along side stored online in the Adafruit.io database, measurement data is also stored offline on a micro SD card in the form of a .txt file. The stored data contains time data, SEN0237 analog dissolved oxygen sensor readings in mg/L and ppm units, as well as DS18B20 sensor module readings which are separated by commas “,”. This data can be converted into an spreadsheet table for comparative image analysis. Figure 6(b) shows the .txt file data written to and stored on the micro SD card.

	A	B	C	D	E	F	G	H
1	id,value,feed_id,created_at,lat,lon,ele							
2	0F8ZMTEB5P0V2G3B9WNSPJRBTG,1.03,2490571,2023-03-30 05:29:32 UTC...							
3	0F8ZMFXRQZ7LRSD2819HWMBP4,1.03,2490571,2023-03-30 05:29:42 UTC...							
4	0F8ZMZD07XMECCG56Z27G1K1,1.03,2490571,2023-03-30 05:29:52 UTC...							
5	0F8ZMZG3W6J1VXYRE03KHPVRL1,1.03,2490571,2023-03-30 05:30:02 UTC...							
6	0F8ZM2K6SR0CQ08P81KCD04H,1.03,2490571,2023-03-30 05:30:13 UTC...							
7	0F8ZM2N4MYTEV7P9VCVQ0G8H,1.03,2490571,2023-03-30 05:30:23 UTC...							
8	0F8ZM2C0THW030T3QVFW3F2C,1.03,2490571,2023-03-30 05:30:33 UTC...							
9	0F8ZM2F28NG7W7Q6YMSC29Q68,1.03,2490571,2023-03-30 05:30:43 UTC...							
10	0F8ZMZWSG7767G9HRJ26QVZ16,1.03,2490571,2023-03-30 05:30:53 UTC...							
11	0F8ZM2QZ7FKRUT758N890J09,1.03,2490571,2023-03-30 05:31:07 UTC...							
12	0F8ZM2C6W112W6A47NGL3H,1.03,2490571,2023-03-30 05:31:14 UTC...							
13	0F8ZM2W8XFG81204HKCEKAX39,1.03,2490571,2023-03-30 05:31:24 UTC...							
14	0F8ZM2ZCRTJ0T7X7Q422E6S6A,1.03,2490571,2023-03-30 05:31:34 UTC...							
15	0F8ZM2G2QNNQ7VFN9YB182,1.03,2490571,2023-03-30 05:31:44 UTC...							
16	0F8ZM2K5EF902MPPAN9GH38R0,1.03,2490571,2023-03-30 05:31:54 UTC...							
17	0F8ZM2N808G0P713W4W4DAM2K8E,1.03,2490571,2023-03-30 05:32:05 UTC...							
18	0F8ZM2N808G0P713W4W4DAM2K8E,1.03,2490571,2023-03-30 05:32:15 UTC...							
19	0F8ZM2K5EF902MPPAN9GH38R0,1.03,2490571,2023-03-30 05:32:25 UTC...							
20	0F8ZM2J07TEP5153C87WY2HC,1.03,2490571,2023-03-30 05:32:35 UTC...							
21	0F8ZM2N41RY9Z8N31V4Z2CT0T,1.03,2490571,2023-03-30 05:32:45 UTC...							

(a)

File	Edit	View
Maktu,Dissolved Oxygen (mg/L),Maktu,Dissolved Oxygen (ppm),		
07:27:19,2.55,2.55,26.91		
07:27:30,2.50,2.50,27.73		
07:27:40,2.55,2.55,27.67		
07:27:50,2.47,2.48,27.67		
07:28:00,2.52,2.52,27.67		
07:28:10,27.37,27.40,27.67		
07:28:21,8.79,8.80,27.60		
07:28:31,7.84,7.85,27.54		
07:28:41,7.48,7.49,27.35		
07:28:51,7.48,7.49,27.16		
07:29:01,7.05,7.05,27.35		
07:29:12,4.95,4.96,27.22		
07:29:22,3.96,3.96,27.79		
07:29:32,3.50,3.50,27.79		
07:29:42,3.52,3.52,27.86		
07:29:52,3.39,3.40,-128.38		
07:30:03,3.39,3.40,27.86		
07:32:53,3.50,3.50,27.86		
07:34:34,3.27,3.27,27.86		
07:34:44,3.34,3.34,27.86		
07:37:06,3.29,3.29,27.86		

(b)

Figure 6. Display of measurement results data of (a) the downloaded from the Adafruit.io database in .csv file format and (b) the .txt file data written to and stored on the micro SD card

Data collection was retrieved for three days (Figure 7). The measuring instrument is placed on a bridge with a height of ±80 cm from the water surface with the sensor probe submerged about 2-4 cm from the water surface. During data collection, the weather is constantly changing. Data collection on first day was

in cloudy weather conditions accompanied by rain during the day. The relationship between temperature and dissolved oxygen levels from data collection on the first day can be seen in Figure 7(a). From the figure it is known that when the temperature increases the dissolved oxygen levels decrease and vice versa. From the Figure 7(a), the relationship between temperature and dissolved oxygen levels is most clearly seen at point a at 13:15, where the dissolved oxygen value reaches 4.5 mg/L or 4.5 ppm with a measured temperature of 28.6 °C. It also shows a decrease in dissolved oxygen values and temperature due to rain during the day, from 13:15 to 14:30. Apart from when it rains, dissolved oxygen values and measured temperatures also tend to decrease at night at 19:15. The dissolved oxygen value measured after rain and at night fell below 4 mg/L.

Data collection on second day was cloudy in the morning, then hot during the day and cloudy again in the late afternoon. Figure 7(b) is a graph of the relationship between temperature and dissolved oxygen levels. From the Figure 7(b) it is known that when the temperature increases the dissolved oxygen level decreases and vice versa as seen at 19:30 to 20:00. In some conditions there are temperature values that are not in accordance with the theory, such as at points d to e where the temperature values measured exceed the value of 30 °C at 13:00 to 17:30 caused by the hot sun during the day. The dissolved oxygen value between 10:00 and 11:30 is measured to be less than 4 mg/L in the morning with cloudy weather conditions after rain. The low dissolved oxygen value measured is the dissolved oxygen value measured at the time of changing the probe filling solution because when changing the probe is removed from the water. The low dissolved oxygen measured, aside from the effect of temperature, is also caused by other factors such as the water level and the water content.

Data collection on third day in sunny weather conditions in the morning then hot during the day, cloudy in the late afternoon accompanied by rain at night. Figure 7(c) is a graph of the relationship between temperature and dissolved oxygen levels. The Figure 7(c) during the temperature increases the dissolved oxygen levels decrease and vice versa. The relationship between temperature and dissolved oxygen can be seen at 15:45 to 17:15 once dissolved oxygen increases the temperature value decreases. In some conditions there are temperature values measured outside the limits of SNI provisions at 11:30 to 16:30 with the measured values are more than 30 °C. This condition occurs due to the hot weather during the day that causes the temperature to increase. Dissolved oxygen values that were measured outside the regulatory limits were seen between 10:00 and 10:45 and at 17:15 to 20:00, where dissolved oxygen values were measured below 4 mg/L. The low dissolved oxygen measured apart from temperature is also caused by other factors such as water level and water content. From the data image, the most obvious one is at 14:00 where the dissolved oxygen value reaches 4.2 mg/L or 4.2 ppm with a measured temperature of 30.9 °C.

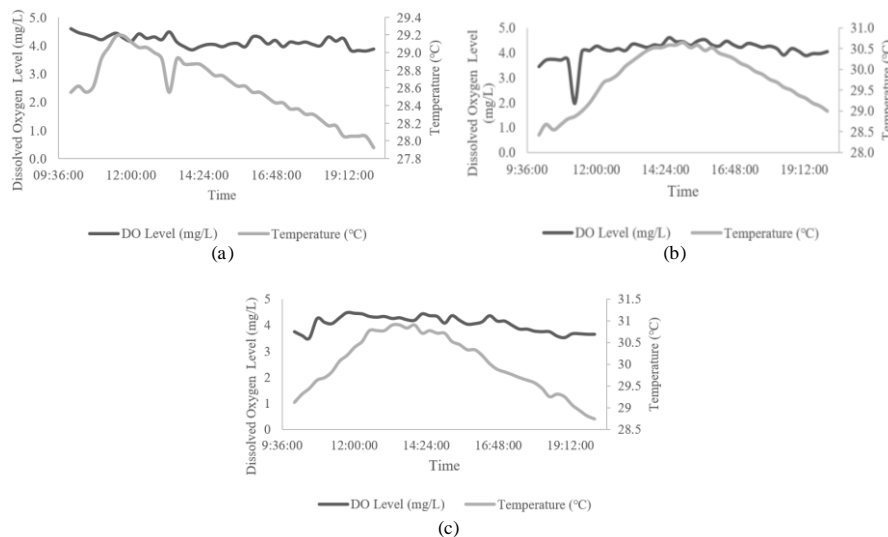

Figure 7. Data collection of dissolved oxygen level (black line) and temperature (gray line) for three days (a) first day, (b) second day, and (c) third day data collection

Based on measurements carried out for three days, from 10:00 to 20:00 (Table 3), it is known that the temperature and dissolved oxygen values of the Karang Intan catfish pond are relatively safe and quite good. In the morning dissolved oxygen in fish pond water is quite low, then it increases as the day progresses. When it rains, the measured dissolved oxygen levels also decrease. This is similar to research conducted by Mardhiya *et al.* [31] in 2017 which obtained an average dissolved oxygen level in the range of 3 to 5 mg/L in rainy conditions and a range of 3 to 7 mg/L in cloudy conditions. Abundant oxygen levels during the day with sunny weather due to the process of respiration by macrophytes in the mechanism of photosynthesis with the help of sunlight. While at night dissolved oxygen decreased again. The decrease in dissolved oxygen levels at night is due to the absence of photosynthesis at night, also caused by the level of temperature fluctuations by the air, the increased respiration rate of sediment by bacteria and the more intense respiration rate in fish ponds by aquatic organisms. As for the temperature, it is influenced by the surrounding conditions. As the day gets darker, when the weather is cloudy and it rains, the measured temperature decreases and vice versa, when the weather is sunny and the sun is hot enough, the measured temperature increases. This is similar to research conducted by Sumardiono *et al.* [32] in 2020, for example when it is sunny the temperature will rise to around 29 °C, when it is foggy it will drop to around 27.7 °C, and at night it will generally drop to around 29.4 °C. The graph of the maximum and minimum values of dissolved oxygen and temperature measured for 3 days can be seen in Figure 8.

Table 3. Maximum and minimum values of data for three days of measurement

Day	Time	Dissolved oxygen (mg/L)			Temperature (°C)			
		Max	Time	Min	Time	Max	Min	
1	10:00:01	4.6	19:45:01	3.81	11:45:09	29.19	20:00:37	27.92
2	14:30:15	4.6	10:00:42	3.44	15:00:09	30.64	10:00:42	28.43
3	11:45:20	4.49	10:30:05	3.5	13:30:38	30.9	20:00:12	28.74

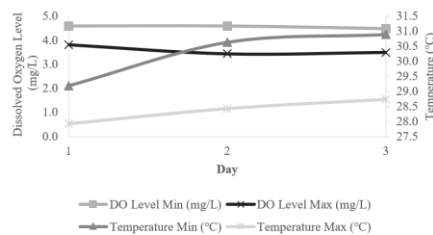

Figure 8. The maximum and minimum values of dissolved oxygen level and temperature of 3 days of measurement

In Figure 8 it can be seen that dissolved oxygen tends to be lower in the morning, then increases as the day progresses. During 3 days the measurement was carried out, the dissolved oxygen levels and temperature measured during the measurement had the lowest value of 3.44 mg/L or 3.44 ppm with a temperature of 27.92 °C and the highest value of 4.6 mg/L or 4.6 ppm with a temperature of 30.9 °C. From the measurements taken, it is known that dissolved oxygen levels have good values during the daytime, while in the morning and night have poor values. The maximum value of dissolved oxygen that was measured was obtained at 10:00, 14:30, and 11:45. At night dissolved oxygen tends to decrease, where from the data obtained it is recorded that the minimum dissolved oxygen value is at 19:45, 10:00, and 10:30. Meanwhile, the temperature tends to increase during the day and decreases in the afternoon until the evening. From the data recorded from measurements for three days, it was found that the temperature experienced a maximum value at 11:45, 15:00, and 13:30. The minimum temperature recorded is at 20:00 and 10:00. The low temperature measured in the morning is caused by temperature changes that occur at night accompanied by rain, so that when measurements are taken in the morning the measured temperature tends to be low. From the measurement data obtained, it is known that dissolved oxygen levels are indeed affected by temperature, but this factor does not have a significant effect. There are other factors that affect dissolved oxygen levels in fish pond water. Even so, the water quality measured in the catfish pond is fairly good because the dissolved oxygen and measured temperatures are still within safe limits. The circulation of fish pond water is quite good so that even though the measured dissolved oxygen was below the SNI number 01-6483.3-2000

standard for catfish cultivation, dissolved oxygen can again increase to the threshold according to SNI number 01-6483.3-2000. This system also spent a low cost for its operation. In details, for the distilled water solution as a neutralizer or rinsing probes before and after use, approximately 500 ml of distilled water is enough for one week of data collection. As for probe filling or NaOH liquid, approximately 30 ml is enough for one week of data collection. Cost calculation for 1 week, 500 ml of distilled water costs USD 0.45 and 30 ml of 0.5 molar NaOH costs USD 0.032 so the total cost for 1 week is USD 0.48. (USD 1=IDR 15,719).

4. CONCLUSION

An IoT-based monitoring system for temperature and dissolved oxygen levels in catfish farming ponds using the DS18B20 and an internet-based dissolved oxygen sensor has been successfully developed. This monitoring system are able to measure temperature and dissolved oxygen levels which have a reading error value for the DS18B20 sensor of 0.1% and for the SEN0237 analog dissolved oxygen sensor 9.3%. The effective value of the probe filling solution on the SEN0237 analog dissolved oxygen sensor is around 3-4 hours. A water quality monitoring system has been implemented in catfish pond in Karang Intan for 3 days starting from 10:00 to 20:00. From the measurements that have been made, it is obtained that the dissolved oxygen level and temperature measured during the measurement have the lowest value of 3.4 mg/L or 3.4 ppm with a temperature of 27.9 °C and the highest value of 4.6 mg/L or 4.6 ppm with a temperature of 30.9 °C. The main limitation of the dissolved oxygen sensor is the effective use of the probe filling solution is about 3-4 hours. Therefore, every 3-4 hours it is necessary to check and replace the probe filling solution. In the future, dissolved oxygen sensor replacement with longer lifetime of used for the probe filling solution replacement. This future research also using photovoltaic cells as independent energy to supply to system so it can be implemented into remote ponds that are unavailable electricity source.

REFERENCES

- [1] S. M. Limbu, 'The effects of on-farm produced feeds on growth, survival, yield and feed cost of juvenile African sharpooth catfish (*Clarias gariepinus*)', *Aquac. Fish.*, vol. 5, no. 1, pp. 58–64, 2020, doi: 10.1016/j.aaf.2019.07.002.
- [2] Y. Sukrismon, Aripriharta, N. Hidayatullah, N. Mufti, A. N. Handayani, and G. J. Horng, 'Smart Fish Pond for Economic Growing in Catfish Farming', in *Proceedings - 2019 International Conference on Computer Science, Information Technology, and Electrical Engineering, ICOMITEE 2019*, 2019, vol. 1, pp. 49–53, doi: 10.1109/ICOMITEE.2019.8921233.
- [3] D. S. Simbeye and S. F. Yang, 'Water Quality Monitoring and Control for Aquaculture Based on Wireless Sensor Networks', *J. Networks*, vol. 9, no. 4, pp. 849–849, 2014.
- [4] L. Xu, N. Wang, Y. Feng, D. Bao, and K. Jorshin, 'Design of Aquaculture System based on Wireless Monitoring and its Testing', *Int. J. Online Eng.*, vol. 10, no. 5, pp. 68–73, 2014.
- [5] L. Hongpin, L. Guanglin, P. Weifeng, S. Jie, and B. Qiuwei, 'Real-time remote monitoring system for aquaculture water quality', *Int. J. Agric. Biol. Eng.*, vol. 8, no. 6, pp. 136–143, 2015, doi: 10.3965/ijabe.20150806.1486.
- [6] C. Encinas, E. Ruiz, J. Cortez, and A. Espinoza, 'Design and implementation of a distributed IoT system for the monitoring of water quality in aquaculture', *Wirel. Telecommun. Symp.*, 2017, doi: 10.1109/WTS.2017.7943540.
- [7] M. Zhang, D. Li, L. Wang, D. Ma, and Q. Ding, 'Design and development of water quality monitoring system based on wireless sensor network in aquaculture', *IFIP Adv. Inf. Commun. Technol.*, vol. 347 AICT, no. PART 4, pp. 629–641, 2017, doi: 10.1007/978-3-642-18369-0_76.
- [8] S. Saha, R. H. Rajib, and S. Kabir, 'IoT Based Automated Fish Farm Aquaculture Monitoring System', in *2018 International Conference on Innovations in Science, Engineering and Technology, ICISSET 2018*, 2018, no. August 2019, pp. 201–206, doi: 10.1109/ICISSET.2018.8745543.
- [9] C. Dupont, P. Cousin, and S. Dupont, 'IoT for aquaculture 4.0 smart and easy-to-deploy real-time water monitoring with IoT', *IEEE*, 2018.
- [10] L. Parra, S. Sendra, L. Garcia, and J. Lloret, 'Design and deployment of low-cost sensors for monitoring the water quality and fish behavior in aquaculture tanks during the feeding process', *Sensors (Switzerland)*, vol. 18, no. 3, pp. 1–23, 2018, doi: 10.3390/s18030750.
- [11] M. Li, C. Lin, J. Ren, and F. Jiang, 'A Wireless Ecological Aquaculture Water Quality Monitoring System Based on LoRa Technology', in *Advances in Computer Science Research, International Conference on Wireless Communication, Network and Multimedia Engineering (WCNME 2019)*, 2019, vol. 89, pp. 5–7, doi: 10.2991/wcnme-19.2019.2.
- [12] F. A. Saparudin, T. C. Chee, A. S. Ab Ghafar, H. A. Majid, and N. Katiran, 'Wireless water quality monitoring system for high density aquaculture application', *Indones. J. Electr. Eng. Comput. Sci.*, vol. 13, no. 2, pp. 507–513, 2019.
- [13] L. V. Q. Danh, D. V. M. Dung, T. H. Danh, and N. C. Ngon, 'Design and deployment of an IoT-Based water quality monitoring system for aquaculture in mekong delta', *Int. J. Mech. Eng. Robot. Res.*, vol. 9, no. 8, pp. 1170–1175, 2020, doi: 10.18178/ijmerr.9.8.1170-1175.
- [14] B. Ali, A., and A. Mishra, 'Effects of dissolved oxygen concentration on freshwater fish: A review', *Int. J. Fish. Aquat. Stud.*, vol. 10, no. 4, pp. 113–127, 2022, doi: 10.22271/fish.2022.v10.i4b.2693.
- [15] G. Zdorovenova et al., 'Dissolved oxygen in a shallow ice-covered lake in winter: Effect of changes in light, thermal and ice regimes', *Water (Switzerland)*, vol. 13, no. 17, pp. 1–20, 2021, doi: 10.3390/w13172435.
- [16] X. Dong and J. G. Qin, 'Fish Adaptation To Oxygen Variations in Aquaculture From Hypoxia', *Fish. Aquac.*, vol. 2, no. March, pp. 23–28, 2019.
- [17] J. S. Lucas and P. C. Southgate, *Aquaculture: Farming aquatic animals and plants*. John Wiley & Sons, 2012.
- [18] D. A. Chin, *Water-Quality Engineering in Natural Systems*. 2006.
- [19] R. Parker, 'Review of life cycle assessment research on products derived from fisheries and aquaculture: a report for Seafish as



Commented [I5]: [1], [14],[15],[16],[23], [24], [25], [26]: We do not appreciate a local journal with local language as a reference. We strongly recommend you change this reference into another one from an international journal that uses English.

Commented [LV6R5]: We have replaced references [1], [14], [15], [16], [23], [24], [25], [26] with references from international journals.



- part of the collective action to address greenhouse gas emissions in seafood.', 2012.
- [20] C. E. Boyd and F. Lichtkoppler, *Water Quality Management in Pond Fish Culture International Center for Aquaculture Agricultural Experiment Station*, no. 22. Project: AID/DSAN-G 0039, 1979.
- [21] Datasheet DS18B20, 'Programmable Resolution 1-Wire Digital Thermometer', p. 1, 2015.
- [22] Dlnya Abdulahad Aziz, 'WebsrverBased Smart Monitoring System Using ESP8266 Node MCU Module', *Int. J. Sci. Eng. Res.*, vol. 9, no. 6, pp. 801–807, 2018.
- [23] A. Zaini, D. P. Wulandari, and R. Wulandari, 'Data Visualization on Shrimp Pond Monitoring System Based on Temperature, pH, and DO (Dissolved Oxygen) with IoT', *CENIM 2020 - Proceeding Int. Conf. Comput. Eng. Network. Intell. Multimed. 2020*, no. Cenim 2020, pp. 174–179, 2020, doi: 10.1109/CENIM51130.2020.9297851.
- [24] A. M. Moreno-Rodenas, F. Cecinati, J. Langeveld, and F. H. L. R. Clemens, 'Impact of spatiotemporal characteristics of rainfall inputs on integrated catchment dissolved oxygen simulations', *Water (Switzerland)*, vol. 9, no. 12, pp. 1–21, 2017, doi: 10.3390/w9120926.
- [25] J. Kustija and F. Andika, 'Control - Monitoring System Of Oxygen Level, Ph, Temperature And Feeding in Pond Based on Iot', *REKA ELKOMIKA J. Pengabd. Kpd. Masy.*, vol. 2, no. 1, pp. 1–10, 2021, doi: 10.26760/rekaelkomika.v2i1.1-10.
- [26] A. Bima, C. Irawan, D. A. W. Laksana, A. D. Krismawan, and F. O. Isinkaye, 'A text security evaluation based on advanced encryption standard algorithm', *J. Soft Comput. Explor.*, vol. 4, no. 4, pp. 250–261, 2023, doi: 10.52465/josce.v4i4.274.
- [27] C. Wang, Z. Li, T. Wang, X. Xu, X. Zhang, and D. Li, 'Intelligent fish farm—the future of aquaculture', *Aquac. Int.*, vol. 29, no. 6, pp. 2681–2711, 2021, doi: 10.1007/s10499-021-00773-8.
- [28] A. T. Tamim *et al.*, 'Development of IoT Based Fish Monitoring System for Aquaculture', *Intell. Autom. Soft Comput.*, vol. 32, no. 1, pp. 55–71, 2022, doi: 10.32604/IASC.2022.021559.
- [29] S. H. Loh, P. C. Teh, G. Y. Goay, and J. J. Sim, 'Development of an IoT-based Fish Farm Monitoring System', in *2023 IEEE 13th International Conference on Control System, Computing and Engineering (ICCSCE)*, 2023, pp. 281–286, doi: 10.1109/iccsce58721.2023.10237168.
- [30] A. C. Subrata, T. Sutikno, Sunardi, A. Pamungkas, W. Arsandiando, and A. R. C. Baswara, 'A laboratory scale IoT-based measuring of the solar photovoltaic parameters', *Int. J. Reconfigurable Embed. Syst.*, vol. 11, no. 2, pp. 135–145, 2022, doi: 10.11591/ijres.v11.i2.pp135-145.
- [31] I. R. Mardhiya, 'Sistem Akuisisi Data Pengukuran Kadar Oksigen Terlarut Pada Air Tambak Udang Menggunakan Sensor Dissolve Oxygen (DO)', 2017.
- [32] A. Sumardiono, S. Rahmat, E. Alimudin, and N. A. Ilahi, 'Sistem Kontrol-Monitoring Suhu dan Kadar Oksigen pada Kolam Budidaya Ikan Lele', *JTERA (Jurnal Teknol. Rekayasa)*, vol. 5, no. 2, p. 231, 2020, doi: 10.31544/jtera.v5.i2.2020.231-236.

BIOGRAPHIES OF AUTHORS





Nurma Sari    received the bachelor's degree in physics (1996) from University of Diponegoro (UNDIP) and a masters degree in physics (2007) specializing in waveguide antenna from Institut Teknologi Sepuluh Nopember (ITS). She received doctoral degree in physics (2022) at Institut Teknologi Sepuluh Nopember (ITS), Indonesia, funded by BUDI-DN LPDP Indonesia. Her interdisciplinary research interests focus on applying physics, applying electromagnetics, applying optics, and waveguide antenna. She can be contacted at email: nurmasari01@ulm.ac.id.



Yuniar Savitri    was born in Banjarmasin in 2001. Her educational history went to MIN Langkai Palangkaraya, MTsN 1 Model Palangkaraya, MAN Kota Palangkaraya (2019), and completed his studies in the bachelor's degree in physics (2023) in the field of instrumentation at the University of Lambung Mangkurat. His research interests focus on electronics and instrumentation of physics. She can be contacted at email: yuniarsavitri147@gmail.com.







Sri Cahyo Wahyono    received the bachelor's degree in physics (1997) from University of Diponegoro (UNDIP) and a masters degree in physics (2004) specializing in waveguide antenna from Institut Teknologi Sepuluh Nopember (ITS), Indonesia, funded by DIKTI Indonesia. His interdisciplinary research interests focus on applying physics and geophysics. He can be contacted at email: scwahyono@ulm.ac.id.





Commented [pq7]: Inaccessible author orcid link (This ORCID Record is locked), ensure link can be accessed

Commented [LV8R7]: The author's orcid link is now accessible



Joko Santoso     received the bachelor's degree in physics (2019) from University of Lambung Mangkurat (ULM). He is currently a technician in instrumentation and computational physics laboratories at University of Lambung Mangkurat, Indonesia. He can be contacted at email: jokosantoso1507@gmail.com.



Amar Vijai Nasrulloh     received an undergraduate degree in physics (2004) from Institut Teknologi Sepuluh Nopember (ITS) and a masters degree in electrical engineering (2010) specializing in biomedical engineering from Institut Teknologi Bandung (ITB) and a Ph.D. degree in bioimage informatics from Durham University, UK, funded by LPDP Indonesia. He is currently a lecturer in physics study program at University of Lambung Mangkurat, Indonesia. His interdisciplinary research interests focus on applying physics and image processing methods to biology and medicine. He can be contacted at email: amarvijai01@ulm.ac.id.

UNIVERSITAS
LAMBUNG MANGKURAT

Nurma Sari <nurmasari01@ulm.ac.id>

[IJRES] #PROOFREAD paper ID: 21040, final stages before publication

3 messages

IJRES Editorial Office <ijres@iaescore.com>

Thu, Jun 20, 2024 at 10:51 AM

To: nurmasari01@ulm.ac.id

Cc: yuniarsavitri147@gmail.com, scwahyono@ulm.ac.id, jokosantoso1507@gmail.com, amarvijai01@ulm.ac.id

Dear Authors,

I'm Nandar, an IJRES editorial staff.

I am here to inform you that your paper is in the final stages before publication in a November 2024 issue of the International Journal of Reconfigurable and Embedded Systems (IJRES).

I have checked the revision you submitted. Please find the attached camera-ready paper in PDF file format.

The following article will be published, please let me know if all is well with the layout.

Please read and check your paper carefully if there are any additional typos/corrections/revisions in the title, author name, email, affiliation, contract number in the acknowledgment, citation name, and full name of the abbreviation.

Please mark and put your comments in the attached file below.

Please resubmit your feedback within 2 x 24 hours, if you do not reply then the article is declared fixed.

Your cooperation in correcting your paper is required. Thank you.

Healthy regards,

Mohamad Arif Munandar

On behalf of the Editor-in-Chief

Assoc. Prof. Dr. Selvakumar Manickam

Please note:**Authors are unable to edit content, title, keywords, references, order of author names, and corresponding authors, except for typos****19 21040 IJRES 15Jan24 Rev26Oct23 (Ed II) pra pu.pdf**

864K

Amar V N <amarvijai01@ulm.ac.id>

Thu, Jun 20, 2024 at 10:56 AM

To: IJRES Editorial Office <ijres@iaescore.com>

Cc: nurmasari01@ulm.ac.id, yuniarsavitri147@gmail.com, scwahyono@ulm.ac.id, jokosantoso1507@gmail.com

Yes, everything is fine.

[Quoted text hidden]

IJRES Editorial Office <ijres@iaescore.com>

Thu, Jun 20, 2024 at 12:03 PM

To: Amar V N <amarvijai01@ulm.ac.id>

Cc: nurmasari01@ulm.ac.id, yuniarsavitri147@gmail.com, scwahyono@ulm.ac.id, jokosantoso1507@gmail.com

Dear Authors,

Thank you for reading and checking your paper carefully.

We will continue to process the publication of your paper as soon as possible.

Your cooperation in checking and/or updating your paper is required. Thank you.

Kind Regards,

Mohamad Arif Munandar

Layout and Editing Team, IJRES

Editorial Staff on behalf of the Editor-in-Chief

[Quoted text hidden]

Design of IoT-based monitoring system for temperature and dissolved oxygen levels in catfish aquaculture pond water

Nurma Sari, Yuniar Savitri, Sri Cahyo Wahyono, Joko Santoso, Amar Vijai Nasrulloh

Department of Physics, Faculty of Mathematics and Natural Sciences, University of Lambung Mangkurat, Banjarbaru, Indonesia

Article Info

Article history:

Received Jul 20, 2023

Revised Oct 26, 2023

Accepted Jan 15, 2024

Keywords:

Catfish aquaculture pond
Dissolved oxygen levels
Internet of things-based
NodeMCU ESP8266
Temperature

ABSTRACT

One of the fish in Indonesian waters that has been successfully bred and cultivated is the catfish (*Pangasius sp.*). In catfish farming, there are several water quality factors that need to be considered, such as temperature and dissolved oxygen levels. Based on the existing description, it is very important to pay attention to the water quality of aquaculture ponds, especially temperature and dissolved oxygen levels for fish survival. This study aims to create an internet of things (IoT) based monitoring system for temperature and dissolved oxygen levels in catfish aquaculture pond water based on NodeMCU ESP8266. Monitoring system is using SEN0237 gravity analog dissolved oxygen sensor, DS18B20 sensor module, NodeMCU ESP8266, 20x4-character liquid-crystal display (LCD), micro secure digital (SD) card module, internet modem. Data from measurements of temperature and dissolved oxygen levels are stored online in the Adafruit.io database in the .csv format and on a micro secure digital (SD) card in the device in the .txt format. The lowest value of dissolved oxygen levels and temperature are 3.4 mg/L or 3.4 ppm and a temperature of 27.9 °C, respectively. Meanwhile, the highest value of dissolved oxygen levels and temperature are 4.6 mg/L or 4.6 ppm and temperature of 30.9 °C, respectively.

This is an open access article under the [CC BY-SA](https://creativecommons.org/licenses/by-sa/4.0/) license.



Corresponding Author:

Nurma Sari

Department of Physics, Faculty of Mathematics and Natural Sciences

University of Lambung Mangkurat

70714, Banjarbaru, Kalimantan Selatan, Indonesia

Email: nurmasari01@ulm.ac.id

1. INTRODUCTION

Catfish is one of the native fish in Indonesian waters that grows well. Catfish is a freshwater fish that belongs to the catfish (*Pangasius sp.*) type. Pangasiidae can be mass-produced and offers the potential for industrial-scale development due to its basic characteristics of lacking scales, having few spines, having a fairly fast growth rate, and having high fertility and survival rates. With all these benefits, this fish has increased economic value among fishery commodities, both in the hatchery and grow-out business sectors [1], [2]. In recent times, real time water quality monitoring in aquaculture has been brought by the fast development of internet of things (IoT) technology effectively. Globally, water quality monitoring systems based on IoT and wireless communication technologies have been widely studied intensively [3]–[13].

Dissolved oxygen levels are one of the water quality parameters that can cause large numbers of fish to die. The processes of decomposition, reproduction and development in ponds are hampered by low dissolved oxygen levels. According to Indonesian National Standard (SNI) number 01-6483.3-2000 for catfish culture, dissolved oxygen levels range from >4 mg/L. The need for fish for dissolved oxygen levels depends on the age of the fish, fish activity, and water quality [14]. Dissolved oxygen levels in ponds vary from time to time. Research show that dissolved oxygen levels change due to the influence of changing

temperatures due to unstable weather [15]. According to Effendi [16], dissolved oxygen levels for fisheries must be at least 5 mg/L. If the concentration of dissolved oxygen is not balanced, the fish will be stressed because the brain does not get enough oxygen. Fish will experience anoxia because their body tissues are unable to bind dissolved oxygen in the blood.

The water temperature of fish farming ponds is an important factor. The ideal temperature tolerance range for catfish according to SNI number 01-6483.3-2000 is between 25-30 °C. Pool water temperature affects water quality [17]. Oxygen solubility is one of the characteristics of water quality that is affected by temperature variations. With increasing temperature, the level of solubility of oxygen decreases [18], [19]. Once there is an increase in temperature, the amount of solubility of oxygen in water will decrease. An increase in temperature causes the metabolic activity of fish to be greater which results in a doubling of oxygen consumption in fish. Low water temperature can affect the ability of fish to bind oxygen so that it can inhibit fish development [20]. Fish that experience stress reduce stamina and reduce hunger, and eventually starve to death [16].

The DS18B20 temperature sensor is a device that can read temperature variations and then translate these changes into electrical quantities. This sensor is connected to the microcontroller using a single cable and is a digital sensor. These sensors are special because each sensor contains a serial code that allows the use of multiple DS18B20s in one-wire transmission. This sensor can be used with 3.0 to 5.5 V. The sensor has ± 0.5 °C accuracy from -10 to +85 °C and can be used in the temperature range of -55 to 125 °C (-67 to +257 °F) with a resolution of 9 to 12 bits [21]. SEN0237 gravity analog dissolved oxygen sensor is a sensor for measuring dissolved oxygen levels in water. These sensors are widely used in various water-related sectors, including research, aquaculture, and monitoring of the aquatic environment. This sensor is open source and compatible with various microcontrollers, allowing users to use it freely and openly. This sensor has a galvanic probe type with a detection range of 0 to 20 mg/L. This sensor has a response time of up to 98% full response, within 90 seconds (25 °C) sensor pressure range from 0 to 50 psi with electrode service life generally for 1 year for normal use [22]. NodeMCU ESP8266 is a microcontroller equipped with the ESP8266 chip. This microcontroller has multiple input or output ports to enable monitoring and control applications for IoT projects. The NodeMCU ESP8266 is an evolution of the ESP8266 version of the ESP-12 IoT platform module family. This module works very similarly to the Arduino module platform in terms of functionality, but the difference is "connected to the internet" [23].

Several studies that have been conducted regarding the measurement of water quality in aquaculture ponds. For instance, Moreno-Rodenas *et al.* [24] in 2017 was working on a data acquisition system for measuring dissolved oxygen levels with the results that the average dissolved oxygen level is in the range of 3 to 5 mg/L in rainy conditions and between 3 to 7 mg/L on cloudy conditions. Next, research by Kustija and Andika [25] in 2021, was showing a system for monitoring temperature and dissolved oxygen levels in catfish ponds with the Raspberry Pi that was obtained the water temperature varied with time. Furthermore, research by Bima *et al.* [26] in 2018 built a temperature remote monitoring system in Bangkok tilapia ponds, the effective temperature for fish pond water was an indicator of 28 to 30 °C. To fill the needs of fish consumes, aquaculture methods have been forced to overproduce and resulting in the accelerated water environment degradation and the old of agricultural workers in many parts of the world so will face the dilemma of shortage of labor, and IoT aquaculture method is one of the method that can resolve the issue [27]. Fish farming has been applied widely recently. In Bangladesh, fish monitoring had been studied based on IoT so it notified the user the amount of dissolved oxygen, ammonia level, pH level, and water body temperature. It can help fish farmers to measure the parameters and provide necessary things to grow more fish and facing water pollution [28]. Latest research by Loh *et al.* [29] showed that to address the challenges of maintaining aquatic environment, IoT fish farm monitoring system has been done to provide several features such as temperature, pH, dissolved oxygen, total dissolved solid, and energy usage of the water pump.

Erratic weather patterns cause poor water quality for fish farming, which makes fish susceptible to disease and if it continues will result in mass fish mortality. Based on the existing description, it is very important to pay attention to the water quality of aquaculture ponds, especially temperature and dissolved oxygen levels for fish survival. In this research, a remote and IoT based monitoring system for temperature and dissolved oxygen levels in catfish farming ponds will be made using the DS18B20 and SEN0237 gravity analog dissolved oxygen sensor internet-based sensors which will be tested and implemented in catfish farming ponds. This monitoring system uses NodeMCU ESP8266 as a microcontroller and Adafruit.io as an online interface. By applying IoT technology with an internet network, this up-to-date technology is able to send data and offer speed and a vast distance [30]. This research develops IoT technology for sending parameter data from dissolved oxygen level and temperature directly to a web server. Then, the stored data for 24 hours on the webserver can be processed for further identification all the time.

2. RESEARCH METHOD

2.1. Material

The materials used are the sensor modules which are DS18B20 temperature sensor and SEN0237 gravity analog dissolved oxygen sensor. Next is the microcontroller kit that consists of NodeMCU ESP8266, 20×4-character liquid-crystal display (LCD) with inter-integrated circuit (I2C) and secure digital (SD) card module. It is also supported by 12 V 2 A adapter, step down DC to DC converter, tin, electronic components, connecting cables, and control panel box.

2.2. Method

2.2.1. Hardware

The proposed of the NodeMCU ESP8266-based IoT monitoring system for temperature and dissolved oxygen consists of several stages starting with preparing the tools and materials needed in this research (Figure 1). It proceeds with assembling the hardware, namely integrating the NodeMCU ESP8266 with the sensor, and assembling a remote monitoring system for temperature and dissolved oxygen based on the NodeMCU ESP8266. Furthermore, the manufacture of software includes the manufacture of microcontroller software, manufacture of LCD interface software and manufacture of IoT software. Followed by determining the transfer function of measuring instruments, testing the system as a whole and finally data collection. The details of the proposed system can be seen clearly in Figure 1(a). Meanwhile, Figure 1(b) shows layout of the circuit design of remote monitoring of temperature and dissolved oxygen levels based on Node MCU ESP8266. It is included SEN0237 analog dissolved oxygen sensor, DS18B20 sensor, SD Card module, and 20×4 characters I2C LCD module are integrated into the NodeMCU ESP8266.

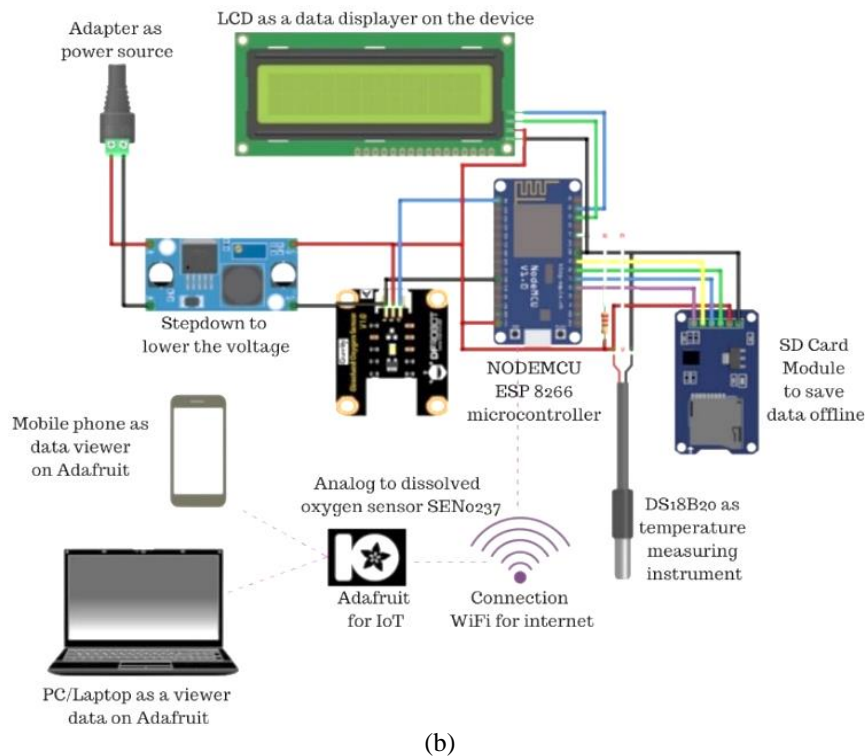
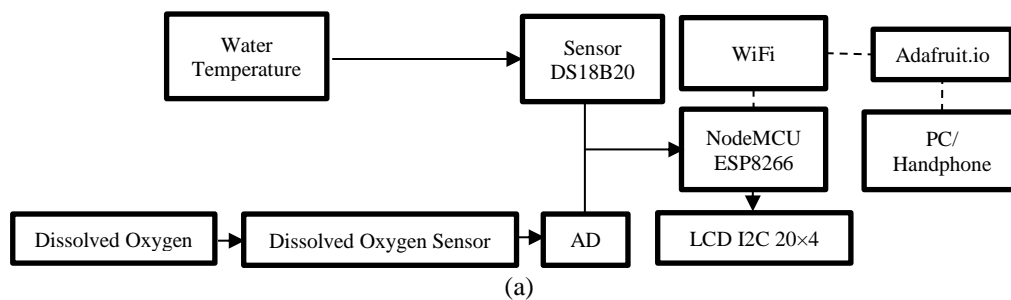

Figure 1. Proposed system of (a) block diagram and (b) circuit design

2.2.2. Software

Figure 2 shows the function of NodeMCU ESP8266 for both with sensors and LCD and also with IoT. The software on NodeMCU ESP8266 is made using the Arduino integrated development environment (IDE) software. The software interface to LCD using Arduino IDE software that connecting between NodeMCU ESP8266 and sensors (DS18B20 dan SEN0237 analog dissolved oxygen sensor). The stages include LCD pin configuration, library input, and giving commands to retrieve data from the output of the measuring instrument circuit. The flowchart of the programme interface to display characters on the LCD can be seen in Figure 2(a).

Calibration was accomplished by comparing the measured value on the sensor with the measured value on a standard measuring instrument. For the DS18B20 sensor, a digital thermometer is used as a comparison. The measurement range used is 10 to 50 °C. Meanwhile, for the SEN0237 grativity analog dissolved oxygen sensor, a dissolved oxygen meter is used as a comparison. Measurements were made using zero dissolved oxygen powder which was added little by little until a measured dissolved oxygen value of 0 mg/L was obtained.

Figure 2(b) presents connection of NodeMCU ESP8266 with IoT. The system developed by the Arduino IDE software and the IoT interface used Adafruit.io. In details, to connect NodeMCU ESP8266 with IoT, it is mandatory to write down the WiFi name and password of the wifi used. To link readings to Adafruit.io, the listing should include the Adafruit.io web address, the username of the Adafruit.io account used, the active key, and the name of the feed used. The monitoring system that is made is tested first by observing each part whether it is working properly. Next, a performance check of the NodeMCU ESP8266 is carried out by connecting to the internet so that it reads Adafruit.io. After connected to the internet and a notification appears that Adafruit.io has been connected, a comparing the values between on the LCD of the device and Adafruit.io. Once the reading value of the measuring instrument that appears is appropriate, the tool can be used.

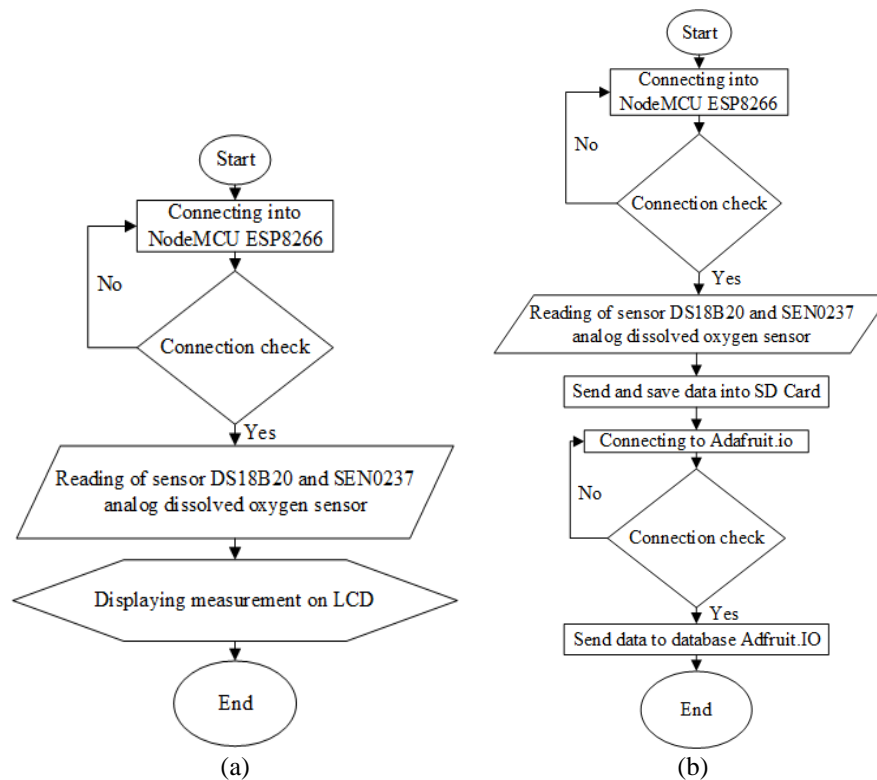

Figure 2. Flowchart of NodeMCU ESP8266 with (a) sensors and LCD, and (b) IoT

Calibration was accomplished by comparing the measured value on the sensor with the measured value on a standard measuring instrument. For the DS18B20 sensor, a digital thermometer is used as a comparison. The measurement range used is 10 to 50 °C with the sensor readings obtained, the (1) is obtained.

$$y = 1,0129x + 0,2557 \text{ with } R^2 = 1 \quad (1)$$

The (1) is then entered into the Arduino program. It is intended that the readings from the DS18B20 sensor are the same as standard measuring instruments. After the equation is entered into the Arduino program, retesting is carried out with a temperature range of 20 to 35 °C as a representative of the reasonable limit for measuring catfish pond water. Data on the results of retesting the DS18B20 sensor can be seen in Table 1. Meanwhile, for the SEN0237 grativity analog dissolved oxygen sensor, a dissolved oxygen meter is used as a comparison. Measurements were made using zero dissolved oxygen powder which was added little by little until a measured dissolved oxygen value of 0 mg/L was obtained. Based on the sensor readings obtained, the (2) is obtained.

$$y = 126,22x - 129,85 \text{ with } R^2 = 0,9664 \quad (2)$$

The (2) is then entered into the Arduino program. This aims to convert the reading from SEN0237 analog dissolved oxygen sensor into mg/L like the reading from dissolved oxygen meter. After the equation is entered into the Arduino program, a retest is carried out using local government-owned water utility (PDAM) water with calibration powder added little by little until the dissolved oxygen level in PDAM water becomes 0 mg/L. The data of SEN0237 analog dissolved oxygen sensor retest can be seen in Table 2.

Table 1. DS18B20 sensor retest result data

No	Calibrator (\bar{x})	DS18B20 sensor (\bar{x}_i)	Difference ($\bar{x}-\bar{x}_i$)	Error (%)
1	20	20	0	0.00
2	21	21.02	-0.02	0.10
3	22	22.03	-0.03	0.14
4	23	23.04	-0.04	0.17
5	24	23.99	0.01	0.04
6	25	25.00	0.00	0.00
7	26	26.02	-0.02	0.08
8	27	27.03	-0.03	0.11
9	28	28.04	-0.04	0.14
10	29	28.99	0.01	0.03
11	30	30.01	-0.01	0.03
12	31	31.02	-0.02	0.06
13	32	32.03	-0.03	0.09
14	33	33.04	-0.04	0.12
15	34	34.06	-0.06	0.18
16	35	35.01	-0.01	0.03
Error mean				0.1

Table 2. Result of the retest data on SEN0237 analog dissolved oxygen sensor

No	Calibrator (\bar{x})	SEN0237 sensor (\bar{x}_i)	Difference ($\bar{x}-\bar{x}_i$)	Error (%)
1	6.50	6.82	-0.32	4.92
2	6.03	6.57	-0.54	8.9
3	5.90	6.07	-0.17	2.82
4	5.70	5.58	0.12	2.05
5	5.27	5.18	0.09	1.71
6	4.53	4.35	0.18	4.12
7	3.80	3.09	0.71	18.77
8	2.53	1.75	0.78	31.05
Error mean				9.3

2.2.3. System realization

Figures 3 show the location and configuration of the equipment and its placement in the catfish farming pond. Pre-data collection was retrieved for 2 days to determine the readiness of the tool before the actual data collection was carried out. Pre-data collection was carried out during weather conditions after rain and in ponds with cloudy weather conditions accompanied by rain. Data monitoring can be monitored via mobile phones and laptops or other devices that can access the internet. To monitor the measurement results via the internet, users can open the link that has been provided for this monitoring system. Measurements will begin when the NodeMCU ESP8266 microcontroller is connected to the internet. The process of connecting the microcontroller to the internet takes ± 40 seconds depending on the speed of internet access. The better the internet network used, the faster the microcontroller is connected. If the internet network is disconnected, the data displayed is the last data before the network is disconnected. This monitoring system has a weakness in

the dissolved oxygen sensor used, which is a probe filling solution sensor that must always be monitored. During the pre-take, it is known that the effective use of the probe filling solution is about 3-4 hours. Therefore, every 3-4 hours it is necessary to check and replace the probe filling solution so that the measurement results obtained have a good value. The probe filling solution used should always be in good condition and no bubbles should form on the filling membrane. The formation of bubbles and poor probe filling solution can affect the measurement results.

Location of the ponds in this research can be clearly seen in Figure 3(a). The laying tools in the field using a box that is given a hole and then associated with a paralon pipe tied to the bridge. The tool box, modem, and power outlet (Figure 3(b)) are placed in a green box which is then given a hole for the sensor probe. The sensor probe is connected to the outside of the box and then inserted into the paralon pipe that has been tied to the bridge to prevent the position of the probe from moving if it is hit by a fish that has an impact on the measurement (Figure 3(c)).

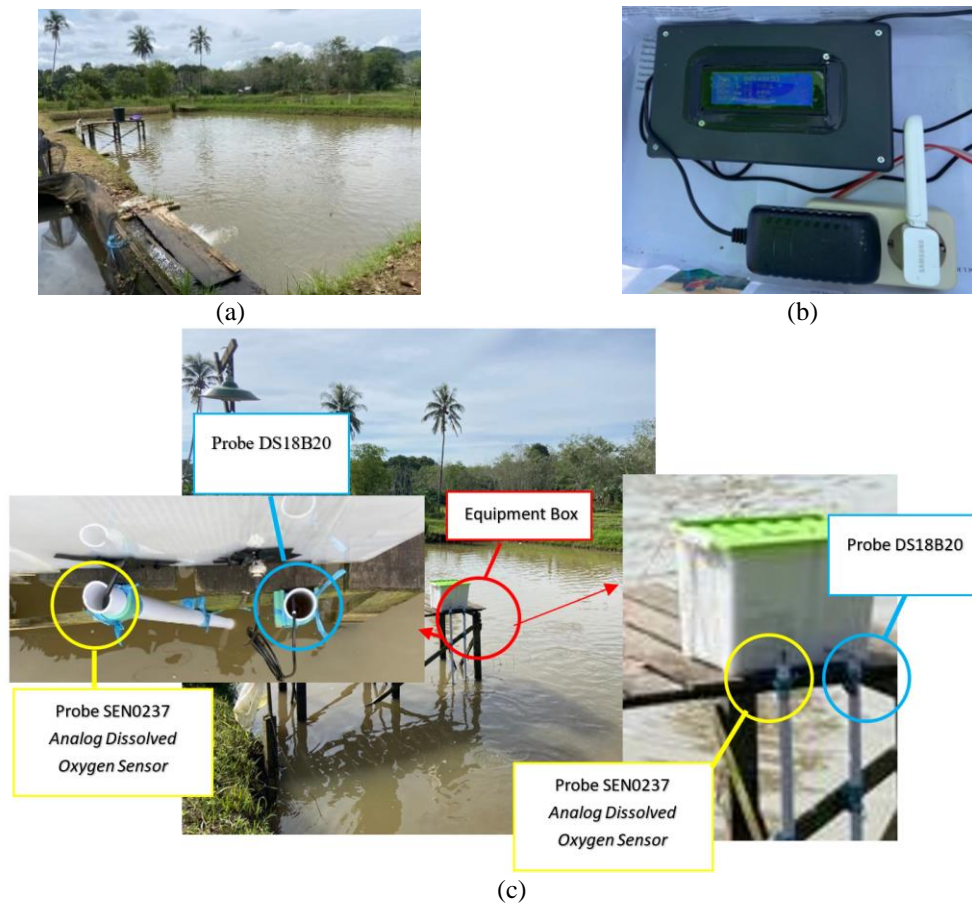

Figure 3. The location and configuration of the equipment and its placement in the catfish farming pond by (a) location of catfish ponds where data is collected, (b) measurement and IoT system processing equipment, and (c) IoT based monitoring system for temperature and dissolved oxygen levels in catfish farming ponds

3. RESULTS AND DISCUSSION

The calibration process of the SEN0237 analog dissolved oxygen sensor. Measurements were carried out three times using water mixed with zero dissolved oxygen powder until the dissolved oxygen level in the water was 0 mg/L. Based on the results of the sensor readings obtained the regression formula in (2) and adapted into Arduino program. From the results of retesting conducted, it is known that the average error in sensor readings is 9.3% (Table 2). Meanwhile, based on the results of the DS18B20 temperature sensor during calibration, it is obtained the regression formula in (1). This equation is then adapted into the Arduino program. It is intended that the readings from the DS18B20 sensor are the same as standard

measuring instruments. From the results of retesting, it is known that the average error value of reading is 0.1% (Table 1).

The readings that appear on the Adafruit.io dashboard are temperature, dissolved oxygen (mg/L), and dissolved oxygen (ppm) in the form of images and gauges. Figure 4 is the interface display on Adafruit.io. The gauge is given a limit value, where if the dissolved oxygen value is below 4 mg/L or 4 ppm and the temperature is below 25 °C and more than 30 °C then the gauge will turn red as a sign that the measurement was carried out in a condition that is not in accordance with SNI number 01-6483.3-2000. Meanwhile, when the measurement results are >4 mg/L or 4 ppm for dissolved oxygen and the temperature is around 25-30 °C, the gauge will turn green. Data display indicators for monitoring can be said to be real-time if the interface for sensor readings that appear on the LCD and the Adafruit.io dashboard is "same". Figure 5 shows the real-time readings of the Adafruit.io LCD and dashboard.

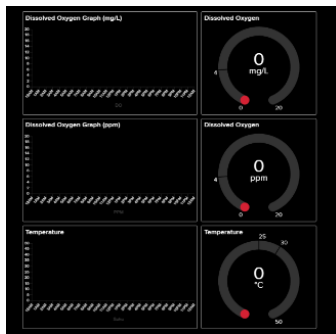

Figure 4. Adafruit.io display developed

Figure 5. Testing and validating of the IoT-based system

Data measurement from the downloaded of Adafruit.io database is in .csv file format, while stored on the micro SD card is in the .txt file format (Figure 6). Data stored in the Adafruit.io database can be downloaded in .csv file format for each feed (Figure 6(a)). Along side stored online in the Adafruit.io database, measurement data is also stored offline on a micro SD card in the form of a .txt file. The stored data contains time data, SEN0237 analog dissolved oxygen sensor readings in mg/L and ppm units, as well as DS18B20 sensor module readings which are separated by commas “,”. This data can be converted into an spreadsheet table for comparative image analysis. Figure 6(b) shows the .txt file data written to and stored on the micro SD card.

A1							
	A	B	C	D	E	F	G
1	id,value,feed_id,created_at,lat,lon,ele						
2	0F8ZMY63POV2G9JWNSPJRB8T,1.03,2490571,2023-03-30 05:29:32 UTC,...						
3	0F8ZMYX9RQ71RJ5D2819HWWBP4,1.03,2490571,2023-03-30 05:29:42 UTC,...						
4	0F8ZM20D7XFMCCGJ56Z27G1X1,1.03,2490571,2023-03-30 05:29:52 UTC,...						
5	0F8ZM23G3WG11VKYRE03KHFVR1,1.03,2490571,2023-03-30 05:30:02 UTC,...						
6	0F8ZM26K65RCQD8P81XCDO49H,1.03,2490571,2023-03-30 05:30:13 UTC,...						
7	0F8ZM29NM9YEV59YJCVGG8H,1.03,2490571,2023-03-30 05:30:23 UTC,...						
8	0F8ZM2CQTHNW030T3QVFW3F2C2,1.03,2490571,2023-03-30 05:30:33 UTC,...						
9	0F8ZM2FT28NG7W7Q6VMSQ29QG8,1.03,2490571,2023-03-30 05:30:43 UTC,...						
10	0F8ZM2JWSG776YHRJZ6QVZ1G,1.03,2490571,2023-03-30 05:30:53 UTC,...						
11	0F8ZM2QZ7F1KRJZTF58K89G3D9,1.03,2490571,2023-03-30 05:31:07 UTC,...						
12	0F8ZM2S65W112NV6I4J7NQ1S4,1.03,2490571,2023-03-30 05:31:14 UTC,...						
13	0F8ZM2WBX6FQ851204HKCXXA39,1.03,2490571,2023-03-30 05:31:24 UTC,...						
14	0F8ZM2ZCJT0T7X7QA22E4G56A,1.03,2490571,2023-03-30 05:31:34 UTC,...						
15	0F8ZM2Q2G2QNQTZVF9NTYB91B2,1.03,2490571,2023-03-30 05:31:44 UTC,...						
16	0F8ZM2N05KEF90C2MPM4N9GH38R0,1.03,2490571,2023-03-30 05:31:54 UTC,...						
17	0F8ZM2N08X8GYP13WHDAMQ9K8E,1.03,2490571,2023-03-30 05:32:05 UTC,...						
18	0F8ZM2N08V4N6791EXCR2PW1MSA,1.03,2490571,2023-03-30 05:32:15 UTC,...						
19	0F8ZM2N0EXF5128KB2KM5DYN8Y9,1.03,2490571,2023-03-30 05:32:25 UTC,...						
20	0F8ZM2N07TEP5153CS87WY2JHC,1.03,2490571,2023-03-30 05:32:35 UTC,...						
21	0F8ZM2N041RY9G2N31V4ZCT0JT,1.03,2490571,2023-03-30 05:32:45 UTC,...						

(a)

```

Waktu,Dissolved Oxygen (mg/L),Waktu,Dissolved Oxygen (ppm)
07:27:19,2.55,2.55,26.91
07:27:30,2.50,2.50,27.73
07:27:40,2.55,2.55,27.67
07:27:50,2.47,2.48,27.67
07:28:00,2.52,2.52,27.67
07:28:10,27.37,27.40,27.67
07:28:21,8.79,8.80,27.60
07:28:31,7.84,7.85,27.54
07:28:41,7.48,7.49,27.35
07:28:51,7.48,7.49,27.16
07:29:01,7.05,7.05,27.35
07:29:12,4.95,4.96,27.22
07:29:22,3.96,3.96,27.79
07:29:32,3.50,3.50,27.79
07:29:42,3.52,3.52,27.86
07:29:52,3.39,3.40,-128.38
07:30:03,3.39,3.40,27.86
07:30:13,3.50,3.50,27.86
07:30:23,3.27,3.27,27.86
07:30:33,3.34,3.34,27.86
07:30:43,3.29,3.29,27.86
    
```

(b)

Figure 6. Display of measurement results data of (a) the downloaded from the Adafruit.io database in .csv file format and (b) the .txt file data written to and stored on the micro SD card

Data collection was retrieved for three days (Figure 7). The measuring instrument is placed on a bridge with a height of ±80 cm from the water surface with the sensor probe submerged about 2-4 cm from

the water surface. During data collection, the weather is constantly changing. Data collection on first day was in cloudy weather conditions accompanied by rain during the day. The relationship between temperature and dissolved oxygen levels from data collection on the first day can be seen in Figure 7(a). From the figure it is known that when the temperature increases the dissolved oxygen levels decrease and vice versa. From the Figure 7(a), the relationship between temperature and dissolved oxygen levels is most clearly seen at point a at 13:15, where the dissolved oxygen value reaches 4.5 mg/L or 4.5 ppm with a measured temperature of 28.6 °C. It also shows a decrease in dissolved oxygen values and temperature due to rain during the day, from 13:15 to 14:30. Apart from when it rains, dissolved oxygen values and measured temperatures also tend to decrease at night at 19:15. The dissolved oxygen value measured after rain and at night fell below 4 mg/L.

Data collection on second day was cloudy in the morning, then hot during the day and cloudy again in the late afternoon. Figure 7(b) is a graph of the relationship between temperature and dissolved oxygen levels. From the Figure 7(b) it is known that when the temperature increases the dissolved oxygen level decreases and vice versa as seen at 19:30 to 20:00. In some conditions there are temperature values that are not in accordance with the theory, such as at points d to e where the temperature values measured exceed the value of 30 °C at 13:00 to 17:30 caused by the hot sun during the day. The dissolved oxygen value between 10:00 and 11:30 is measured to be less than 4 mg/L in the morning with cloudy weather conditions after rain. The low dissolved oxygen value measured is the dissolved oxygen value measured at the time of changing the probe filling solution because when changing the probe is removed from the water. The low dissolved oxygen measured, aside from the effect of temperature, is also caused by other factors such as the water level and the water content.

Data collection on third day in sunny weather conditions in the morning then hot during the day, cloudy in the late afternoon accompanied by rain at night. Figure 7(c) is a graph of the relationship between temperature and dissolved oxygen levels. The Figure 7(c) during the temperature increases the dissolved oxygen levels decrease and vice versa. The relationship between temperature and dissolved oxygen can be seen at 15:45 to 17:15 once dissolved oxygen increases the temperature value decreases. In some conditions there are temperature values measured outside the limits of SNI provisions at 11:30 to 16:30 with the measured values are more than 30 °C. This condition occurs due to the hot weather during the day that causes the temperature to increase. Dissolved oxygen values that were measured outside the regulatory limits were seen between 10:00 and 10:45 and at 17:15 to 20:00, where dissolved oxygen values were measured below 4 mg/L. The low dissolved oxygen measured apart from temperature is also caused by other factors such as water level and water content. From the data image, the most obvious one is at 14:00 where the dissolved oxygen value reaches 4.2 mg/L or 4.2 ppm with a measured temperature of 30.9 °C.

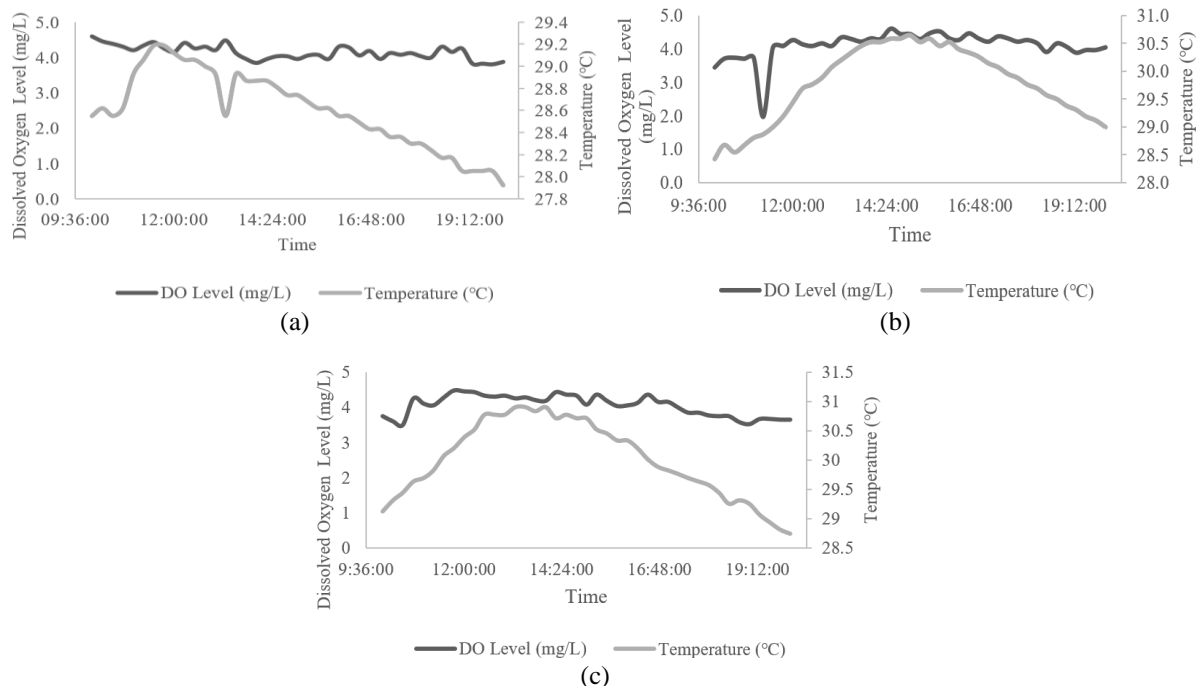

Figure 7. Data collection of dissolved oxygen level (black line) and temperature (gray line) for three days (a) first day, (b) second day, and (c) third day data collection

Based on measurements carried out for three days, from 10:00 to 20:00 (Table 3), it is known that the temperature and dissolved oxygen values of the Karang Intan catfish pond are relatively safe and quite good. In the morning dissolved oxygen in fish pond water is quite low, then it increases as the day progresses. When it rains, the measured dissolved oxygen levels also decrease. This is similar to research conducted by Mardhiya *et al.* [31] in 2017 which obtained an average dissolved oxygen level in the range of 3 to 5 mg/L in rainy conditions and a range of 3 to 7 mg/L in cloudy conditions. Abundant oxygen levels during the day with sunny weather due to the process of respiration by macrophytes in the mechanism of photosynthesis with the help of sunlight. While at night dissolved oxygen decreased again. The decrease in dissolved oxygen levels at night is due to the absence of photosynthesis at night, also caused by the level of temperature fluctuations by the air, the increased respiration rate of sediment by bacteria and the more intense respiration rate in fish ponds by aquatic organisms. As for the temperature, it is influenced by the surrounding conditions. As the day gets darker, when the weather is cloudy and it rains, the measured temperature decreases and vice versa, when the weather is sunny and the sun is hot enough, the measured temperature increases. This is similar to research conducted by Sumardiono *et al.* [32] in 2020, for example when it is sunny the temperature will rise to around 29 °C, when it is foggy it will drop to around 27.7 °C, and at night it will generally drop to around 29.4 °C. The graph of the maximum and minimum values of dissolved oxygen and temperature measured for 3 days can be seen in Figure 8.

Table 3. Maximum and minimum values of data for three days of measurement

Day	Dissolved oxygen (mg/L)				Temperature (°C)			
	Time	Max	Time	Min	Time	Max	Time	Min
1	10:00:01	4.6	19:45:01	3.81	11:45:09	29.19	20:00:37	27.92
2	14:30:15	4.6	10:00:42	3.44	15:00:09	30.64	10:00:42	28.43
3	11:45:20	4.49	10:30:05	3.5	13:30:38	30.9	20:00:12	28.74

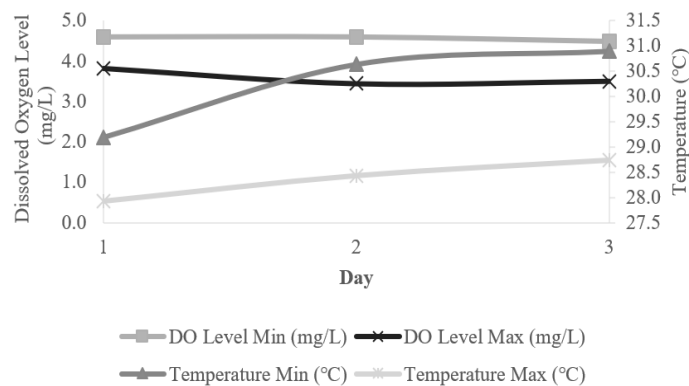

Figure 8. The maximum and minimum values of dissolved oxygen level and temperature of 3 days of measurement

In Figure 8 it can be seen that dissolved oxygen tends to be lower in the morning, then increases as the day progresses. During 3 days the measurement was carried out, the dissolved oxygen levels and temperature measured during the measurement had the lowest value of 3.44 mg/L or 3.44 ppm with a temperature of 27.92 °C and the highest value of 4.6 mg/L or 4.6 ppm with a temperature of 30.9 °C. From the measurements taken, it is known that dissolved oxygen levels have good values during the daytime, while in the morning and night have poor values. The maximum value of dissolved oxygen that was measured was obtained at 10:00, 14:30, and 11:45. At night dissolved oxygen tends to decrease, where from the data obtained it is recorded that the minimum dissolved oxygen value is at 19:45, 10:00, and 10:30. Meanwhile, the temperature tends to increase during the day and decreases in the afternoon until the evening. From the data recorded from measurements for three days, it was found that the temperature experienced a maximum value at 11:45, 15:00, and 13:30. The minimum temperature recorded is at 20:00 and 10:00. The low temperature measured in the morning is caused by temperature changes that occur at night accompanied by rain, so that when measurements are taken in the morning the measured temperature tends to be low. From the measurement data obtained, it is known that dissolved oxygen levels are indeed affected by temperature, but this factor does not have a significant effect. There are other factors that affect dissolved oxygen levels in

fish pond water. Even so, the water quality measured in the catfish pond is fairly good because the dissolved oxygen and measured temperatures are still within safe limits. The circulation of fish pond water is quite good so that even though the measured dissolved oxygen was below the SNI number 01-6483.3-2000 standard for catfish cultivation, dissolved oxygen can again increase to the threshold according to SNI number 01-6483.3-2000. This system also spent a low cost for its operation. In details, for the distilled water solution as a neutralizer or rinsing probes before and after use, approximately 500 ml of distilled water is enough for one week of data collection. As for probe filling or sodium hydroxide (NaOH) liquid, approximately 30 ml is enough for one week of data collection. Cost calculation for 1 week, 500 ml of distilled water costs USD 0.45 and 30 ml of 0.5 molar NaOH costs USD 0.032 so the total cost for 1 week is USD 0.48. (USD 1=IDR 15,719).

4. CONCLUSION

An IoT-based monitoring system for temperature and dissolved oxygen levels in catfish farming ponds using the DS18B20 and an internet-based dissolved oxygen sensor has been successfully developed. This monitoring system are able to measure temperature and dissolved oxygen levels which have a reading error value for the DS18B20 sensor of 0.1% and for the SEN0237 analog dissolved oxygen sensor 9.3%. The effective value of the probe filling solution on the SEN0237 analog dissolved oxygen sensor is around 3-4 hours. A water quality monitoring system has been implemented in catfish pond in Karang Intan for 3 days starting from 10:00 to 20:00. From the measurements that have been made, it is obtained that the dissolved oxygen level and temperature measured during the measurement have the lowest value of 3.4 mg/L or 3.4 ppm with a temperature of 27.9 °C and the highest value of 4.6 mg/L or 4.6 ppm with a temperature of 30.9 °C. The main limitation of the dissolved oxygen sensor is the effective use of the probe filling solution is about 3-4 hours. Therefore, every 3-4 hours it is necessary to check and replace the probe filling solution. In the future, dissolved oxygen sensor replacement with longer lifetime of used for the probe filling solution replacement. This future research also using photovoltaic cells as independent energy to supply to system so it can be implemented into remote ponds that are unavailable electricity source.



REFERENCES

- [1] S. M. Limbu, "The effects of on-farm produced feeds on growth, survival, yield and feed cost of juvenile African sharp-tooth catfish (*Clarias gariepinus*)," *Aquaculture and Fisheries*, vol. 5, no. 1, pp. 58–64, 2020, doi: 10.1016/j.aaf.2019.07.002.
- [2] Y. Sukrismon, Aripriharta, N. Hidayatullah, N. Mufti, A. N. Handayani, and G. J. Horng, "Smart fish pond for economic growing in catfish farming," in *2019 International Conference on Computer Science, Information Technology, and Electrical Engineering (ICOMITEE)*, IEEE, Oct. 2019, pp. 49–53. doi: 10.1109/ICOMITEE.2019.8921233.
- [3] D. S. Simbeye and S. F. Yang, "Water quality monitoring and control for aquaculture based on wireless sensor networks," *Journal of Networks*, vol. 9, no. 4, pp. 849–849, Apr. 2014, doi: 10.4304/jnw.9.4.840-849.
- [4] L. Xu, N. Wang, Y. Feng, D. Bao, and K. Jorshin, "Design of aquaculture system based on wireless monitoring and its testing," *International Journal of Online and Biomedical Engineering*, vol. 10, no. 5, pp. 68–73, Sep. 2014, doi: 10.3991/ijoe.v10i5.4035.
- [5] L. Hongpin, L. Guanglin, P. Weifeng, S. Jie, and B. Qiuwei, "Real-time remote monitoring system for aquaculture water quality," *International Journal of Agricultural and Biological Engineering*, vol. 8, no. 6, pp. 136–143, 2015, doi: 10.3965/j.ijabe.20150806.1486.
- [6] C. Encinas, E. Ruiz, J. Cortez, and A. Espinoza, "Design and implementation of a distributed IoT system for the monitoring of water quality in aquaculture," in *2017 Wireless Telecommunications Symposium (WTS)*, IEEE, Apr. 2017, pp. 1–7. doi: 10.1109/WTS.2017.7943540.
- [7] M. Zhang, D. Li, L. Wang, D. Ma, and Q. Ding, "Design and development of water quality monitoring system based on wireless sensor network in aquaculture," in *IFIP Advances in Information and Communication Technology*, vol. 347 AICT, no. PART 4, 2011, pp. 629–641. doi: 10.1007/978-3-642-18369-0_76.
- [8] S. Saha, R. H. Rajib, and S. Kabir, "IoT based automated fish farm aquaculture monitoring system," in *2018 International Conference on Innovations in Science, Engineering and Technology (ICISSET)*, IEEE, Oct. 2018, pp. 201–206. doi: 10.1109/ICISSET.2018.8745543.
- [9] C. Dupont, P. Cousin, and S. Dupont, "IoT for aquaculture 4.0 smart and easy-to-deploy real-time water monitoring with IoT," in *2018 Global Internet of Things Summit (GIOTS)*, IEEE, Jun. 2018, pp. 1–5. doi: 10.1109/GIOTS.2018.8534581.
- [10] L. Parra, S. Sendra, L. García, and J. Lloret, "Design and deployment of low-cost sensors for monitoring the water quality and fish behavior in aquaculture tanks during the feeding process," *Sensors*, vol. 18, no. 3, Mar. 2018, doi: 10.3390/s18030750.
- [11] M. Li, C. Lin, J. Ren, and F. Jiang, "A wireless ecological aquaculture water quality monitoring system based on LoRa technology," in *Proceedings of the 2019 International Conference on Wireless Communication, Network and Multimedia Engineering (WCNME 2019)*, Paris, France: Atlantis Press, 2019, pp. 5–7. doi: 10.2991/wcnme-19.2019.2.
- [12] F. A. Saparudin, T. C. Chee, A. S. A. Ghafar, H. A. Majid, and N. Katiran, "Wireless water quality monitoring system for high density aquaculture application," *Indonesian Journal of Electrical Engineering and Computer Science (IJECCS)*, vol. 13, no. 2, pp. 507–513, Feb. 2019, doi: 10.11591/ijeecs.v13.i2.pp507-513.
- [13] L. V. Q. Danh, D. V. M. Dung, T. H. Danh, and N. C. Ngon, "Design and deployment of an IoT-based water quality monitoring system for aquaculture in Mekong Delta," *International Journal of Mechanical Engineering and Robotics Research*, vol. 9, no. 8, pp. 1170–1175, 2020, doi: 10.18178/ijmerr.9.8.1170-1175.
- [14] B. Ali, Anushka, and A. Mishra, "Effects of dissolved oxygen concentration on freshwater fish: a review," *International Journal of Fisheries and Aquatic Studies*, vol. 10, no. 4, pp. 113–127, 2022, doi: 10.22271/fish.2022.v10.i4b.2693.



- [15] G. Zdorovenova *et al.*, “Dissolved oxygen in a shallow ice-covered lake in winter: effect of changes in light, thermal and ice regimes,” *Water (Switzerland)*, vol. 13, no. 17, pp. 1–20, 2021, doi: 10.3390/w13172435.
- [16] X. Dong and J. G. Qin, “Fish adaptation to oxygen variations in aquaculture from hypoxia to hyperoxia,” *Journal of Fisheries and Aquaculture*, vol. 2, no. 2, pp. 23–28, 2011.
- [17] J. S. Lucas and P. C. Southgate, *Aquaculture: farming aquatic animals and plants*, 2nd ed. Wiley, 2012. doi: 10.1002/9781118687932.
- [18] D. A. Chin, *Water-quality engineering in natural systems*. Wiley, 2006. doi: 10.1002/0471784559.
- [19] R. Parker, “Review of life cycle assessment research on products derived from fisheries and aquaculture,” *Sea Fish Industry Authority*, 2012.
- [20] C. E. Boyd and F. Lichtkoppler, *Water quality management in pond fish culture*, no. 22. Auburn: Auburn University, 1979.
- [21] Analog, p. 1, 2015, “Datasheet DS18B20: Programmable resolution 1-wire digital thermometer,” Analog, [Online]. Available: <https://www.analog.com/media/en/technical-documentation/data-sheets/ds18b20.pdf>
- [22] D. A. Aziz, “Webserver based smart monitoring system using ESP8266 node MCU module,” *International Journal Of Scientific & Engineering Research*, vol. 9, no. 6, pp. 801–807, 2018.
- [23] A. Zaini, D. P. Wulandari, and R. Wulandari, “Data visualization on shrimp pond monitoring system based on temperature, pH, and DO (dissolved oxygen) with IoT,” *2020 International Conference on Computer Engineering, Network, and Intelligent Multimedia (CENIM)*, 2020, pp. 174–179, doi: 10.1109/CENIM51130.2020.9297851.
- [24] A. M. Moreno-Rodenas, F. Cecinati, J. Langeveld, and F. H. L. R. Clemens, “Impact of spatiotemporal characteristics of rainfall inputs on integrated catchment dissolved oxygen simulations,” *Water (Switzerland)*, vol. 9, no. 12, pp. 1–21, 2017, doi: 10.3390/w9120926.
- [25] J. Kustija and F. Andika, “Control - monitoring system of oxygen level, pH, temperature and feeding in pond based on IoT,” *REKA ELKOMIKA: Jurnal Pengabdian kepada Masyarakat*, vol. 2, no. 1, pp. 1–10, 2021, doi: 10.26760/rekaelkomika.v2i1.1-10.
- [26] A. Bima, C. Irawan, D. A. W. Laksana, A. D. Krismawan, and F. O. Isinkaye, “A text security evaluation based on advanced encryption standard algorithm,” *Journal of Soft Computing Exploration (JOSCEX)*, vol. 4, no. 4, pp. 250–261, 2023, doi: 10.52465/josce.v4i4.274.
- [27] C. Wang, Z. Li, T. Wang, X. Xu, X. Zhang, and D. Li, “Intelligent fish farm—the future of aquaculture,” *Aquaculture International*, vol. 29, no. 6, pp. 2681–2711, Dec. 2021, doi: 10.1007/s10499-021-00773-8.
- [28] A. T. Tamim *et al.*, “Development of IoT based fish monitoring system for aquaculture,” *Intelligent Automation & Soft Computing*, vol. 32, no. 1, pp. 55–71, 2022, doi: 10.32604/iasc.2022.021559.
- [29] S. H. Loh, P. C. Teh, G. Y. Goay, and J. J. Sim, “Development of an IoT-based fish farm monitoring system,” in *2023 IEEE 13th International Conference on Control System, Computing and Engineering (ICCSCE)*, IEEE, Aug. 2023, pp. 281–286. doi: 10.1109/ICCSCE58721.2023.10237168.
- [30] A. C. Subrata, T. Sutikno, S. Sunardi, A. Pamungkas, W. Arsadiando, and A. R. C. Baswara, “A laboratory scale IoT-based measuring of the solar photovoltaic parameters,” *International Journal of Reconfigurable and Embedded Systems (IJRES)*, vol. 11, no. 2, pp. 135–145, Jul. 2022, doi: 10.11591/ijres.v11.i2.pp135-145.
- [31] I. R. Mardhiya, A. Surtoto, and S. W. Suciya, “Data acquisition system for measuring dissolved oxygen levels in shrimp pond water using a dissolved oxygen (DO) sensor (in Indonesia: *Sistem akuisisi data pengukuran kadar oksigen terlarut pada air tambak udang menggunakan sensor dissolve oxygen (DO)*),” *Jurnal Teori dan Aplikasi Fisika*, vol. 5, no. 2, pp. 133–140, 2017.
- [32] A. Sumardiono, S. Rahmat, E. Alimudin, and N. A. Ilahi, “Temperature control-monitoring system and oxygen levels in catfish cultivation ponds (in Indonesia: *Sistem kontrol-monitoring suhu dan kadar oksigen pada kolam budidaya ikan lele*),” *JTERA (Jurnal Teknologi Rekayasa)*, vol. 5, no. 2, p. 231, 2020, doi: 10.31544/jtera.v5.i2.2020.231-236.

BIOGRAPHIES OF AUTHORS





Nurma Sari    received the bachelor's degree in physics (1996) from University of Diponegoro (UNDIP) and a masters degree in physics (2007) specializing in waveguide antenna from Institut Teknologi Sepuluh Nopember (ITS). She received doctoral degree in physics (2022) at Institut Teknologi Sepuluh Nopember (ITS), Indonesia, funded by BUDI-DN LPDP Indonesia. Her interdisciplinary research interests focus on applying physics, applying electromagnetics, applying optics, and waveguide antenna. She can be contacted at email: nurmasari01@ulm.ac.id.



Yuniar Savitri   was born in Banjarmasin in 2001. Her educational history went to MIN Langkai Palangkaraya, MTsN 1 Model Palangkaraya, MAN Kota Palangkaraya (2019), and completed his studies in the bachelor's degree in physics (2023) in the field of instrumentation at the University of Lambung Mangkurat. His research interests focus on electronics and instrumentation of physics. She can be contacted at email: yuniarsavitri147@gmail.com.





Sri Cahyo Wahyono    received the bachelor's degree in physics (1997) from University of Diponegoro (UNDIP) and a masters degree in physics (2004) specializing in waveguide antenna from Institut Teknologi Sepuluh Nopember (ITS), Indonesia, funded by DIKTI Indonesia. His interdisciplinary research interests focus on applying physics and geophysics. He can be contacted at email: scwahyono@ulm.ac.id.



Joko Santoso    received the bachelor's degree in physics (2019) from University of Lambung Mangkurat (ULM). He is currently a technician in instrumentation and computational physics laboratories at University of Lambung Mangkurat, Indonesia. He can be contacted at email: jokosantoso1507@gmail.com.



Amar Vijai Nasrulloh    received an undergraduate degree in physics (2004) from Institut Teknologi Sepuluh Nopember (ITS) and a master's degree in electrical engineering (2010) specializing in biomedical engineering from Institut Teknologi Bandung (ITB) and a Ph.D. degree in bioimage informatics from Durham University, UK, funded by LPDP Indonesia. He is currently a lecturer in physics study program at University of Lambung Mangkurat, Indonesia. His interdisciplinary research interests focus on applying physics and image processing methods to biology and medicine. He can be contacted at email: amarvijai01@ulm.ac.id.



Nurma Sari <nurmasari01@ulm.ac.id>

[IJRES] Your article has been published in issue November 2024

1 message

4excelente.team@gmail.com <4excelente.team@gmail.com>

Fri, Jul 19, 2024 at 4:05 AM

Reply-To: ijres@iaescore.com

To: nurmasari01@ulm.ac.id, yuniarsavitri048@gmail.com, scwahyono@ulm.ac.id, jokosantoso1507@gmail.com, amarvijai01@ulm.ac.id

Dear Nurma Sari, Yuniar Savitri, Sri Cahyo Wahyono, Joko Santoso, Amar Vijai Nasrulloh:

We are glad to inform you that your paper ID 21040 now is already PUBLISHED in the November 2024 Issue. You can visit IJRES Website or click on this link: <https://ijres.iaescore.com/index.php/IJRES/article/view/21040>.

Herewith we send a certificate for your contribution as author in for International Journal of Reconfigurable and Embedded Systems (IJRES).

We are very thankful to publish your prestige paper.

If there is any inquiry about the certificate, do not hesitate to contact us by this email.

We hope you will publish more papers in the future and spread the journal among your community.

We encourage authors to share their published articles to make it more visible to others and may increase your chances of citation!

Promoting your research is now easy thanks to sharing capabilities on social media websites, where you may already have numerous academic and industry connections, like on Twitter, Facebook, Instagram, LinkedIn, Google Scholar, ORCID, Mendeley, ResearchGate, Web of science, or Academia.edu.

Thank you for your hardwork and your cooperation. Stay Positive, Stay Healthy, and Stay Safe.

Mohamad Arif Munandar
IJRES Editorial Office
on behalf of Managing Director, Journals

**IJRES certificate for authors ID 21040.pdf**

445K

CERTIFICATE

No. 21040/IJRES/A/7/2024

International Journal of Reconfigurable and Embedded Systems

is hereby awarding this certificate to

**Nurma Sari, Yuniar Savitri, Sri Cahyo Wahyono, Joko Santoso, Amar Vijai
Nasrulloh**

as **Authors** for paper entitled:

Design of IoT-based monitoring system for temperature and dissolved oxygen levels
in catfish aquaculture pond water

for Vol 13, No 3: November 2024

July 19, 2024



Prof. Dr. Paolo Crippa
Editor-in-Chief



ISSN 2089-4864
<http://ijres.iaescore.com>