

WEM_A_Study_of_Flood_Disaster_Mitigation_It_the_Tambak_Anyar.pdf

by

Submission date: 19-Apr-2023 10:04PM (UTC+0700)

Submission ID: 2069381848

File name: WEM_A_Study_of_Flood_Disaster_Mitigation_It_the_Tambak_Anyar.pdf (936.61K)

Word count: 4098

Character count: 21220

A Study of Flood Disaster Mitigation It the Tambak Anyar Traditional Polder in Banjar Regency South Kalimantan

NOVITASARI NOVITASARI*¹, HOLDANI KURDI¹, AND EFRI SONIA ADELIA SONATA¹

¹Department Civil Engineering, Faculty of Engineering, Lambung Mangkurat University, Banjarmasin, Indonesia

ABSTRACT

The Tambak Anyar polder is one of the many traditional polders scattered in the Banjar Regency. Nevertheless, this polder is flooded almost every year. The purpose of this research is to evaluate dependable discharge that entering to polder system that can be supported by the river capacity inside the polder for flood mitigation. The method used to estimate the water availability is the Mock Model. Furthermore, the data needed are observed discharge, rainfall, and evapotranspiration data. The results of water availability analysis shown that the maximum dependable flow Q80% obtained is 4.89m³/s in the 1st period of January, and the minimum dependable flow Q80% was 1.37 m³/s in the 2nd period of September. The discharge entering the polder is quite large; the capability of Tambak Anyar River as a conveyor channel only could collect 29.74% from the dependable discharge, while the Rantau Bujur River only could accommodate 7.47% in April. In May, Tambak Anyar River's capability could only collect 7.17% from the dependable discharge, while the Rantau Bujur River could only accommodate 0.81%. The amount of discharge could not be supported by the conveyor river inside the polder. The paddy fields in the Tambak Anyar polder often overflowed caused by excess water. This excess of water caused floods that inundated the polder area and the other areas in Banjar Regency as of the beginning of January 2021. The amount of water that has access to the polder was not counterbalanced by watergates facilities and infrastructure management.

Keywords: flood disaster mitigation, mock model, dependable discharge, Tambak Anyar Traditional Polder

INTRODUCTION

The flood disaster at 11 regencies/cities in South Kalimantan Province in early 2021 had a broad impact both in terms of disaster and the economy. One of the areas that were greatly affected was Banjar Regency. The effect of flood disaster be perceived on the productive sector was 22.5%, including agriculture, plantations, fisheries, and animal husbandry—harvest failure in agricultural land covering an area of 46,235 hectares.

Banjar Regency is one of the wetland areas in South Kalimantan (Bappeda Kabupaten Banjar, 2019). Traditional Polder is one of management wetlands in Banjar Regency is for example Tambak Anyar Polder, Pesayangan Polder, Liang Polder, and many other mini polders around Banjar Regency.

Correspondence Author: Novitasari Novitasari, Universitas Lambung Mangkurat, Indonesia; Email: novitasari@ulm.ac.id.

Journal of Wetlands Environmental Management
Vol 9, No 2 (2021) 14 - 23
<http://dx.doi.org/10.20527/jwem.v9i2.271>

A polder is a reclamation area of land in which, in its original condition, the groundwater level is high. Then it is hydrologically isolated from the surrounding area, and the water level conditions (surface water and groundwater) can be controlled (PUPR, 2018). The state of the polder land is left at its original elevation, or it can also be slightly elevated (Suripin, 2004). Some polders and mini polders in Indonesia are polders in urban areas as the alternative of flood disaster protection (Bouwer, Bubeck and Aerts, 2010)(Wignyosukarto, Mawandha and Rachmad Jayadi, 2015; Mawandha, Jayadi and Budi Wignyosukarto, 2014)(Moerwanto *et al.*, 2009). The community that lives in several villages around the Tambak Anyar traditional polder area uses the polder as agricultural land (Noor, Anwar and Kartiwa, 2017), duck farming business, and brackish and freshwater fisheries (BPS, 2018). This polder has a potential area of 1.474 ha with a functional area as a planting area of 1.050 ha,

draw out from the Astambul sub-district to the Martapura sub-district with a 19km long embankment (Novitasari and Reza Adhi Fajar, 2012).

The area of non-irrigated paddy fields in the Martapura Timur sub-district is 11.3 m² out of 29.99 km², which is almost entirely included in the Tambak Anyar Traditional Polder system (BPS, 2018) as shown in Figure 1. The area used for rainfed paddy farming is 190 ha, and paddy fields, lowland, and polder are 1,411 ha. Based on data on the flood incident in early 2021, almost 100% of the rice fields in the polder were

inundated. The sub-district data in 2018 figures show for lowland rice farming with a planting area of 1206 ha, with a damaged area of 214 ha (BPS, 2018). A field survey conducted on March 10, 2021, provided information that the condition of several villages located around this polder was still flooded. This condition caused most agricultural lands, residents' houses, and the main village roads have been submerged. Therefore, research is needed to analyze how much water availability in the Tambak Anyar Traditional Polder for water resources management based on flood disaster mitigation.

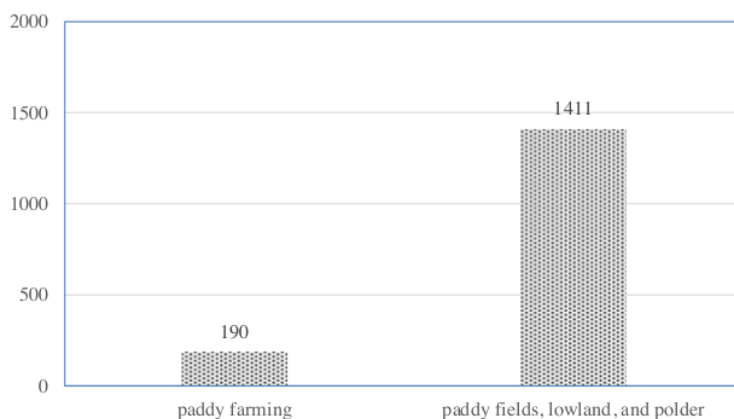

Figure 1. Tambak Anyar Irrigation Land Use (BPS, 2018)

MATERIAL AND METHODS

The research location is Tambak Anyar Traditional Polder, East Martapura District, Banjar Regency, South Kalimantan Province (Figure 2).

Observed data in this research are rainfall, climatological, and discharge data. These rainfall and climate data are collected from the Banjarbaru Class I Climatology Station, located at coordinates -3° 27' 44" South Latitude and 114° 50' 24" East Longitude. The length of the calculated observation data is for 20 years (the Year 2001 – The year 2020). Discharge data were collected from the publication of South

Kalimantan river discharge data by the Regional Settlement and Infrastructure Department of the Province of South Kalimantan. Insitu discharge data had been collected.

Discharge data is also collected from in situ measurement observations with a current meter in April and May 2021. Measurements were made on two tributaries in the Tambak Anyar traditional polder, namely the Rantau Bujur River and the Tambak Anyar River. These two rivers are conveyor's channels. A river that carries water to flow through the paddy fields in the polder. The position of the two rivers can be seen in Figure 3.

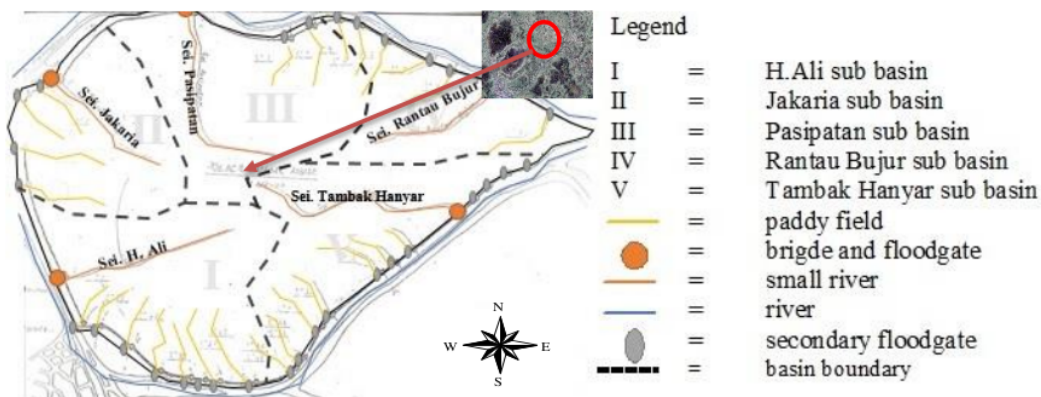

Figure 2. Tambak Anyar Traditional polder map (Bappeda Kabupaten Banjar, 2019)

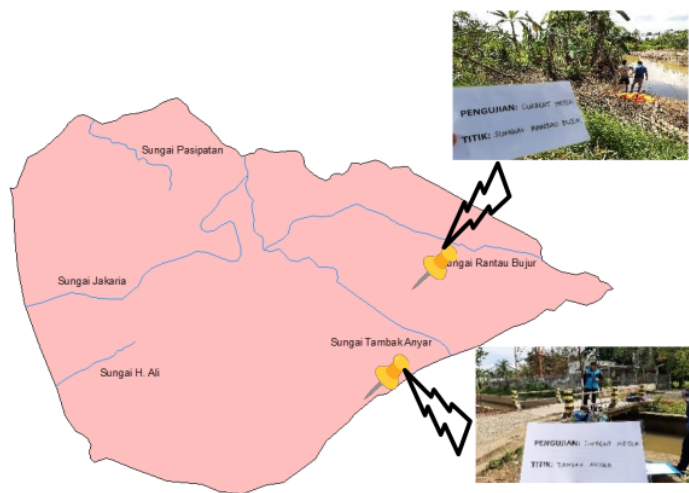

Figure 3. In situ discharge measurement in the Tambak Anyar traditional polder

Evapotranspiration

Evaporation takes place when water turns into steam and moves into the air. Transpiration is the vaporization of water from plants that move into the air (Allen, 1998). Transpiration and

evaporation together are called evapotranspiration (Sosrodarsono and Takeda, 2003). One of the models to estimate evaporation recommended by FAO is the Penman-Monteith Method. The Penman-Monteith evapotranspiration formula is as follows:

$$ET_o = \frac{0,408\Delta(Rn - G) + \gamma \frac{900}{T + 273} u_2 (e_s - e_a)}{\Delta + \gamma(1 + 0,34u_2)} \dots\dots\dots (1)$$

Where:

- ET_o = reference evapotranspiration (mm/day)
- R_n = net radiation at the crop surface (MJ/m²/day)
- G = soil heat flux density (MJ/m²/day)
- T = mean daily temperature at 2 m height (°C)
- u_2 = wind speed at 2 m height (m/s)
- e_s = saturation vapour pressure (kPa)
- e_a = actual vapour pressure (kPa)
- $e_s - e_a$ = saturation vapour pressure deficit (kPa)
- Δ = slope vapour pressure curve (kPa/°C)
- γ = psychrometric constant (kPa/°C)

Water Availability and Dependable Flow

Water availability is the amount of water available at a location to fulfill specific needs. Water availability was analyzed by the mock method (Nurrochmad *et al.*, 1998). This method requires 15 days per month rainfall data, evapotranspiration data, and measured discharge data as a tool for calibration.

At the stage of the calibration process for the measured discharge, the value of the correlation coefficient (R) and the value of the Volume Error (VE) will be obtained. The correlation coefficient (R) is the magnitude of the relationship between the observed discharge value and the calculated discharge value, the value of correlation coefficient approach to 1 (one). The Volume Error (VE) value is the difference between the observed discharge value and the calculated discharge value, where VE is said to be good if the result is less than 5%. Based on the discharge calibration, the value of the correlation coefficient (R) formula can be seen below.

$$R = \sqrt{\frac{Dt^2 - D^2}{Dt^2}} \dots \dots \dots (2)$$

Where:

$$Dt^2 = \sum_{i=1}^N (Q^i_{obs} - \bar{Q})^2$$

$$D^2 = \sum_{i=1}^N (Q^i_{obs} - Q^i_{sim})^2$$

$$\bar{Q} = \frac{\sum_{i=1}^N Q^i_{obs}}{N}$$

The formula can calculate

volume Error (VE):

$$VE = \frac{\sum_{i=1}^N Q^i_{obs} - \sum_{i=1}^N Q^i_{sim}}{\sum_{i=1}^N Q^i_{obs}} \dots \dots \dots (3)$$

Where:

- Q^i_{sim} = simulation discharge of the *i* period (m³/s)
- Q^i_{obs} = observation discharge of the *i* period (m³/s)
- \bar{Q} = average observation discharge (m³/s)
- N = the amount of data

Dependable discharge analysis needs to be done to determine the average discharge entering the polder (Milianto *et al.*, 2020). Dependable discharge can be used as water for irrigation systems in the polder. The dependable discharge is the minimum river discharge expected to always be available in the river, with the possibility of being fulfilled at a certain level of confidence expected to fulfill irrigation needs. The minimum river discharge for the opportunity to be fulfilled is set at 80% (Bambang Triadmodjo, 2008). The methods used in this stage are from SNI 6738:2015 (SNI 6738, 2015). The magnitude of the dependable discharge with an 80% chance of being met is determined using the Weibull equation with the following formula.

$$P = \frac{m}{n+1} \times 100\% \dots \dots \dots (4)$$

Where:

- P = probability (%)
- m = serial number of data from largest to smallest
- n = number of data

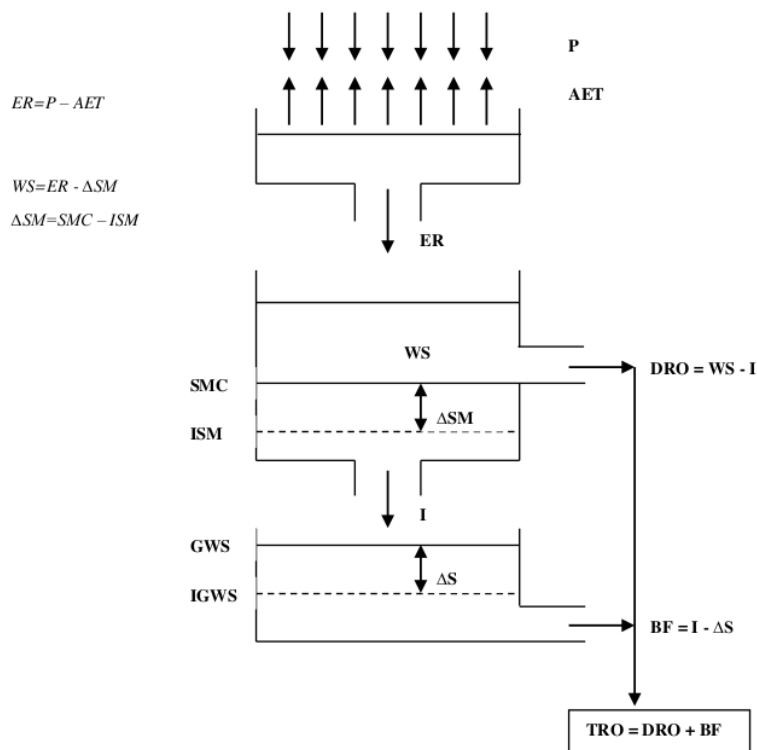

Figure 4. Mock methods schema (Nurrochmad *et al.*, 1998)

RESULTS

Discharge Measurement

Discharge measurement using Current Meter was carried out in two rivers that provide water to

agricultural areas in Tambak Anyar Traditional Polder: Tambak Anyar River and Rantau Bujur River. The following Table 1 shows the measurement results.

Table 1 Discharge Measurement Results in Tambak Anyar River and Rantau Bujur River

Month	Year	Discharge (m ³ /s)	
		Tambak Anyar	Rantau Bujur
April	2021	0.8	0.201
May	2021	0.16	0.018

Evapotranspiration Analysis

The data used in this calculation is Banjarbaru climate data of 2001 – 2020, such as air temperature, air humidity, solar radiation duration, and wind speed. The average daily air temperature ranged from 19.91 to 29.56⁰C. The

average relative humidity ranges from 66.10 to 90.94%. The average solar irradiation time ranges from 1.06 to 8.29, and the average wind speed ranges from 0.37 to 2.97. The recapitulation of evapotranspiration (mm/day) of 2001 – 2020. The half-month average of evapotranspiration is shown in Figure 5.

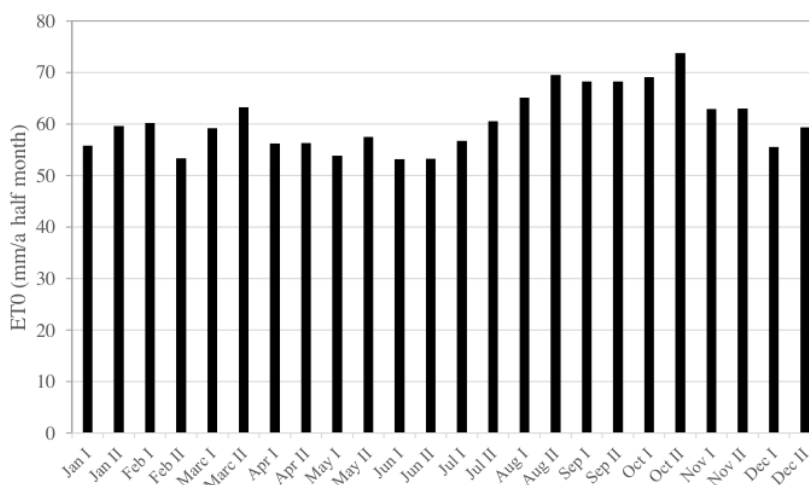

Figure 5. Evapotranspiration per half month

The results of the evapotranspiration analysis based on Figure 5 shown that the evapotranspiration value tends to fluctuate irregularly in specific years. This is due to data that is not available on a particular day, month, or year to affect the calculation results. The results of the evapotranspiration calculation using the Penman-Monteith Method is the maximum evapotranspiration occurred in September 2019, with a value of 7.57 mm/day. Meanwhile, the minimum evapotranspiration value of 1.15mm/day occurred in April 2015. The average daily evapotranspiration for 2001 – 2020 was 4.17 mm/day. The average daily evapotranspiration in the research site is about 3.72 – 4.83 mm per day—the lower rate in June and the highest rate in October. A minimum of half month evapotranspiration is about 53.16 mm/half month in 1st period of June, and the

maximum of evapotranspiration in 2nd period of October is 73.70 mm/half month.

Water Availability Analysis

Discharge Calibration is the stage to identify the unknown values of the watershed parameter. In order to approach the desired discharge result, adjustments are made to the parameter values that have been tried many times by trial and error on the Microsoft Excel program (Nurrochmad *at al.*, 998). Therefore, it results in a value that has a relatively small difference between the measured discharge and the calibration result. The Riam Kiwa River discharge data of 2001 was used as observed discharge data. Discharge calibration is calculated by Mock Method. The following are the watershed parameters used in Mock calibration. Parameter form calibration process shown in Table 2.

Table 2. Calibration parameter for Mock method in Tambak Anyat traditional polder

Watershed Parameter	Unit standard	Parameter Value
Watershed area (km ²)	km ²	382
Wet Season Infiltration Coefficient (Cws)		0.450
Dry Season Infiltration Coefficient (Cds)		0.550
Initial Soil Moisture (ISM)	mm	150
Soil Moisture Capacity (SMC)	mm	105
Initial Groundwater Storage (IGWS)	mm	2,800
Groundwater Recession (k)		0.890

The best rate of correlation coefficient (R) is 0.61, and volume error (VE) as the result of this calibration is 3.51% which indicates that the volume error is relatively small between the

discharge level and the calibration results. The difference between the measurable discharge and the calculated discharge from the calibration results can be seen in Figure 6 below.

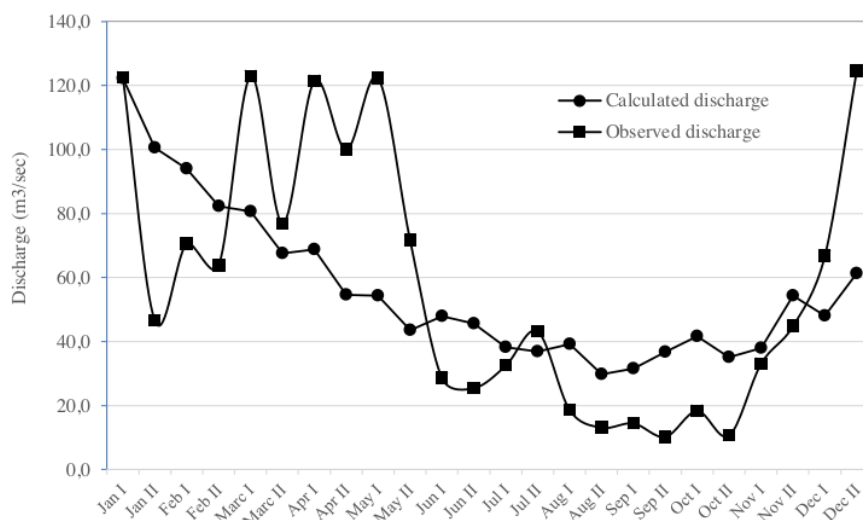

Figure 6. Calibration graph of measured and calculated data in Riam Kiwa river

The average of observed discharge is about 58.4 m³/s, and the average of calculated discharge is about 56.4m³/s. The maximum calculated discharge is 122.2 m³/s in the first half month of January, and the lowest calculated

discharge is 29.8 m³/s in the second period of August.

The second stage of what was calculated was the process of the discharge simulating that entered the polder for 20 years (2001 - 2020) from rain and evapotranspiration data. The

simulation of the discharge entering the polder was analyzed based on the value of the watershed parameters with the watershed areal of the polder as 17.7 km², the data of half-month cumulative rainfall, and the half-month evapotranspiration data. The calculated discharge data is shown in Figure 7.

The simulation of discharge at the Tambak Anyar traditional polder for 20 years was

calculated using the Mock Method. The discharge simulation results show that the maximum availability discharge is 6.91 m³/s in the first half month of January 2020. The minimum availability discharge was 1.19 m³/s in the second half month of October 2015. The average water availability for 20 years is around 1.66 – 5.41 m³/s. Meanwhile, the average water availability was 2.80 m³/s.

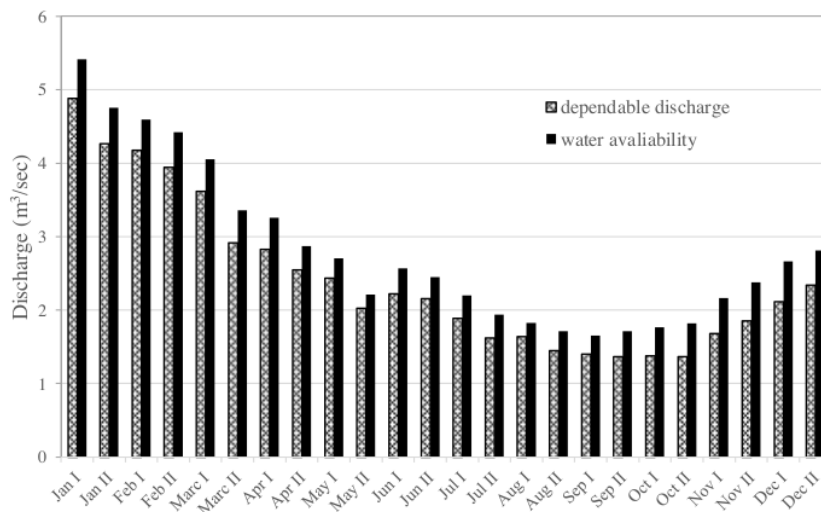

Figure 7. Water availability and dependable discharge in Tambak Anyar traditional polder

The data is sorted using the Weibull Equation in order to determine the magnitude of the dependable discharge with an 80% chance of being fulfilled for agricultural purposes. The maximum Q80% dependable discharge value that can be found in January the 1st period is 4.89 m³/s. At the same time, the minimum Q80% dependable discharge is in the 2nd period of September with a discharge value of 1.37 m³/s. Meanwhile, the average water availability was 2.42 m³/s.

DISCUSSION

The comparison between discharge measurement results in April and May 2021 and average discharge from the simulation results of 2001 - 2020 and dependable discharge for April and May are presented in Table 3 below.

Table 3 Comparison of Average Simulation Discharge and Measured Discharge Data

Month	Year	Discharge (m ³ /s)		Simulation Discharge (m ³ /s)	
		Tambak Anyar	Tambak Anyar	Available discharge (2001 – 2020)	Dependable discharge
April	2021	0.8	0.201	3.06	2.69
May	2021	0.16	0.018	2.46	2.23

Based on Table 3 above, it can be seen that the discharge period in April 2021 for the Tambak Anyar River is 0.8 m³/s, and the Rantau Bujur River discharge is 0.201 m³/s. In contrast, the average discharge from the simulation discharge that enters the Tambak Anyar Polder with a polder area of 1,770 Ha is 3.06 m³/s. The discharge in May 2021 for the Tambak Anyar River is 0.16 m³/s, and the Rantau Bujur River discharge is 0.018 m³/s, with the average simulation discharge in May 2001-2020 is 2.46 m³/s.

Based on this comparison, it can see that the discharge entering the polder is quite large; the capability of Tambak Anyar River as a conveyor channel only can be collected 29.74% from the dependable discharge, while the Rantau Bujur River only can accommodate 7.47% in April. In May, the capability of Tambak Anyar River as a conveyor channel only can collect 7.17% from the dependable discharge, while the Rantau Bujur River only can accommodate 0.81%.

The amount of discharge that enters the polder cannot be supported by the ability of the Tambak Anyar and Rantau Bujur Rivers to accommodate water so that the paddy fields in the Tambak Anyar Polder often overflow caused of excess water. This excess of water caused not only floods that inundated the polder area but also the other areas in Banjar Regency as of the beginning of January 2021. In the area of paddy fields, it is caused crop failure almost every year in the Tambak Anyar polder. This result only based on Mock Model with Riam Kiwa River as observed discharge, calibration model with R as 0.61 and VE as 3.51%.

The amount of water that has access to the polder is not counterbalanced by watergates facilities and infrastructure management. Almost all the watergates in the area are do not function optimally. Poorly maintained embankments also cause incoming water not to be managed optimally in Tambak Anyar's traditional polder. At the polder operational, watergates and embankments is a very important part, especially in the traditional polder, which does not use a pump system.

CONCLUSION

The conclusion of this research, which is based on the analysis in the results and discussion chapter, can be concluded that the maximum average dependable discharge at Tambak Anyar traditional polder is with range 1.37 to 4.89 m³/s and the average dependable discharge as 2.42 m³/s. This result only based on Mock Model with Riam Kiwa River as observed discharge, calibration model with R as 0.61 and VE as 3.51%. In further research, it is necessary to get observed discharge from the river that enters the polder. The amount of this water exceeds the river's conveyor capacity in the polder. The solution to this problem is to manage the watergates and embankment to function the polder in accordance with the development objectives of the polder.

ACKNOWLEDGMENT

This present study was completed with partial funding from University Lambung Mangkurat through "Lecturer Compulsory Research

Program” with contract Number 009.85/UN8.2/PL/2021. We also acknowledge the Hydraulic Laboratory, Faculty of Engineering, Lambung Mangkurat University.

REFERENCES

- Allen, R. G. (1998) “FAO Irrigation and Drainage Paper Crop by,” in.
- Bambang Triadmodjo (2008) *Hidrologi Terapan*. Yogyakarta, Indonesia: Beta Offset.
- Bappeda Kabupaten Banjar (2019) *Profil Kabupaten Banjar, Penyusunan Rencana Terpadu Dan Program Investasi Infrastruktur Jangka Menengah*.
- Bouwer, L. M., Bubeck, P. and Aerts, J. C. J. H. (2010) “Changes in future flood risk due to climate and development in a Dutch polder area,” *Global Environmental Change*, 20(3), pp. 463–471. doi: 10.1016/j.gloenvcha.2010.04.002.
- BPS (2018) *Kecamatan Martapura Timur dalam Angka*.
- Mawandha, H. G., Jayadi, R. and Budi Wignyosukarto (2014) “Hydraulic Analysis of Mini Polder System for Flood Control Purpose,” in. Jogjakarta, Indonesia, pp. 22–23.
- Miliano, B., Saggaff, A. and Hadinata, F. (2020) “Dependable Flow Analysis in Lematang Weir,” 9(04).
- Moerwanto, A. S. et al. (2009) *Pedoman Polder Perkotaan Volume 4: Studi Kasus Banger, Semarang*. Semarang, Indonesia: Badan Litbang PU, Puslitbang SDA, UNESCO-IHE.
- Noor, M., Anwar, K. and Kartiwa, B. (2017) “Sistem Polder untuk Pengembangan Pertanian Berkelanjutan di Lahan Rawa Lebak,” pp. 22–38. Available at: <http://repository.pertanian.go.id/bitstream/handle/123456789/6631/08.sistem.polder.untuk.pengembangan.pertanian.berkelanjutan.di.lahan.rawa.lebak.pdf?sequence=1>.
- Novitasari, N. and Reza Adhi Fajar (2012) “Study of technical and non technical aspects of Tambak Hanyar polder management,” in *International Seminar on University-Based Research for wetland Development*. Banjarmasin, Indonesia, pp. 26–27.
- Nurrochmad, F., Sujono, J. and Damanjaya, D. (1998) “Optimasi Parameter Model Hujan-Aliran Mock dengan Solver,” *Media Teknik*. Yogyakarta, Indonesia: Media Teknik, 2(XX), pp. 58–62.
- PUPR (2018) *Perencanaan Sistem Polder dan Kolam Retensi, Modul Diklat Teknis*. Jakarta, Indonesia. Available at: https://bpsdm.pu.go.id/center/pelatihan/uploads/edok/2018/02/98918_Perencanaan_Sistem_Polder_dan_Kolam_Retensi.pdf.
- SNI 6738 (2015) *Perhitungan debit andalan sungai dengan kurva durasi debit, Bsn*. Available at: <http://sispk.bsn.go.id/SNI/DetailSNI/10264>.
- Sosrodarsono, S. and Kensaku Takeda (2003) *Hidrologi untuk Pengairan*. Jakarta, Indonesia: PT. Prandnya Paramita.
- Suripin (2004) *Sistem Drainase Perkotaan yang berkelanjutan*. Yogyakarta, Indonesia: Andi Offset.
- Wignyosukarto, B., Mawandha, H. G. and Rachmad Jayadi (2015) “Mini Polders, as an Alternative of Flood Management in the Lower Bengawan Solo River,” *Irrigation & Drainage Systems Engineering*, 04(01), pp. 1–6. doi: 10.4172/2168-9768.1000131.

WEM_A_Study_of_Flood_Disaster_Mitigation_It_the_Tambak_...

ORIGINALITY REPORT

6%

SIMILARITY INDEX

5%

INTERNET SOURCES

5%

PUBLICATIONS

%

STUDENT PAPERS

MATCH ALL SOURCES (ONLY SELECTED SOURCE PRINTED)

2%

★ www.dowrodisha.gov.in

Internet Source

Exclude quotes On

Exclude matches Off

Exclude bibliography On