

IoT Based Monitoring and Control System of Siam Banjar Orange Plants using Fuzzy Logic Control

by Muhammad Alkaff

Submission date: 05-Apr-2023 12:03PM (UTC+0700)

Submission ID: 2056344785

File name: A.3.e.3-IoT Based Monitoring and Control System of Siam Banjar Orange Plants using Fuzzy Logic Control.pdf (458.25K)

Word count: 5496

Character count: 27816

IoT Based Monitoring and Control System of Siam Banjar Orange Plants using Fuzzy Logic Control

Muhammad Alkaff¹, Andry Fajar Zulkarnain², Muhammad Iqbal Rizqi³

Department of Information Technology, Faculty of Engineering, Universitas Lambung Mangkurat^{1,2,3}
m.alkaff@ulm.ac.id¹, andry.zulkarnain@ulm.ac.id², 1710817110009@mhs.ulm.ac.id³

Article Info

Article history:

Received Jun 13, 2022

Revised Jun 23, 2022

Accepted Aug 25, 2022

Keywords:

Siam Banjar Oranges

Internet of Things

Fuzzy Logic

Monitoring

Microcontroller

ABSTRACT

South Kalimantan is one of the largest citrus fruit producers in Indonesia. One of the leading citrus fruit commodities in South Kalimantan is the Siam Banjar oranges (*Citrus reticulata*). This study developed a monitoring and control system for Siam Banjar orange plants based on IoT (Internet of Things) and Fuzzy Logic Control. The goal is to determine the performance of the Fuzzy Logic Control method in predicting the time to water plants based on temperature and soil moisture. The prototype comprises a Wemos D1 R1 microcontroller with DHT22 and an FC-28 moisture sensor. Two input parameters, temperature, and soil moisture are utilized in Fuzzy Logic Control calculations. The output is the duration of the watering time in seconds. During testing, the value of the sensor is compared to existing manual instruments. In addition, fuzzy MatLab calculations are compared to the Fuzzy Logic Control method calculations. The FC-28 Soil Moisture sensor and hygrometer had an error rate of 3.2%, while the DHT22 sensor and thermometer had 1%. The Fuzzy Logic Control test for watering using fuzzy calculations in MatLab yielded a 3 percent error rate.

© This work is licensed under a Creative Commons Attribution-ShareAlike 4.0 International License.

Corresponding Author:

Muhammad Alkaff

Department of Information Technology

Faculty of Engineering, Universitas Lambung Mangkurat

Brigjen H. Hasan Basri Street, Kayu Tangi, Banjarmasin 70123, Indonesia

Email: m.alkaff@ulm.ac.id

1. INTRODUCTION

South Kalimantan is a province in Indonesia where the cultivation of Siam Banjar Oranges has a high production rate. The amount produced is constantly above 100 thousand tons yearly and is a leading commodity in the fruit category [1].

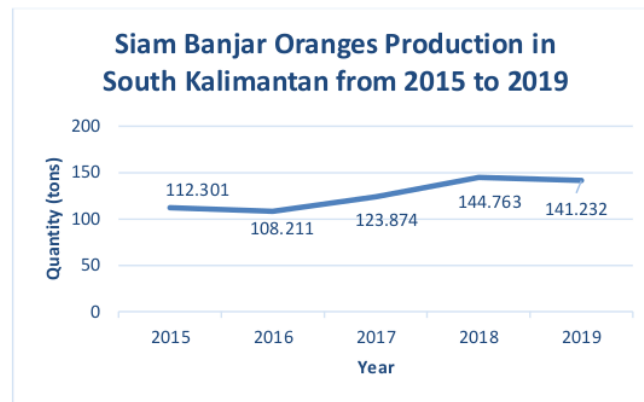

Figure 1. Siam Banjar Oranges Production in South Kalimantan from 2015 to 2019 [1]

Based on Figure 1, the production of Siam Banjar oranges from 2015 to 2016 decreased, then production continued to increase until 2018 and again declined in 2019 after experiencing an increase in production for three years. The fluctuations that occur are caused by farmers' dependence on the seasons in that year. Generally, farmers already have a fixed dose of watering and fertilizing regardless of the season [2], [3]. Therefore, to assist farmers in adjusting the amount of watering and fertilizer to weather conditions, a solution is needed to optimize the dose of fertilizers and watering automatically.

Citrus plants, including Siam Banjar oranges, require direct sunlight (without shade), with temperatures between 13 – 35°C (optimum 22–23°C) and around 70-80% soil moisture. Suitable land depth for citrus is up to 150 cm, with a groundwater depth of approximately 75 cm. The problem with citrus plants is determining how much water is needed depending on the temperature and soil moisture. Conventional watering can result in some plants not getting water intake evenly. Some plants experience excess or lack of water which causes plants to become dry, rot or even die. We proposed a solution to this problem using the IoT (Internet of Things) automatic plant watering system for Siam Banjar oranges based on soil moisture and temperature.

With the assistance of Internet of Things (IoT) technology, a device, namely automatic watering control, is created in tandem with the advancement of current technology, one of which is in the agricultural sector. There is a significant difference between IoT-based sprinklers and conventional watering, where conventional watering can result in uneven water intake for specific plants. In addition to being replaced periodically, the temperature and humidity are not constantly monitored and are only checked periodically. IoT-assisted watering will have several advantages, including timely watering, comprehensive water intake, and watering in accordance with the plant's condition.

With the Internet of Things-based automatic watering control, it will be easier for farmers to monitor plant health. The sensor's data will be transmitted to the server for use in calculating the length of time required for watering. The collected data will be used to generate a graph that depicts the plant's condition, including its temperature and humidity.

Numerous solutions have been developed to help the farmers improve the plant watering process [4]–[6]. Nurhasanah et al. propose implementing an IoT-based agricultural technology innovation to address the problem of a precise watering system for tomato plants [7]. Codeluppi [8] presented low-cost and modular IoT solutions for monitoring and controlling vegetable plants. Several studies recommend a unique solution for every plant and fruit [9]–[11], as every plant and fruit has unique growth requirements, particularly for temperature and soil moisture dependent on the local climate. However, there is still a lack of solutions for controlling and monitoring citrus, specifically Siam Banjar oranges.

This study presents an IoT-based system for monitoring and controlling Siam Banjar oranges. We utilized the Wemos D1 R1 for the microcontroller, the DHT 22 sensor for temperature

monitoring, and the FC28 Soil Moisture Sensor for soil moisture monitoring. The data from the sensors will be sent from the device to the cloud server for calculation using the Fuzzy Logic Control method, which can later be compared to determine which method is more suitable for Wemos D1 R1 when operating an IoT-based plant watering system. In the meantime, the performance of the DHT22 sensor can also be compared to that of its predecessor, the DHT11 sensor. The decision to water the plants will depend on the data obtained from these sensors, which will be subsequently processed and calculated. The cloud server then relayed the analysis results back to the device to activate the watering device for a period based on the value sent from the server.

2. RESEARCH METHOD

2.1 Tools and materials

The tools and materials used in this study are as follows.

Table 1 . Tools and Materials

| | | |
|--------------------------|---|-------------------------------|
| Hardware | 1. Device | Acer E5-476G |
| | 2. Memory | RAM 8GB DDR4 |
| | 3. Processor | Intel Core i5-8250u 3.4GHz |
| | 4. GPU | Nvidia Geforce MX150 2GB DDR5 |
| | 5. Microcontroller | Wemos D1 R1 |
| | 6. Temperature Sensor | DHT22 |
| | 7. Soil Moisture Sensor | FC-28 |
| | 8. Water Pump | Mini DC 5v. Water Pump |
| | 9. Relay | |
| | 10. RTC Module | DS3231 |
| Software | 1. Arduino IDE | |
| | 2. Google Firebase | |
| | 3. Visual Studio Code | |
| | 4. Command Prompt | |
| Research Material | Banjar oranges are 2-3 months old by planted in <i>polybags</i> . | |

2.2 Research Flow

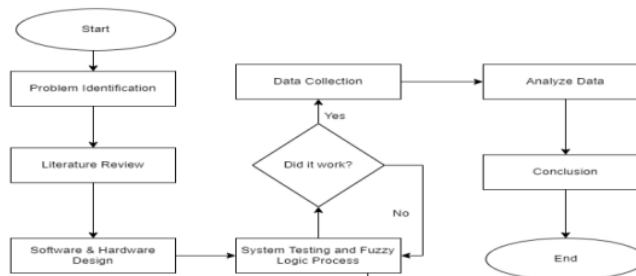

Figure 2. Research Flow

1. Identification of problems

The problem is that farmers still have a dependence on the rainy season to carry out farming activities. So that when the dry season arrives, many farmers suffer losses because the plants they plant lack water, resulting in crop failure [12]. In terms of watering, usually in several cases, the problem in the watering process is related to the right amount of water. Conventional watering can result in some plants not getting water intake evenly, so some plants experience excess or lack of water which causes plants to become dry, decay or even die [13][14].

2. Study of literature
The literature study in this study will be used to explain, predict, and identify phenomena that occur. In addition, a literature study is also helpful for formulating hypotheses, discussing, and providing suggestions or recommendations. The studies used in this research include national and international scientific journals, news, research papers, and books [15].
3. Hardware & Software Design
The hardware design needed to carry out the watering and monitoring process on Siam Banjar oranges plants is the first DHT22 sensor that measures temperature with digital output. FC-28 soil moisture sensor, which is used to measure soil moisture. Relay that functions to control the on or off watering. As well as a 5V DC pump to supply water to plants.
4. Overall Testing of Fuzzy Logic Systems and Processes
The test was carried out by taking temperature and soil moisture data on Siam Banjar oranges plants in the morning and evening and testing fuzzy calculations to determine the watering length. After the data on temperature, soil moisture, and the length of time of watering is obtained, the Wemos microcontroller will send those data directly to the Google Firebase database.
5. Data acquisition
The data that is obtained and used in this study are:
 - Temperature (°C)
 - Humidity (%)Temperature and soil moisture data are variables used as input. Temperature and soil moisture data were obtained from sensors DHT22 and FC-28.
6. Data Processing and Analysis
At this stage, the processing and analysis of the data obtained are carried out. The results from the processing and analysis will be the result of the research carried out in this case, namely the monitoring system and watering plants on the Siam Banjar orange plants.
7. Conclusion
The next stage is drawing conclusions, which will summarise the answers to the problems presented in the research and recommendations to the parties concerned. In addition, some good suggestions will be given to be used as references for further study.

2.3 System Workflow

1. Air temperature & soil moisture will be input which will be sent from the sensor to the device, namely Wemos D1.
2. Based on data obtained from the Indonesian Subtropical Fruit Research Institute, the temperature will be said to be cold if it has a value $< 30^{\circ}$, normal if it has a value between $20^{\circ} - 40^{\circ}$, and hot if it has a value $> 30^{\circ}$ [16].
3. Based on data from the Yogyakarta Agriculture Service, soil moisture is said to be wet if it has a value of $< 80\%$, normal if it is between $70\% - 90\%$, and dry if it is $> 80\%$. [13][14].
4. Wemos will receive temperature & soil moisture data from the FC-28 and DHT22 sensors, and then Wemos will check whether the time is 7 am or 5 pm [17][18].
5. If yes, then the fuzzy logic calculation will be carried out to determine the length of time for watering the plants being studied [19][20].
6. Based on data obtained from the Jogja Agriculture Service, watering will be said to be short if it is worth < 7 seconds, moderate if it is between 5-10 seconds, and long if it is worth > 7 seconds.
7. After the watering time has been determined, the *relay* will be active. It will automatically activate the pump function and the watering process according to the specified time using *fuzzy logic*.

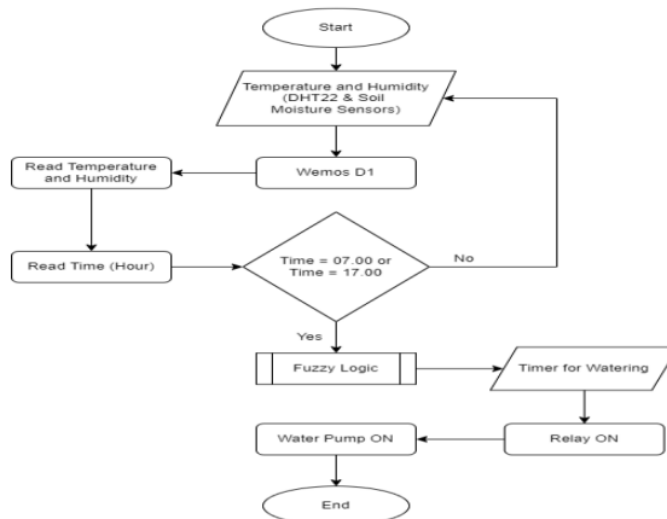

Figure 3 . System Workflow

2.4 Fuzzy Logic Design

IoT-based watering is carried out based on the results of fuzzy logic calculations. In this watering process, the fuzzy logic method is used. The variables used as input are temperature and soil moisture. Furthermore, as the output is the length of time the watering is done.

The process of calculating the fuzzy logic method is carried out using the fuzzification calculation. Fuzzification is a calculation that changes the input from a firm value to a fuzzy value in the form of a fuzzy set with their respective membership functions. In this investigation, two variables were employed: temperature and soil moisture. Each variable possesses a distinct linguistic value. The linguistic value of the temperature variable is cold, normal, and hot. The soil moisture variable has three linguistic values: wet, normal, and dry. Regarding the results of fuzzy calculations, the linguistic value is short, medium, and long, for the duration of the watering variable.

2.5 Monitoring System Design

The readings from the sensor will then be processed and displayed in graphical form. The web monitoring system design uses HTML, Bootstrap, and JavaScript.

2.6 Hardware Design

To make it easier to do the design, the researchers have made a visualization of the wiring design in the Fritzing software. The following displays the component circuit design [21][22].

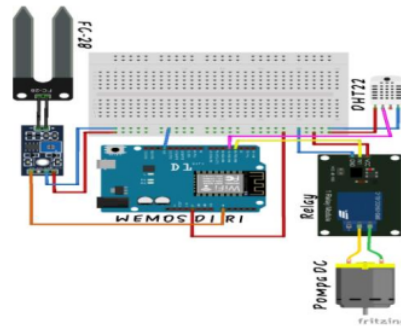

Figure 4. Hardware Circuit Wiring

The sensor's readings will then be processed and represented graphically. HTML, Bootstrap, and JavaScript are used to develop the design of the web monitoring system. In this monitoring system, users can observe the condition of their plants in real-time or directly. Sensor log data, temperature and humidity sensor readings, and fuzzy calculation data are displayed in this monitoring system. Each sensor's reading will be displayed on the dashboard page, while fuzzy calculation data will be displayed on the fuzzy calculation page.

The microcontroller of this IoT monitoring and control system begins by reading the time. The device will automatically water the plants based on the temperature and humidity readings from the DHT22 and FC-28 sensors if the time is 07.00 (7 am) or 17.00 (5 pm). The temperature and humidity measured by the DHT22 and FC-28 sensors serve as inputs for the fuzzy inference procedure. Fuzzification, fuzzy rule, and defuzzification are the processes that are executed along with the output value computed during defuzzification. The output of defuzzification is the amount of time required for watering (seconds). Once the output is obtained, the microcontroller will automatically activate the pump relay.

2.7 Software Design

The software design process starts by writing a line of code on the Arduino IDE software to determine the sensor data parameters used in the Siamese orange plant's watering and monitoring system. Sensor data consists of analog data results from temperature and soil moisture readings. The results of sensor data already in the real-time database will be displayed in a web-based monitoring system. In the monitoring system, users can view sensor data in the form of temperature, soil moisture, and the length of time of watering.

3. RESULTS AND ANALYSIS

In this study, testing was carried out using functional testing and testing the performance of the Internet of Things (IoT) based watering device using the fuzzy logic method. The tests carried out are tool testing and system testing. Testing of tools serves to test whether all equipment can operate normally, while system testing is carried out to test the calculation method of the plant watering system. Then the test results will be entered into a table and compared to find the error value. [23][24].

3.1 System Test

The temperature and soil moisture data obtained in the morning and evening will produce a calculation value using the fuzzy logic method and produce an output value in the time the watering is carried out in seconds (s). The microcontroller's calculations will then be compared to MatLab's calculations. In addition, calculations from the microcontroller will be compared to watering data obtained from interviews with Siam Banjar orange farmers based on fuzzy rules established by those farmers. This obtained table of comparison appears below.

Table 2. System Testing

IoT Based Monitoring and Control System of Siam Banjar Orange Plants using Fuzzy Logic Control, Alkaff

| Date | Time | Input | | Output (seconds) | | | MatLab Error (%) | Field Error (%) |
|-------------------|-------|------------------|--------------|------------------|-----------------|-------|------------------|-----------------|
| | | Temperature (°C) | Humidity (%) | MatLab | Microcontroller | Field | | |
| 7/9/21 | 7:00 | 28.5 | 71 | 4.1 | 4.4 | 5 | 6.8 | 12 |
| | 17:00 | 29.4 | 72 | 4.4 | 4.3 | 5 | 2.3 | 14 |
| 8/9/21 | 7:00 | 29.9 | 75 | 5.1 | 5.3 | 5 | 3.7 | 5.6 |
| | 17:00 | 31.6 | 72 | 4.7 | 4.8 | 5 | 2 | 4 |
| 9/9/21 | 7:00 | 28.4 | 71 | 4.1 | 4.4 | 5 | 6.8 | 12 |
| | 7:00 | 29.9 | 79 | 6.9 | 6.6 | 5 | 4.5 | 24.2 |
| 10/9/21 | 7:00 | 30.2 | 77 | 6 | 6 | 5 | 0 | 16.6 |
| | 17:00 | 31.9 | 79 | 6.9 | 6.6 | 5 | 4.5 | 24.2 |
| | | | | | | | | |
| | | | | | | | | |
| | | | | | | | | |
| 4/10/21 | 7:00 | 28.2 | 79 | 6.5 | 6.4 | 5 | 1.5 | 21.8 |
| | 17:00 | 27.2 | 76 | 5.7 | 5.5 | 5 | 3.6 | 9 |
| 5/10/21 | 7:00 | 28.6 | 78 | 6.4 | 6.4 | 5 | 0 | 21.8 |
| | 17:00 | 30.8 | 79 | 6.9 | 6.6 | 5 | 4.5 | 24.2 |
| 6/10/21 | 7:00 | 30.6 | 76 | 5.7 | 5.5 | 5 | 3.6 | 9 |
| | 17:00 | 28.6 | 75 | 5.4 | 5.5 | 5 | 1.8 | 9 |
| Average Error (%) | | | | | | | 3 | 14 |

In addition, based on information obtained from Siam Banjar orange farmers whom researchers interviewed First, for watering mature Siam Banjar oranges, a table detailing the quantity of water required for mature Siam Banjar oranges is provided.

Table 3. The amount of water needed for watering mature Siam Banjar orange plants

| Watering Parameter | Amount of Water |
|--------------------|-----------------|
| Dry | 1000 ml |
| Normal | 5000 ml |
| Wet | 7000 ml |

Based on the above-obtained watering parameters, the calculation data for the projected watering time for citrus seedlings of the Siam Banjar variety will be utilized in this study. In addition, the error value will be determined by comparing the fuzzy rules derived from data collected from Siam Banjar orange farmers with the results of calculations made by the IoT-based plant watering system.

According to the microcontroller and MatLab estimates, the first day's errors are 30.1°C temperature and 76% soil moisture. Below is the calculated error from the comparison.

$$\begin{aligned}
 Error &= \frac{MatLab - Microcontroller}{Microcontroller} \times 100\% & (1) \\
 &= \frac{5.7 - 5.5}{5.5} \times 100\% \\
 &= \frac{0.2}{5.5} \times 100\% \\
 &= 3.6\%
 \end{aligned}$$

In addition, the calculation's average error can be determined by summing all error values and dividing by the number of tests conducted, yielding the following formula.

$$\begin{aligned}
 \text{Average Error} &= \frac{\Sigma \text{error}}{\Sigma \text{uji coba}} & (2) \\
 &= \frac{181.3}{60} \\
 &= 3\%
 \end{aligned}$$

Based on the *error results* from *fuzzy logic calculations* carried out through the microcontroller and also MatLab, it is found that the *output value* generated from the watering device and MatLab has more or less the *same results*, although it still has an *error* of 3%. However, the resulting *output* is not too far off, so *it can be concluded that the IoT-based plant watering device using fuzzy logic calculations* is feasible to use directly.

3.2 Discussion of Fuzzy Logic Calculations

Fuzzification computations are utilized during the calculation of the fuzzy logic approach. Fuzzification is a calculation that transforms a firm input value into a fuzzy output value in the form of a fuzzy set with its appropriate membership functions. Temperature and humidity factors were utilized in this investigation. Each variable possesses a distinct linguistic value. The linguistic value of the temperature variable is cold, normal, and hot. The humidity variable has three linguistic values: wet, normal, and dry. Regarding the outcomes of fuzzy computations, the variable watering duration has a linguistic significance, namely short, medium, and long.

1. MatLab Calculations

The calculations in this study were used using the MatLab R2019a software. The first step is to set the input, Fuzzy Inference System, and output according to the previously determined variables. The calculation is by using the input on the sensor readings with an example of a temperature of 28.1°C and soil moisture of 71%. The following is the value of the temperature membership.

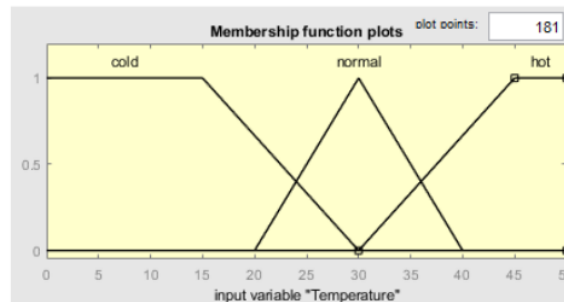

Figure 5. Temperature membership value

Here is how to calculate cold temperature membership. [25][26]

$$\mu_{\text{Cold temperature}} = \frac{(d-x)}{(d-c)} = \frac{(30-28.1)}{(30-15)} = \frac{(1.9)}{(15)} = 0.12$$

From the calculation of cold temperature, the value is 0.12.

The following is a calculation of the normal temperature membership.

$$\mu_{\text{Normal temperature}} = \frac{(x-a)}{(b-a)} = \frac{(28.1-20)}{(30-20)} = \frac{(8.1)}{(10)} = 0.81$$

From the calculation of cold temperature, the value is 0.81.

The following is the value of the soil moisture membership.

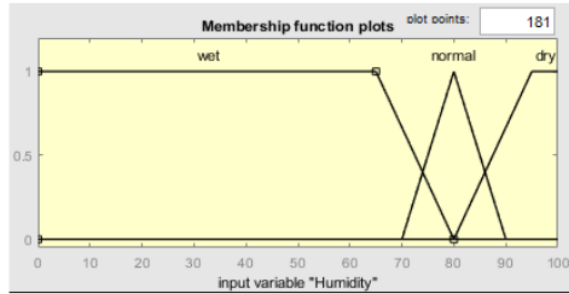

Figure 6. Humidity membership value

Here is how to calculate wet soil moisture membership. [25][26]

$$u_{\text{Wet soil moisture}} = \frac{(d-x)}{(d-c)} = \frac{(80-71)}{(80-65)} = \frac{(9)}{(15)} = 0.6$$

From the calculation of $u_{\text{Wet soil moisture}}$, the value is 0.6.

The following is how to calculate the normal soil moisture membership.

$$u_{\text{Normal soil moisture}} = \frac{(x-a)}{(b-a)} = \frac{(71-70)}{(80-70)} = \frac{(1)}{(10)} = 0.1$$

From the calculation of normal soil moisture, the value obtained is 0.1.

Next, a fuzzy rule is generated by comparing the value of each input's fuzzification. For each rule's value, the fuzzification value of each input is compared, and the MIN function is then used to identify the smallest value from each comparison. The final step is to calculate defuzzification using the Center of Area (CoA) method, which consists of the following calculation formula:

$$\text{Defuzzification (CoA)} = \frac{\sum_{i=1}^n \text{rule}(i) \times \text{CoA}(i) \times L(i)}{\sum_{i=1}^n \text{rule}(i) \times L(i)} \quad (1)$$

$$= \frac{\text{rule}[0][0] \times \text{CoA}(1) \times L(1) + n}{\text{rule}[0][0] \times L(1) + n} \quad (2)$$

$$= \frac{0.12 \times 3.75 \times 3.75 + 0.1 \times 3.75 \times 3.75 + 0.6 \times 3.75 \times 3.75 + 0.1 \times 2.5 \times 7.5}{0.12 \times 3.75 + 0.12 \times 3.75 + 0.6 \times 3.75 + 0.1 \times 2.5}$$

$$= \frac{13.6875}{3.4} = 4.12$$

The following is a Matlab-based proof of calculation. As shown in Figure 7, the length of time required for watering at a temperature of 28.1°C and relative humidity of 71% is 4.12 seconds when calculated.

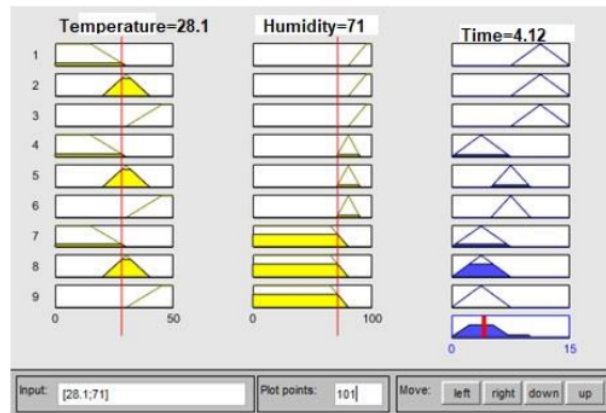

Figure 7. Calculations using Matlab

2. Microcontroller Calculation

First, fuzzify each input. The divisor value of 15 on the cold membership " $cold = (T-30)/15$ " comes from $30 - 15$ on the cold membership, and the divisor value of 10 on the normal membership " $(T-20)/10$ " comes from $30 - 20$ on the normal temperature membership, and the divisor value of 15 on the hot membership " $(temperature-30)/15$ " comes from $45 - 30$ on the hot temperature membership [27].

The divisor value of 15 on wet membership " $(80 - h)/15$ " results from a reduction of $80 - 65$ in wet soil moisture membership, followed by a divisor value of 10 on normal membership " $(h - 70)/10$ " resulting from a reduction of $80-70$ on membership normal soil moisture, and a value of 15 in the dry membership " $(soil moisture - 80)/15$ " resulting from a reduction of $95 - 80$ in the dry soil moisture membership

3. Implementation on Google Firebase

Google Firebase is used as a web server and database server. The web server in this study is used to build a monitoring system that can later assist users in knowing the state of their plants at that time, where the data displayed in real-time is obtained from a database already stored in the Google Firebase database server [22].

In Figure 8, the page displays temperature and humidity sensor values when the last watering. In addition, a graph of temperature and humidity values from the seven most recent irrigations is shown. This page also offers a manual watering control to manually activate or deactivate the watering process and an automatic watering control to set watering hours and minutes.

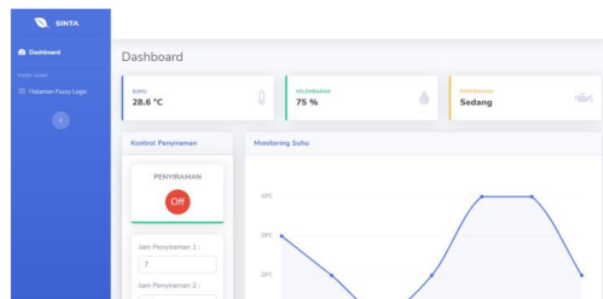

Figure 8. Monitoring System Dashboard

4. Plant Watering Process

The plan watering process is done twice daily, namely at 07.00 and 17.00. The plants are placed inside a polybag on the terrace, which is not exposed to direct sunlight but gets enough heat because the Siam Banjar orange plant still needs hot temperatures to grow well. Besides, the optimum soil moisture of the Siam Banjar orange plant is 70-80% because if the conditions are too humid, it can cause fungal diseases. On the other hand, if the soil moisture is too dry, it can cause many pest attacks.



Figure 9. Comparison of Siam Banjar orange plants

From 4 weeks of research time and data collection, both Siam Banjar orange plants with manual and automatic watering were equally able to grow well. However, automatic watering had a few advantages, whereas Siam Banjar orange plants, which were watered automatically, tended to grow more stable than Siam Banjar orange plants, which were watered manually.

One example is the Siam Banjar orange plant which is watered manually. Sometimes, the leaves wither even though they eventually return to normal. Siam Banjar oranges that are watered automatically have a higher height of ± 5 cm compared to those watered manually and denser leaves. In addition, with an automatic watering device, users will find it easier and more efficient to care for their plants because they can monitor them remotely.

4. CONCLUSION

This study aims to design a monitoring and watering system for Siam Banjar orange plants using the Internet of Things (IoT) and the Fuzzy Logic Control method. Moreover, to evaluate the performance of the Fuzzy Logic Control method in determining watering time based on soil temperature and soil moisture. The following conclusions can be taken from this evidence:

1. The monitoring and watering system for Siam Banjar citrus plants based on the Internet of Things (IoT) using the Fuzzy Logic Control method has been successfully built. The monitoring system is built on a website-based basis using HTML, Bootstrap, and JavaScript and uses a real-time database from Google Firebase. Meanwhile, the development of Internet of Things (IoT) based plant watering uses Wemos D1 R1 as a microcontroller. In addition, there is a DHT22 sensor used as a plant temperature reader and a soil moisture sensor FC-28 used as a plant moisture reader.
2. During the construction of the watering device, the sensors were tested for performance to determine the error percentage of each sensor, and the results were that the sensors worked very well. The first test on the DHT22 sensor has an error of 1%. Furthermore, testing on the FC-28 soil moisture sensor resulted in an error of 3%. In addition to testing the sensor, calculating the Fuzzy Logic Control method on the watering device was also carried out. There are three steps in the Fuzzy Logic Control method: fuzzification, rule creation, and defuzzification. The results of the output obtained will be compared with the output of the calculation results contained in MatLab. From these results, an error of 3% is obtained, meaning that the IoT-based plant watering tool built is feasible to use immediately.

ACKNOWLEDGEMENTS

The researchers would like to thank the Institute for Research and Community Service Universitas Lambung Mangkurat for the funding that has been provided through the Compulsory Research Lecturer Program for the 2022 Fiscal Year with the contract number 024.40/UN8.2/PL/2022. With this funding, this research and publication can be realized.

REFERENCES

- [1] Badan Pusat Statistik, "Statistik Indonesia 2020," Badan Pusat Statistik, Jakarta, 2020.
- [2] A. Groborz and T. Juliszewski, "Comparison of farmers workload by manual and mechanical tasks on family farms," *Annals of Agricultural and Environmental Medicine*, vol. 20, no. 2, 2013.
- [3] J. Muangprathub, N. Boonnam, S. Kajornkasirat, N. Lekbangpong, A. Wanichsombat, and P. Nillaor, "IoT and agriculture data analysis for smart farm," *Comput Electron Agric*, vol. 156, pp. 467–474, 2019.
- [4] C. Cambra, S. Sendra, J. Lloret, and R. Lacuesta, "Smart system for bicarbonate control in irrigation for hydroponic precision farming," *Sensors*, vol. 18, no. 5, p. 1333, 2018.
- [5] S. Rajendrakumar and V. K. Parvati, "Automation of irrigation system through embedded computing technology," in *Proceedings of the 3rd International Conference on Cryptography, Security and Privacy*, 2019, pp. 289–293.
- [6] A. Vij, S. Vijendra, A. Jain, S. Bajaj, A. Bassi, and A. Sharma, "IoT and machine learning approaches for automation of farm irrigation system," *Procedia Computer Science*, vol. 167, pp. 1250–1257, 2020.
- [7] R. Nurhasanah, L. Savina, Z. M. Nata, and I. Zulkhair, "Design and Implementation of IoT based Automated Tomato Watering System Using ESP8266," in *Journal of Physics: Conference Series*, 2021, vol. 1898, no. 1, p. 012041.
- [8] G. Codeluppi, A. Cilfone, L. Davoli, and G. Ferrari, "VegIoT garden: a modular IoT management platform for urban vegetable gardens," in *2019 IEEE International Workshop on Metrology for Agriculture and Forestry (MetroAgriFor)*, 2019, pp. 121–126.
- [9] M. S. Jalpur, M. M. Gedam, R. Lolage, and N. Ansari, "An IoT System Prototype for Implementation of Secure Smart Agriculture," 2022.
- [10] A. Fujii, "Agricultural Application of Web of Things Architecture," *Impact*, vol. 2019, no. 10, pp. 61–63, 2019.
- [11] A. D. J. Carlos *et al.*, "Monitoring system of environmental variables for a strawberry crop using IoT tools," *Procedia Computer Science*, vol. 170, pp. 1083–1089, 2020.
- [12] B. Kusumo and N. Azis, "Rancang Bangun Alat Penyiram Sayuran Hidroponik Menggunakan Arduino Mega 2560," *Jurnal Media Informatika Budidarma*, vol. 5, no. 1, pp. 124–128, 2021.
- [13] R. Tullah, S. Sutarman, and A. H. Setyawan, "Sistem Penyiraman Tanaman Otomatis Berbasis Mikrokontroler Arduino Uno Pada Toko Tanaman Hias Yopi," *Jurnal Sisfotek Global*, vol. 9, no. 1, 2019.
- [14] A. F. Zulkarnain and M. R. Alfarisi, "Sistem Monitoring Tanaman Berbasis Internet of Things IBM Bluemix," *Jurnal Online Sekolah Tinggi Teknologi Mandala*, vol. 14, no. 1, 2019.
- [15] Sugiyono, *Metode Penelitian & Pengembangan*. Bandung: Alfabeta, 2015.
- [16] Balitjestro, "Panduan Budidaya Tanaman Jeruk." <http://balitjestro.litbang.pertanian.go.id/panduan-budidaya-tanaman-jeruk/> (accessed Dec. 22, 2022).
- [17] I. Tulus Pranata, Beni Irawan, "Penerapan Logika Fuzzy Pada Sistem Penyiraman Tanaman Otomatis Berbasis Mikrokontroler," *Jurnal Coding, Sistem Komputer Untan*, vol. 03, no. 2, pp. 11–22, 2015.
- [18] Badan Penyuluhan dan Pengembangan Sumber Daya Manusia Pertanian, "8 Cara Menanam Jeruk dalam Pot," 2019.

- [19] A. Sharma, P. K. Singh, and Y. Kumar, "An integrated fire detection system using IoT and image processing technique for smart cities," *Sustainable Cities and Society*, vol. 61, p. 102332, 2020, doi: <https://doi.org/10.1016/j.scs.2020.102332>.
- [20] M. Sakthimohan, J. Deny, G. Elizabeth Rani, J. Mahendran, J. A. Jasim Ahmed, and M. AzeemAhamed, "IOT based shrewd agronomy method," *Materials Today: Proceedings*, 2020, doi: <https://doi.org/10.1016/j.matpr.2020.11.096>.
- [21] L. Yu, B. Nazir, and Y. Wang, "Intelligent power monitoring of building equipment based on Internet of Things technology," *Computer Communications*, vol. 157, pp. 76–84, 2020, doi: <https://doi.org/10.1016/j.comcom.2020.04.016>.
- [22] A. Alsalemi *et al.*, "Real-time communication network using firebase cloud IoT platform for ECMO simulation," in *2017 IEEE International Conference on Internet of Things (iThings) and IEEE Green Computing and Communications (GreenCom) and IEEE Cyber, Physical and Social Computing (CPSCom) and IEEE Smart Data (SmartData)*, 2017, pp. 178–182.
- [23] S. Zafar, G. Miraj, R. Baloch, D. Murtaza, and K. Arshad, "An IoT based real-time environmental monitoring system using Arduino and cloud service," *Engineering, Technology & Applied Science Research*, vol. 8, no. 4, pp. 3238–3242, 2018.
- [24] A. Tzounis, N. Katsoulas, T. Bartzanas, and C. Kittas, "Internet of Things in agriculture, recent advances and future challenges," *Biosyst Eng*, vol. 164, pp. 31–48, 2017.
- [25] R. S. Krishnan, E. G. Julie, Y. H. Robinson, S. Raja, R. Kumar, and P. H. Thong, "Fuzzy logic based smart irrigation system using internet of things," *Journal of Cleaner Production*, vol. 252, p. 119902, 2020.
- [26] D. Chen, G. Chang, D. Sun, J. Li, J. Jia, and X. Wang, "TRM-IoT: A trust management model based on fuzzy reputation for internet of things," *Computer Science and Information Systems*, vol. 8, no. 4, pp. 1207–1228, 2011.
- [27] T. Listyorini and R. Rahim, "A prototype fire detection implemented using the Internet of Things and fuzzy logic," *World Trans. Eng. Technol. Educ*, vol. 16, no. 1, pp. 42–46, 2018.

IoT Based Monitoring and Control System of Siam Banjar Orange Plants using Fuzzy Logic Control

ORIGINALITY REPORT

15%

SIMILARITY INDEX

13%

INTERNET SOURCES

8%

PUBLICATIONS

%

STUDENT PAPERS

MATCH ALL SOURCES (ONLY SELECTED SOURCE PRINTED)

8%

★ journal.uir.ac.id

Internet Source

Exclude quotes On

Exclude matches Off

Exclude bibliography On

IoT Based Monitoring and Control System of Siam Banjar Orange Plants using Fuzzy Logic Control

GRADEMARK REPORT

FINAL GRADE

/0

GENERAL COMMENTS

Instructor

PAGE 1

PAGE 2

PAGE 3

PAGE 4

PAGE 5

PAGE 6

PAGE 7

PAGE 8

PAGE 9

PAGE 10

PAGE 11

PAGE 12

PAGE 13
