

The effect of the variation of glass thickness and angle tilt on the performance of the double cover solar water collector

by Ahmad Saiful Haqqi

Submission date: 20-Mar-2023 09:39AM (UTC+0700)

Submission ID: 2041178097

File name: madhan_2021_IOP_Conf._Ser._Mater._Sci._Eng._1034_012084_ok.pdf (1.28M)

Word count: 2964

Character count: 14140

PAPER · OPEN ACCESS

The effect of the variation of glass thickness and angle tilt on the performance of the double cover solar water collector

To cite this article: Muhammad Nizar Ramadhan *et al* 2021 *IOP Conf. Ser.: Mater. Sci. Eng.* **1034** 012084

View the [article online](#) for updates and enhancements.



240th ECS Meeting ORLANDO, FL

Orange County Convention Center Oct 10-14, 2021

Abstract submission due: April 9

SUBMIT NOW

The effect of the variation of glass thickness and angle tilt on the performance of the double cover solar water collector

Muhammad Nizar Ramadhan*, Rachmat Subagyo, Muhammad Haris Sa'dillah, Andy Nugraha

Mechanical Engineering Department, Lambung Mangkurat University

Jenderal Achmad Yani 35,5 Ave, Banjarbaru, South Kalimantan 70714, Indonesia

*Email: nizarramadhan@ulm.ac.id

Abstract. The energy crisis occurs because of the high level of dependence on fossil energy sources. The solution to overcome this problem is by utilizing alternative energy. One of the uses of solar energy is the use of solar collectors to heat water. The purpose of this study was to determine the performance of the solar water heater collector. This study used a double cover collector, with variations in glass thickness of 3 mm and 5 mm and a tilt angle of 20° and 30°. The study was conducted from 10:00 Banjarmasin Time to 16:00 Banjarmasin time. In this study, the best results were produced by solar collectors with a variation of glass thickness of 5 mm and an angle of 30° obtained average energy of 129.3 Watt and average efficiency of 48.1% at an average intensity of solar radiation of 497.6 W m⁻². The performance results of 5 mm thickness glass are better than 3 mm thickness glass. In this study, glass with a thickness of 5 mm is more optimal for transmitting received solar radiation and isolating the heat coming out of the collector into the environment.

Keywords: solar water heater, energy losses, useful energy, efficiency

1. Introduction

One of the uses of the solar collector is the water heater solar collector, as seen in Figure 1. The solar collector generally consists of an absorbent plate that has good heat conductivity, where the absorbent plate is connected to pipes that drain the fluid, and one or more covers see-through at the top. Solar radiation energy is converted into heat by an absorbent plate in which the bottom and sides of the collector are isolated. The heat received by the absorbent plate is then transferred to the pipe which carries the liquid. Several attempts were made to improve the performance of solar water heaters, especially on some collector components that affect the collector performance. The effect of glass distance to the absorbent plate has an effect on the plate temperature, which is the warmest received. The use of clear glass with a thickness of 3 mm with a glass distance to the absorbent plate of 20 mm will cause the plate temperature to be higher [1]. The highest efficiency is produced with a plate thickness of 1.2 mm and a distance between the pipelines of 73.6 mm [2].

The effect of radiation absorption on the single and double cover glass on the solar collector on the heat transfer coefficient results in the absorption of solar radiation on the single cover glass



Content from this work may be used under the terms of the [Creative Commons Attribution 3.0 licence](https://creativecommons.org/licenses/by/3.0/). Any further distribution of this work must maintain attribution to the author(s) and the title of the work, journal citation and DOI.

which can increase the temperature by 6oC. And for collectors with double cover glass can increase the absorption of solar radiation by 11oC [3]. The variation of the collector tilt angle of 10o, 20o, and 30o results in the highest collector waste water temperature occurring at the collector tilt angle of 30o, namely 42.8 oC for 1 cover glass, while for 2 cover glass the temperature is 44.8 oC [4].

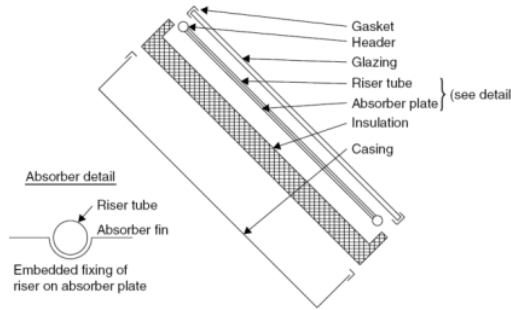

Figure 1. A flat-plate collectors and absorber details [5]

From several previous studies that have been carried out, it is necessary to research other variations of the flat plate solar collector with the use of double collector cover glass (3 mm and 5 mm). The purpose of the double cover glass is so that the heat received from solar radiation is more isolated and does not easily escape into the environment. Besides, there are variations of the collector tilt angle of 20° and 30°, to determine the optimal angle that produces the best collector performance for solar water heater.

1.1 Analysis of heat transfer at solar water heater

Figures 2 (a) and 2 (b) show the differences in heat transfer systems that occur in the two types of solar collectors. The fundamental difference that occurs is in Figure 2b, where the use of a double cover glass will insulate heat leading to the environment better when compared to a collector with a single cover glass.

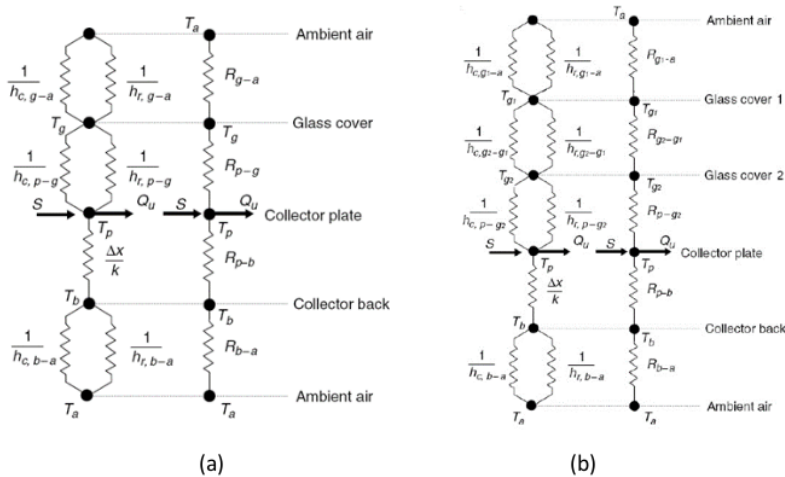

Figure 2. Heat network solar water heater with (a) single cover (b) double cover [5]

Steady-state conditions, heat transfer from the absorber plate to the coverslip equals the energy lost from the cover glass to the environment. Upward heat transfer movement involving the absorber plate and cover glass, occurs by natural convection ($h_{c,p-g}$) and occurs in radiation ($h_{r,p-g}$) to the inner surface of the cover glass. Furthermore, the heat from the inner surface of the cover glass is conducted to the outer surface of the cover glass, which is then transferred to the outside atmosphere by convection ($h_{c,g-a}$) through the wind blowing around the collector and radiation ($h_{r,g-a}$). This heat transfer involving the top of the collector is called the top loss (U_t). In a collector with a well-designed heat transfer system, the bottom loss (U_b) and the edge loss (U_e) are small, so the value can be neglected. [5]

1.2 Useful energy in solar water heater

When solar radiation hits the collector surface, most of it will be absorbed and delivered to the fluid stream and is the energy used to heat the fluid flow. As shown in Figure 3 (a), the absorption of solar radiation corresponds to the value $G_t(\tau\alpha)$.

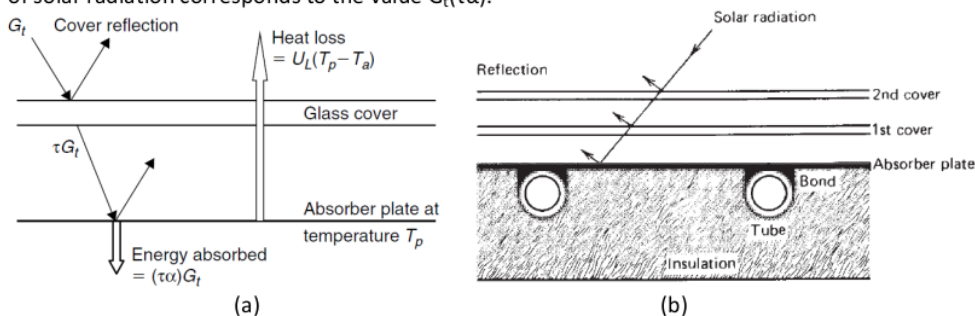

Figure 3. (a) Incoming radiation and heat loss from flat plate collectors [5] (b) Heat transfer process from collector to fluids [6]

Solar radiation that hits the cover glass is forwarded to the absorber plate by convection. The heat absorbed by the absorber plate transfers conduction to the pipeline which is used as useful energy to increase the temperature of the heated water, as seen in Figure 3 (b).

2. Method and material

This study aims to analyze the performance of the collector of solar water heaters with double cover glass (3 mm and 5 mm), as well as variations in the collector's tilt angle of 20° and 30° . The dependent variable is useful energy (Q_u), energy loss (Q_{loss}), and collector efficiency (η). Figure 4 shows the Collector's position on this study.



Figure 4. Collector's position

The test begins by placing the solar water heater collector under direct solar radiation, and positioning it according to the direction of the sun for the Banjarbaru area with a position of 7.95° South Latitude and 112.06° East Longitude for April 1, 2019, to May 1, 2019). The position of the sun will tend to be in the north latitude so that the collector is positioned facing north-south. Data was collected in sunny weather conditions, starting at 10.00 WITA until 16.00 WITA with time intervals every 20 minutes until the data collection time was met for each day. Measured sensor points, among others ambient temperature (T_a), glass cover temperature 1 (T_{g1}), glass cover temperature 2 (T_{g2}), water inlet temperature (T_{in}), absorber plate temperature (T_p), water outlet temperature (T_{out}), and wind speed (v) that measured with anemometer.

3. Result and discussion

Figure 5 shows that the intensity of solar radiation is irregular or fluctuating. This is influenced by several factors including the angle of incidence of the sun. The straighter the incoming sunlight, the higher the total solar radiation received. Besides, the total solar radiation is also affected by atmospheric conditions. Some of the radiation emitted by the sun will be absorbed by the clouds, dust, water vapor, and these gases, and also reflects some of the sun's energy so that it will reduce the amount of energy reaching the earth's surface.

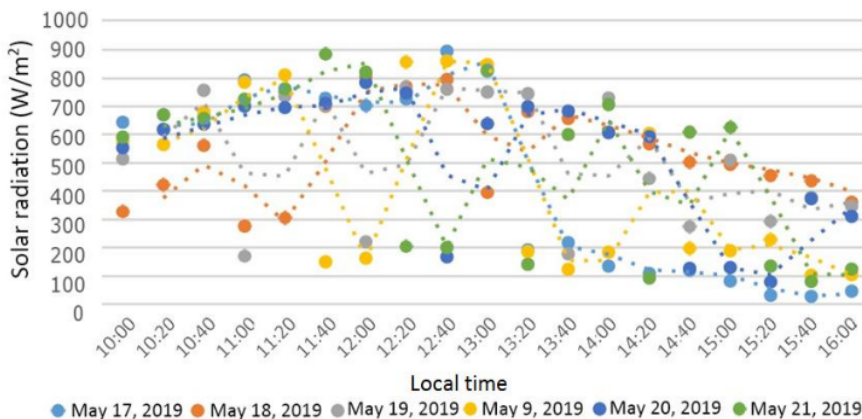

Figure 5. Solar radiation intensity

From Figure 6a and Figure 6b for testing with an angle of 30°, it shows that the total solar radiation recorded by the pyranometer during the test varies considerably, as well as the ambient temperature, glass cover temperature 1, glass cover temperature 2, absorber plate temperature, water inlet temperature. and water outlet temperature. The average solar radiation intensity has the same trendline as the average observed temperature. This means that the amount of energy absorbed by the solar water heater collector corresponds to its energy source, namely solar energy. In testing the variation of glass thickness of 5 mm with an angle of 30°, the average maximum temperature for glass cover 1 (59.66 °C), glass cover 2 (65.4 °C), absorber plate (70.31 °C), water inlet (46.81 °C) and water outlet (53.69 °C). Then in testing the variation of glass thickness 3 mm with an angle of 30°, the average maximum temperature of the observation for glass cover 1 (58.27 °C), glass cover 2 (68.51 °C), absorber plate (63.99 °C), water inlet (47.75 °C) and water outlet (52.77 °C).

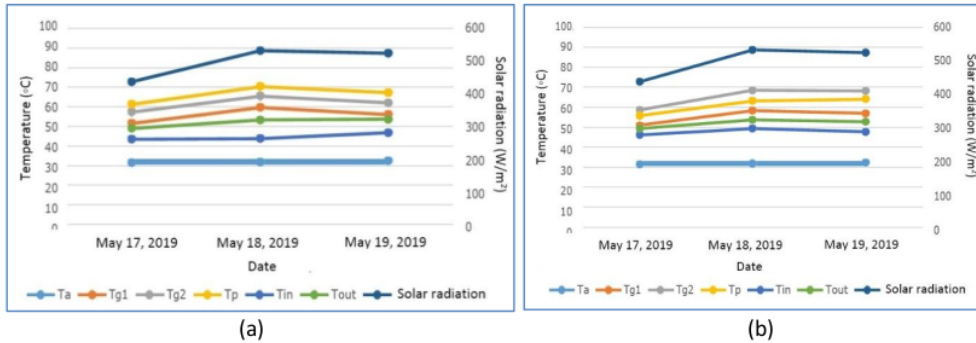

Figure 6. The relationship between average temperature and solar radiation intensity at angle of 30° (a) 5 mm glass; (b) 3 mm glass

From Figure 7a and Figure 7b for testing with an angle of 20°, it shows that the total solar radiation recorded by the pyranometer during the test varies considerably, as well as the ambient temperature, glass cover temperature 1, glass cover temperature 2, absorber plate temperature, water inlet temperature, and water outlet temperature. Figure 7 also shows that the solar water heater collector can absorb all solar energy properly. In testing the thickness of the glass 5 mm with an angle of 20°, the average maximum temperature for glass cover 1 (57.69 °C), glass cover 2 (65.02 °C), absorber plate (70.58 °C), water inlet (48.66 °C) and water outlet (58.47 °C). Then in testing the thickness of the glass 3 mm with an angle of 20°, the average maximum temperature for glass cover 1 (58, 43.9 °C), glass cover 2 (68, 93 °C), absorber plate (69.21 °C), water inlet (49.14 °C) and water outlet (53.41 °C).

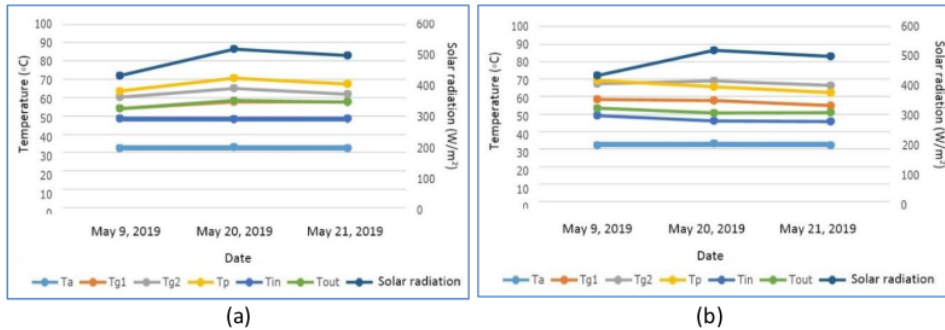

Figure 7. The relationship between average temperature and solar radiation intensity at angle of 20° (a) 5 mm glass; (b) 3 mm glass

Figure 8a and Figure 8b show increasing the intensity of solar radiation is also followed by an increase in collector energy losses. In Figure 8a, with a variation of the thickness of the glass of 5 mm, the average loss of collector energy is the highest, which is 70.5 Watt with an average total solar radiation of 532 W m⁻². Whereas in the thickness variation of 3 mm glass, the highest average collector energy loss is 77.78 Watt, with an average total solar radiation of 523.83 W m⁻². In Figure 8 (b), the variation of glass thickness is 5 mm, the highest average collector energy loss is 78.43 Watt, with an average total solar radiation of 518.6 W m⁻². Whereas in the thickness variation of 3 mm glass, the highest average collector energy loss is 83 Watt at an average total solar radiation of 518.6 W m⁻².

This shows that the relationship is directly proportional to the energy loss (Q_{loss}) and the intensity of solar radiation. The energy losses that occur in the solar water heater cannot be separated from the heat loss that occurs at the top of the collector (U_t). For heat loss at the top of the collector, the involvement of each component of the collector (cover glass temperature and absorber plate temperature) and factors from the environment around the collector (ambient temperature, wind speed, and solar radiation intensity) are the cause of large or small energy loss from the collector.

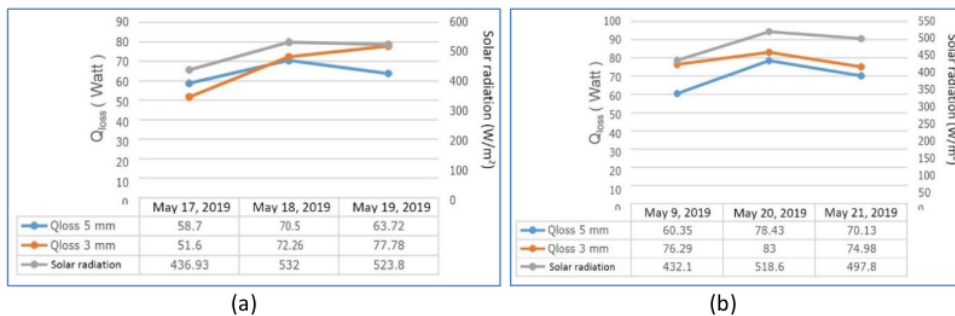

Figure 8. The relationship between average Q_{loss} and solar radiation intensity of 5 mm glass and 3 mm (a) angle of 30° ; (b) angle of 20°

Figure 9a shows in the test using an angle of 30° , and a variation of glass with a thickness of 5 mm, the highest average useful energy is 146.31 Watt at 532 W m^{-2} solar radiation intensity, and 3 mm thick glass 89.33 Watt at 523.83 W m^{-2} solar radiation intensity. In Figure 9 (b) it can be seen the relationship between the average useful energy of the solar collector (Q_{use}) and the intensity of the sun's radiation in the glass thickness variation test of 5 mm and 3 mm with an angle of 20° . The test uses an angle of 20° , and variations of glass with a thickness of 5 mm obtained by the highest average useful energy are 104.5 Watt and 3 mm thick glass is 98.8 Watt at a solar irradiation intensity of 518.6 W m^{-2} . It can be noted that the trendline is directly proportional to the Q_{use} energy and the intensity of solar irradiation, where the higher the intensity of the sun's radiation, the higher the energy value of the benefits obtained.

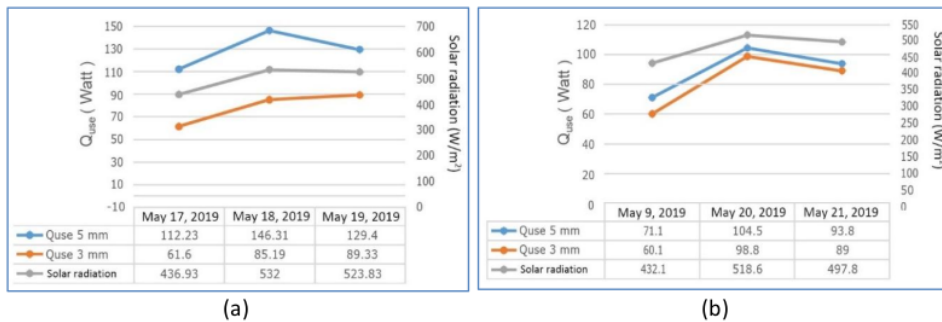

Figure 9. The relationship between average Q_{use} and solar radiation intensity of 5 mm glass and 3 mm (a) angle of 30° ; (b) angle of 20°

In Figure 10a the trendline shows the relationship between the average efficiency of the solar collector (η) and the intensity of solar radiation on the glass thickness variation test of 5 mm and 3 mm with an angle of 30° . In the test using an angle of 30° , and a variation of glass with a thickness of 5 mm, the highest average efficiency is 51% at the intensity of solar radiation of 532 W m^{-2} and 3

mm thick glass produces the highest average efficiency of 31.5% in intensity solar radiation 523.83 W m^{-2} . Figure 10 (b) shows the relationship between the average solar collector efficiency (η) and the intensity of solar radiation in the glass thickness variation test of 5 mm and 3 mm with an angle of 20° . In the test using an angle of 20° , and a variation of glass with a thickness of 5 mm, the highest average efficiency is 37.3%, and 3 mm glass produces the highest average efficiency of 35.2% at the solar radiation intensity of 518.6 W m^{-2} .

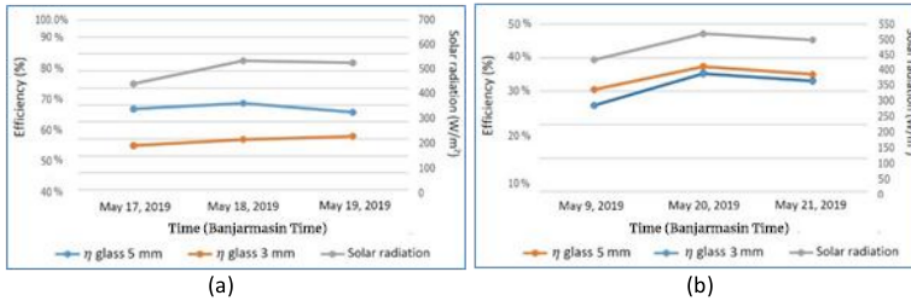

Figure 10. The relationship between average efficiency (η) and solar radiation intensity of 5 mm glass and 3 mm (a) angle of 30° ; (b) angle of 20°

The trendline shows the solar collector efficiency (η) from all tests which is directly proportional to the value of solar radiation intensity. The greater the value of solar radiation intensity, the greater the efficiency value. In addition, the value of useful energy (Q_{use}) also affects efficiency. The greater the value of useful energy (Q_{use}), the greater the resulting efficiency.

4. Conclusion

The best collector performance is obtained at an angle of 30° with a thickness of 5 mm with an average useful energy of 129.3 Watt and an average efficiency of 48.1% at an average solar radiation intensity of 497.6 W m^{-2} . This is better than 3 mm thickness glass with the highest useful energy of 78.7 Watt and an average efficiency of 29.1% at 497.6 W m^{-2} , solar radiation intensity. In this research, the angle 30° produces a better efficiency when compared to the angle of 20° . And the glass cover with a thickness of 5 mm is more optimal in transmitting received solar radiation and isolating the heat coming out of the collector to the environment compared to glass cover with a thickness of 3 mm.

5. References

- [1] Handoyo, E A 2001 *Jurnal Teknik Mesin* **3** (2) 52–56
- [2] Kristanto, P and San, Y K 2001 *Jurnal Teknik Mesin* **3** (2) 47–51
- [3] Akhtar, N and Mullick, S C 2011 *International Journal of Heat and Mass Transfer* **55** 125–132
- [4] Setyadi, U D and Dwiyantoro, B A 2015 *Jurnal Teknik ITS* **4** (1) 31–36
- [5] Kalogirou, S A 2009 *Solar energy engineering: processes and systems* (Oxford: Elsevier, Inc)
- [6] Duffie, J A and Beckman, W A 2013 *Solar engineering of thermal process fourth edition* (New Jersey: John Wiley & Sons, Inc)

The effect of the variation of glass thickness and angle tilt on the performance of the double cover solar water collector

ORIGINALITY REPORT

14%

SIMILARITY INDEX

9%

INTERNET SOURCES

12%

PUBLICATIONS

6%

STUDENT PAPERS

MATCH ALL SOURCES (ONLY SELECTED SOURCE PRINTED)

8%

★ Abdul Ghofur, Mastiadi Tamjidillah, Rachmat Subagyo, Herry Irawansyah, Ibrahim Hasan. "The effect of using jackfruit seed adhesives on the characteristics of corncob waste briquettes", IOP Conference Series: Materials Science and Engineering, 2021

Publication

Exclude quotes On

Exclude matches < 1%

Exclude bibliography On