

# Effects of Eugenol and Cineol Compound on Diffusion Burning Rate Characteristics of Crude Coconut Oil Droplet

*by Ahmad Saiful Haqqi*

---

**Submission date:** 20-Mar-2023 08:14AM (UTC+0700)

**Submission ID:** 2041064534

**File name:** 1.\_Effects\_of\_Eugenol\_and\_Cineol\_6.pdf (662.56K)

**Word count:** 4898

**Character count:** 26547

Research Paper

## Effects of Eugenol and Cineol Compound on Diffusion Burning Rate Characteristics of Crude Coconut Oil Droplet

Helen Riupassa<sup>1</sup>, Suyatno<sup>1</sup>, Hendry Y. Nanlohy<sup>1</sup>, Trismawati<sup>2</sup>, Andi Sanata<sup>3</sup>, Rachmat Subagyo<sup>4</sup>, Satworo Adiwidodo<sup>5</sup>, Muhammad Akhlis Rizza<sup>5</sup>, Masaki Yamaguchi<sup>6</sup>, Takuya Tomidokoro<sup>6</sup>, Selcuk Sarikoc<sup>7</sup>

<sup>1</sup>Department of Mechanical Engineering, Jayapura University of Science and Technology, Jayapura 99351, Indonesia

<sup>2</sup>Department of Industrial Engineering, Panca Marga University, Probolinggo 67271, Indonesia

<sup>3</sup>Department of Mechanical Engineering, University of Jember, East Java 68121, Indonesia

<sup>4</sup>Department of Mechanical Engineering, Lambung Mangkurat University, Banjarmasin 70123, Indonesia

<sup>5</sup>Department of Mechanical Engineering, State Polytechnic of Malang, East Java 65141, Indonesia

<sup>6</sup>Department of Mechanical Engineering, Keio University, Tokyo, 108-8345, Japan

<sup>7</sup>Department of Mechanical Engineering, Amasya University, Amasya 05100, Turkey

[hynanlohy@gmail.com](mailto:hynanlohy@gmail.com)

<https://doi.org/10.31603/ae.8150>



Published by Automotive Laboratory of Universitas Muhammadiyah Magelang collaboration with Association of Indonesian Vocational Educators (AIVE)

### Abstract

#### Article Info

Submitted:

13/11/2022

Revised:

22/01/2023

Accepted:

24/04/2023

Online first:

28/04/2023

The burning rate of coconut oil droplets has been investigated experimentally by adding bio-additives of clove oil and eucalyptus oil. Tests were carried out with single droplets suspended on thermocouples at room atmospheric pressure, and room temperature and ignited with a hot wire. The addition of clove oil and eucalyptus oil as bio-additives into coconut oil was 100 ppm and 300 ppm, respectively. The droplet combustion method was chosen to increase the contact area between the air and fuel so that the reactivity of the fuel molecules increases. The results showed that the eugenol compounds contained in clove oil and cineol compounds in eucalyptus oil were both aromatic, and had an unsymmetrical carbon chain geometry structure. Furthermore, this factor can potentially accelerate the occurrence of effective collisions between fuel molecules. Therefore the fuel is combustible, as evidenced by the increased burning rate, where the results show that without bio-additives, the burning rate of crude coconut oil (CCO) is about 0.7 seconds. These results are 0.15 to 0.2 seconds slower than CCO with bio-additive, which is around 0.55 to 0.6 seconds. Moreover, from the observations, it was found that the highest burning rate was achieved in both bio-additives with a concentration of 300 ppm.

**Keywords:** Droplet combustion; Burning rate; Crude coconut oil; Eugenol; Cineol

### 1. Introduction

Biofuel sourced from crude vegetable oil is one of the alternative energy sources needed to control the growing fuel energy crisis due to increasing industrial activity and the human population [1]-[4]. Previous researchers have applied research using vegetable oils in internal combustion engines [5]-[8]. However, despite many reports showing success in the application of vegetable oil, much scientific information still has not been

revealed [9], [10]. Crude vegetable oils have many complex factors, such as multi-component compounds with different roles like surface active chemicals [11], [12], high oxygen content and poor stability [13], and also have effects in the combustion process [14], [15]. In addition, unlike diesel oil, the high viscosity of vegetable oil makes it difficult to burn under normal conditions [16] but this problem can be overcome by modifying engine components. Furthermore, atomization processes [17], droplet and flame interactions in



This work is licensed under a Creative Commons Attribution-NonCommercial 4.0 International License.

the spray [18], convection flows such as eddies or buoyancy [19], as well as normal gravity conditions such as pressure and temperature [20], and the composition of fuel molecules [21].

On the other hand, previous studies have also used fundamental manner like the suspended single droplet combustion method by utilizing various vegetable oils, including: coconut oil [22], [23], jatropha oil [24], castor oil, sunflower oil, corn oil, palm oil, soybean oil, and glycerol [25], [26]. They found that vegetable oils have two components of carbon chains: fatty acids and glycerol, and they burn at different times, starting with fatty acids and following by glycerol. Moreover, they stated that pure vegetable oil has a long ignition delay resulting in a slower burning rate and a longer burning lifetime [14]. Therefore, overcoming these weaknesses requires additional bio-additives, such as clove oil (CvO) and eucalyptus oil (EO), which improve fuel performance [27].

Unfortunately, the effect of CvO and EO intervention on crude coconut oil (CCO) has not been widely disclosed, especially from a molecular perspective and its impact on fuel performance. CvO contains eugenol compounds, while EO contains cineol compounds, and these are aromatic with bent geometric structures. The presence of aromatic rings potentially increases the reactivity of fuel molecules due to the carbon chain having a planar ring structure conjugated with delocalized pi-electron clouds. The delocalized electrons create a magnetic induced field that can produce attractive interactions between the fuel molecules and potentially change the geometric design of the compounds next to them. Changes in the carbon chain's geometrical structure increase the fuel molecules' reactivity so that they are flammable [28]. Moreover, it is due to several things, including; the distance between the carbon chains and the van der Waals bonds weakening so that the viscosity decreases [29].

The available literature explains the significant role of the aromatic compounds eugenol and cineol on the performance of vegetable oils. Therefore, our present study used CCO mixed with CvO and EO as bio-additive. Crude coconut

oil was chosen because of its abundant availability even though it is composed of saturated fatty acids [30]. Saturated fatty acids tend to be rigid, so their viscosity and flash point are high, potentially hampering and reducing fuel performance [31]. Therefore, the geometric structure and the role of eugenol and cineol compounds (see Figure 1) from clove oil and eucalyptus oil are crucial to reduce viscosity and flash point, thus potentially increasing the burning rate and fuel performance. On the other hand, the use of CvO and EO is often applied in health and cosmetic products. Therefore, using CvO and EO as bio-additives can potentially increase financial income because it can produce other products in the automotive sector.

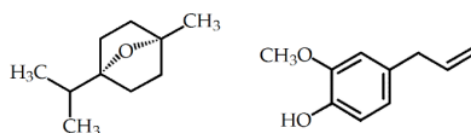

Figure 1. Molecular structure of cineole (left) dan eugenol (right)

## 2. Material and Methods

The current experimental method followed the process of our previous studies by observing the characteristics of combustion through suspended single droplet phenomena [21], as presented in Figure 2. The droplet hung on a thermocouple tip and ignited using an electric coil heater. Single droplet combustion is an attractive analysis, simple, and cost-effective method for combustion characteristics based on fuel properties. The raw material used is CCO, and the bio-additives are clove oil (CvO) and eucalyptus oil (EO). The raw materials were obtained from traditional markets and mixed with bio-additives manually with a composition ratio of 100 ml: 100 ppm and 300 ppm. Mixing CCO and bio-additives aim to cut the production chain through the transesterification process to save the conversion process of vegetable oil into fuel. Furthermore, to determine the composition of the compounds that make up CCO, CvO and EO, the GCMS test was carried out, and the results are presented in Table 1, Table 2, and Table 3.

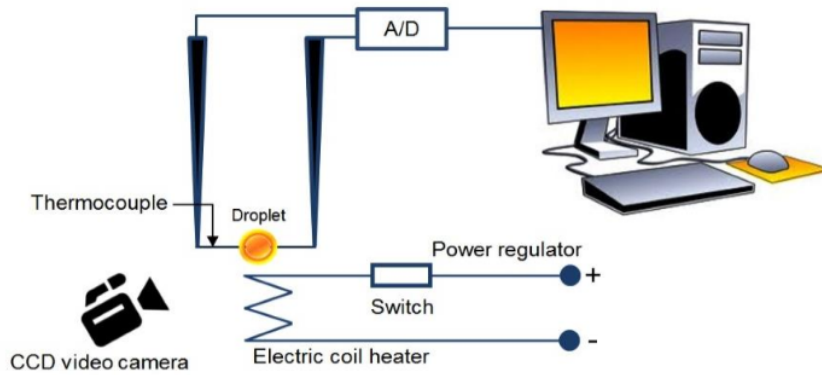

Figure 2. The research scheme [32]

Table 1. Chemical compound of coconut oil

Fatty acids compositions	Formula	Composition %
Caproic	$C_6H_{12}O_2$	0.6
Caprylic	$C_8H_{16}O_2$	8.45
Capric	$C_{10}H_{20}O_2$	6.1
Lauric	$C_{12}H_{24}O_2$	31.43
Myristic	$C_{14}H_{28}O_2$	18.45
Palmitic	$C_{16}H_{32}O_2$	8.4
Stearic	$C_{18}H_{36}O_2$	1.65
Oleic	$C_{18}H_{34}O_2$	5.7
Linoleic	$C_{18}H_{32}O_2$	1.4
Linolenic	$C_{18}H_{30}O_2$	0.05

Table 2. Chemical compound of eucalyptus oil

Carbon chain composition	Formula	Composition %
1,8-Cineole	$C_{10}H_{18}O$	65.94
$\gamma$ -Terpinene	$C_{10}H_{16}$	7.37
Trans-Caryophyllene	$C_{15}H_{24}$	6.31
$\alpha$ -Terpinolene	$C_{10}H_{16}$	5.9
3-Cyclohexene	$C_{10}H_{18}$	5.85
$\alpha$ -Humulene	$C_{15}H_{24}$	4.11
Linalool	$C_{10}H_{18}$	2.57
$\alpha$ -Eudesmol	$C_{15}H_{26}$	1.95

Table 3. The chemical compound of clove oil

Carbon chain composition	Formula	Composition %
Eugenol	$C_{10}H_{12}O_2$	81.2
Caryophyllene	$C_{15}H_{24}$	16.42
Humulene	$C_{15}H_{24}$	1.52
Trimetoksiasetofenon	$C_{18}H_{30}$	0.53
Caryophyllene oxide	$C_{15}H_{24}O$	0.33

### 3. Results and Discussion

In this study, we observed the characteristics of the diffusion-burning rate of CCO with the addition of clove oil and eucalyptus oil, which aims to determine the effect of aromatic eugenol and cineol compounds on fuel performance.

Figure 3 shows the molecular interaction between aromatic eugenol and cineol compounds with the carbon chain of CCO triglycerides. The figure shows that the two aromatic compounds have different roles and influences on the combustion characteristics of CCO.

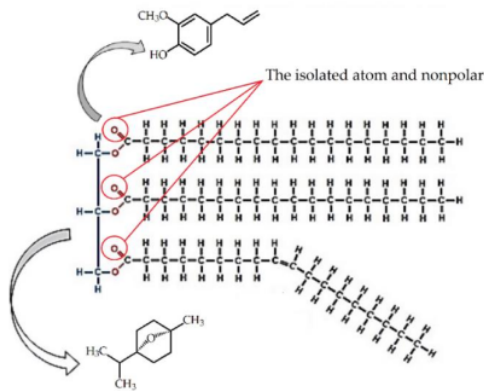

**Figure 3.** Molecular interaction between triglyceride of CCO with aromatic compounds of CvO and EO

The hydroxyl groups in cineol compounds can produce attractive interactions with the oxygen atoms in the triglyceride carbon chains, where the oxygen atoms are isolated and nonpolar. This analysis is possible because Table 2 shows that most of the composition of eucalyptus oil is cineole, which is equal to 65.41%. The formation of H<sub>2</sub>O molecules has the potential to cause a natural transesterification process so that the carboxyl group on the triglyceride carbon chain breaks and separates from the fatty acids. This analysis follows previous studies, which used crude jatropha oil droplet fuel without additives but underwent a preheating process to produce hot steam in the form of H<sub>2</sub>O molecules, which contribute to breaking the carboxyl group from fatty acids [33], [34].

Moreover, when the fuel is reused again, the heating process must continuously be repeated to reduce its viscosity, so it takes a lot of time and money. On the other hand, the presence of eugenol compounds that produce new bonds that can potentially increase the mass and length of the carbon chain of CCO. This impact is that the distance between the fuel molecules becomes closer so possibility for an effective collision is substantial. This phenomenon could increase the reactivity of the material molecules so that they are flammable and the burning rate of diffusion increases. Figure 4 shows that the CCO fuel mixture achieves the fastest burning rate with 300 ppm of EO, followed by CCO with 100 ppm of EO, and the last is CCO without EO. These results indicate that eucalyptus oil is suitable as a bio additive because it has succeeded in increasing

fuel performance, proven by the increasing combustion rate. The presence of the hydroxyl group in the eugenol compound plays a significant role in this result as presented in Figure 3, where, the interaction between the hydroxyl group of the eugenol compound and the oxygen atom present in the carboxyl group of CCO. This interaction produces low van der Waals bonds that can increase the reactivity of fuel molecules.

Meanwhile, from Figure 4, it can also be seen that immediately after burning, around 0.1 seconds, there is a surge in energy marked by an increase in the combustion rate. This phenomenon also applies to the burning of CCO with CvO (see Figure 6) and CCO with CvO and EO (see Figure 7). This is due to the release of energy absorbed by the droplets during the heating and ignition process. This phenomenon also indicates that the particles escaped through the droplet walls, accompanied by a decrease in the viscosity and density of the fuel. This analysis complies with the results of previous studies on the presence of satellite particles trying to penetrate the droplet wall boundary layers resulting in an explosion as indicated by a sudden increase in burning rate [35]. Moreover, it can be seen that the energy surge occurred without being accompanied by a micro explosion, whereas for CCO with bio-additives, it happened faster, around 0.1 seconds. In contrast, CCO without bio-additives was seen slower, namely about 0.15 seconds. In general, it is also seen that the combustion rates of the three fuels coincide with high volatility and highly fluctuating combustion rates confirming the phenomenon.

Moreover, it was also shown by the emergence of micro explosions in CCO fuel with bio-additives, which occurred at different times and

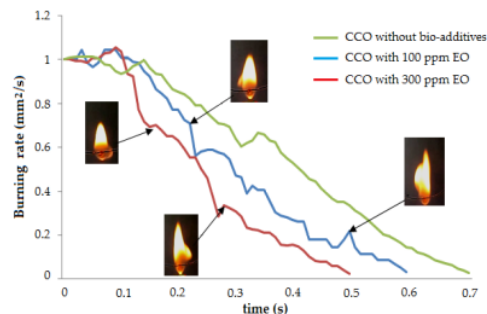

**Figure 4.** Burning rate evolutions of CCO and EO

burning rates. The asymmetrical shape of the fire shows this micro-explosion phenomenon and indicates that fuel molecules have high reactivity [36], one reason being the presence of bio-additives in CCO. This analysis is possible because the presence of eugenol and cineol compounds can increase the effective collision between fuel molecules caused by three factors: the increase in the mass and length of the carbon chain and the closer the distance between the fuel molecules. This analysis follows previous research using kerosene, coconut oil with areca nut extract, and liquid metal [27], [37]. Furthermore, they found that volatility due to the satellite particles is indicated by the appearance of a micro-explosion [25], [35].

On the other hand, when compared with eugenol compounds, cineol has a different role in fuel performance. Based on the structure and molecular composition of the cineol compound, it can be seen that the chances of molecular bonding with the triglyceride carbon chain of CCOI are complicated. This analysis is possible because, from Table 1 and Table 3, it can be seen that the majority of fatty acid compounds contained in CCO and EO are stable and saturated. Furthermore, the durable and watery nature of the EO compound has the potential to change the geometry of the CCO carbon chain. The analysis makes sense because when the cineol and the CCO fatty acid are close together, it can generate a magnetic field induction resulting in an electromagnetic force that causes an attractive pressure and repels the fuel molecules. This factor can change the geometric structure of the CCO carbon chains, whereby the infiltration of cineol compounds between CCO glycerides, a bulky system, is formed, causing the distance between the fatty acid carbon chains to widen.

Furthermore, when the distance between the carbon chains gets wider and farther (see Figure 5),

the van der Waals bonds weaken, and the viscosity decreases, causing the fuel to burn quickly and the diffusion burning rate to increase. This analysis is clarified from the results of the combustion test data (see Figure 6). Moreover, it is also per the results of our previous study using a mixture of crude jatropha oil and liquid catalyst, which are discussed from different points of view [34].

From Figure 6, it can be seen that CCO achieves the fastest burning rate with 300 ppm CvO, and then CCO with 100 ppm CvO and the slowest is CCO without CvO. These results prove that the presence of cineol compounds in CCO can increase the reactivity of fuel molecules to affect the fuel-burning rate positively. In addition, for CCO fuel with 300 ppm of CvO, it is shown that there is an increase in the burning rate of 0.1 mm<sup>2</sup>/s shortly after the fuel burns. This phenomenon shows that energy absorption occurs at the beginning of fuel ignition and is followed by a rapid release of energy, which is about 0.55 s faster when compared to CCO with 100 ppm CvO around 0.6 s and CCO without CvO about 0.7 s. In addition, it is generally seen that the increase in the burning rate occurs in both fuels with additives at different times. This phenomenon is because the fuels are composed of multicomponent compounds (see Table 1 and Table 2), and each blend has other properties and flash points. In addition, these results also indicate that 300 ppm CvO is the best composition as a bio-additive to be added to CCO compared to 100 ppm.

Moreover, for CCO with 100 ppm CvO, we can see that the burning rate is slower, which indicates that the practical collision between the fuel molecules does not occur optimally. This phenomenon is because the amount of bio-additive mass content in the CCO is insufficient to produce an optimal contact distance between fuel

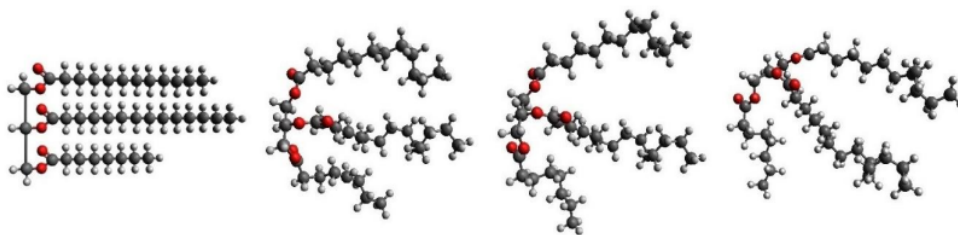

Figure 5. Triglyceride chain evolution due to the molecular interaction with eugenol. Adopted from [26]

molecules. This analysis is possible and follows previous research [21] on the effect of bio-additives on the burning of crude vegetable oil, which is discussed from different perspectives.

To reveal other effects and phenomena of the eugenol and cineol compounds, CCO is mixed with EO and CvO. Figure 7 shows that, in general, adding bio-additives has the same effect as the two previous samples. It can be seen that for CCO with bio-additives, there is a sudden increase in combustion rate at the start of combustion. Whereas for CCO without bio-additives, there was an increase in the initial combustion rate but slower than CCO with bio-additives. These results indicate that bio-additives weakened the CCO triglyceride carbon chain, so energy release occurs faster than CCO without bio-additives. From Figure 7, it can be seen that there was an increase in the burning rate, especially for bio-additives with 300 ppm, which is around 0.47 seconds, faster than the CCO with CvO sample and the CCO with EO sample. On the other hand, for a mixture of 100 bio-additives and pure CCO oil, the burning rate appears to be the same. Which is about 0.5 for 100 ppm and 0.7 for CCO, and this result has the same phenomenon in the two previous samples, namely the CCO sample with CvO and sample CCO with EO. These results indi-

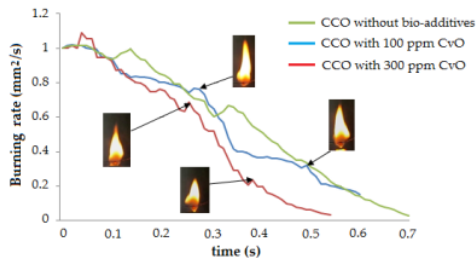

Figure 6. Burning rate evolution of CCO and CvO

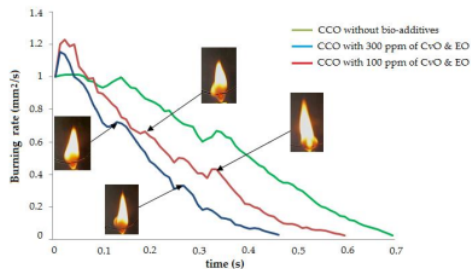

Figure 7. Burning rate evolutions of CCO with CvO and EO

cate that at 300 ppm, the fatty acid compounds CCO, eugenol, and cineol are in ideal conditions to interact. This phenomenon suggests that the fuel molecules have an effective collision distance due to the presence and role of cineol compounds. Meanwhile, the van der Waals forces between the carbon chains are at their weakest due to the role and presence of eugenol compounds.

#### 4. Conclusion

Experimental study about the diffusion burning rate characteristics of CCO droplet with and without bio-additives from clove oil and eucalyptus oil resulted in several scientific findings, i.e.;

- a. Cineol compounds play a role in increasing the effective distance between fuel molecules. In contrast, the hydroxyl group in eugenol compounds acts as a hydrogen acceptor to break the hydroxyl groups of fatty acids to present a natural transesterification process.
- b. Even though coconut oil is saturated and rigid, thus the cineol and eugenol compounds manage to weaken the van der Waals bonds between carbon chains. Therefore, the reactivity of the fuel molecules increases due to the bulky geometry of the triglyceride structure.
- c. With a better burning rate performance than CCO, clove oil and eucalyptus oil can be an alternative for bio-additives to meet fuel needs. In addition, by eliminating the transesterification and pre-heating processes, using eucalyptus oil and clove oil as bio-additives can save energy and production costs.
- d. Molecular interactions, total mass, carbon chain length, and dipole moments in fuel molecules can affect flash point, calorific value, viscosity, and density. In addition, the role of eugenol and cineol compounds in the rate of reduction in fuel mass is also an important part that must be disclosed; therefore, it is necessary to carry out further research on the characterization and physicochemical properties of CCO with a mixture of CvO and EO.

#### Acknowledgements

This article is one of the output of the National Competitive Basic Research (PDKN) grant funded

by the Ministry of Education, Culture, Research, and Technology of the Republic of Indonesia with research contract number 057/LPPM-USTJ/P/VI/2022. The authors thank the fuel and combustion engineering laboratory of Jayapura University of Science and Technology for its research equipment, students, and laboratory assistants who have assisted in the data collection process. We also appreciate the laboratory assistants from the Integrated Laboratory of the State University of Malang for their assistance in collecting data on the composition of CCO, CvO, and EO.

### 1 Author's Declaration

#### Authors' contributions and responsibilities

The authors made substantial contributions to the conception and design of the study. The authors took responsibility for data analysis, interpretation and discussion of results. The authors read and approved the final manuscript.

#### Funding

The Ministry of Education, Culture, Research, and Technology of the Republic of Indonesia with research contract number 057/LPPM-USTJ/P/VI/2022.

### 1 Availability of data and materials

All data are available from the authors.

#### Competing interests

The authors declare no competing interest.

#### Additional information

No additional information from the authors.

### References

- [1] S. Chen, A. Kharrazi, S. Liang, B. D. Fath, M. Lenzen, and J. Yan, "Advanced approaches and applications of energy footprints toward the promotion of global sustainability," *Applied Energy*, vol. 261, p. 114415, Mar. 2020, doi: 10.1016/j.apenergy.2019.114415.
- [2] M. Setiyo, "Alternative fuels for transportation sector in Indonesia," *Mechanical Engineering for Society and Industry*, vol. 2, no. 1, pp. 1–6, 2022. doi: 10.31603/mesi.6850.
- [3] A. Kolakoti, A. V. Kumar, R. Metta, M. Setiyo, and M. L. Rochman, "Experimental studies on in-cylinder combustion, exergy performance, and exhaust emission in a Compression Ignition engine fuelled with neat biodiesels," *Indonesian Journal of Science and Technology*, vol. 7, no. 2, pp. 219–236, 2022. doi: 10.17509/ijost.v7i2.49680.
- [4] A. Sule, Z. A. Latiff, M. A. Abbas, I. Veza, and A. C. Opia, "Recent Advances in Diesel-Biodiesel Blended with Nano-Additive as Fuel in Diesel Engines: A Detailed Review," *Automotive Experiences*, vol. 5, no. 2, pp. 182–216, 2022, doi: 10.31603/ae.6352.
- [5] R. A. Alenezi, Erdiwansyah, R. Mamat, A. M. Norkhizan, and G. Najafi, "The effect of fusel-biodiesel blends on the emissions and performance of a single cylinder diesel engine," *Fuel*, vol. 279, no. X, 2020, doi: 10.1016/j.fuel.2020.118438.
- [6] K. Han, Q. Lin, and M. Liu, "Experimental study on the micro-explosion characteristics of biodiesel/1-pentanol and biodiesel/methanol blended droplets," *Renewable Energy*, vol. 196, pp. 261–277, Aug. 2022, doi: 10.1016/j.renene.2022.06.104.
- [7] A. Kolakoti, M. Setiyo, and M. L. Rochman, "A Green Heterogeneous Catalyst Production and Characterization for Biodiesel Production using RSM and ANN Approach," *International Journal of Renewable Energy Development*, vol. 11, no. 3, pp. 703–712, 2022, doi: 10.14710/ijred.2022.43627.
- [8] S. Supriyadi, P. Purwanto, D. D. Anggoro, and H. Hermawan, "The Effects of Sodium Hydroxide (NaOH) Concentration and Reaction Temperature on The Properties of Biodiesel from Philippine Tung (Reutealis Trisperma) Seeds," *Automotive Experiences*, vol. 5, no. 1, pp. 57–67, 2022, doi: 10.31603/ae.5986.
- [9] H. Y. Nanlohy, H. Riupassa, and M. Yamaguchi, "Performance and Emissions Analysis of BE85-Gasoline Blends on Spark Ignition Engine," *Automotive Experiences*, vol. 5, no. 1, pp. 40–48, 2022, doi: 10.31603/ae.6116.
- [10] S. S. Sazhin, "Modelling of fuel droplet heating and evaporation: Recent results and unsolved problems," *Fuel*, vol. 196, pp. 69–101, 2017, doi: 10.1016/j.fuel.2017.01.048.
- [11] H. Y. Nanlohy and Trismawati, "The role of fatty acid of Morinda citrifolia oil as surface-active chemicals on the deinking process of waste paper," *Materialia*, vol. 23, p. 101436, Jun. 2022, doi: 10.1016/j.mtl.2022.101436.
- [12] A. Kolakoti, B. Prasadarao, K. Satyanarayana, M. Setiyo, H. Köten, and M. Raghu,



- “Elemental, Thermal and Physicochemical Investigation of Novel Biodiesel from *Wodyetia bifurcata* and Its Properties Optimization using Artificial Neural Network (ANN),” *Automotive Experiences*, vol. 5, no. 1, pp. 3–15, 2022, doi: 10.31603/ae.6171.
- [13] I. C. Setiawan and M. Setiyo, “Renewable and Sustainable Green Diesel (D100) for Achieving Net Zero Emission in Indonesia Transportation Sector,” *Automotive Experiences*, vol. 5, no. 1, pp. 1–2, 2022. doi: 10.31603/ae.6895.
- [14] Á. Muelas, P. Remacha, and J. Ballester, “Droplet combustion and sooting characteristics of UCO biodiesel, heating oil and their mixtures under realistic conditions,” *Combustion and Flame*, vol. 203, pp. 190–203, 2019, doi: 10.1016/j.combustflame.2019.02.014.
- [15] M. Setiyo, D. Yuvenda, and O. D. Samuel, “The Concise Latest Report on the Advantages and Disadvantages of Pure Biodiesel (B100) on Engine Performance: Literature Review and Bibliometric Analysis,” *Indonesian Journal of Science and Technology*, vol. 6, no. 3, pp. 469–490, 2021, doi: 10.17509/ijost.v6i3.38430.
- [16] Y. Xu, I. Keresztes, A. M. Condo, D. Phillips, P. Pepiot, and C. T. Avedisian, “Droplet combustion characteristics of algae-derived renewable diesel, conventional #2 diesel, and their mixtures,” *Fuel*, vol. 167, pp. 295–305, 2016, doi: 10.1016/j.fuel.2015.11.036.
- [17] R. Kale and R. Banerjee, “Understanding spray and atomization characteristics of butanol isomers and isooctane under engine like hot injector body conditions,” *Fuel*, vol. 237, pp. 191–201, Feb. 2019, doi: 10.1016/J.FUEL.2018.09.142.
- [18] H. Aljabri, X. Liu, and Al-lehaibi, “Fuel flexibility potential for isobaric combustion in a compression ignition engine: A computational study,” *Fuel*, vol. 316, p. 123281, May 2022, doi: 10.1016/J.FUEL.2022.123281.
- [19] Y. C. Liu, Y. Xu, M. C. Hicks, and C. T. Avedisian, “Comprehensive study of initial diameter effects and other observations on convection-free droplet combustion in the standard atmosphere for n-heptane, n-octane, and n-decane,” *Combustion and Flame*, vol. 171, pp. 27–41, 2016, doi: 10.1016/j.combustflame.2016.05.013.
- [20] M. Plank, G. Wachtmeister, K. Thuneke, E. Remmele, and P. Emberger, “Effect of fatty acid composition on ignition behavior of straight vegetable oils measured in a constant volume combustion chamber apparatus,” *Fuel*, vol. 207, pp. 293–301, 2017, doi: 10.1016/j.fuel.2017.06.089.
- [21] H. Y. Nanlohy, I. N. G. Wardana, M. Yamaguchi, and T. Ueda, “The role of rhodium sulfate on the bond angles of triglyceride molecules and their effect on the combustion characteristics of crude jatropha oil droplets,” *Fuel*, vol. 279, p. 118373, 2020, doi: 10.1016/j.fuel.2020.118373.
- [22] E. Marlina, M. Basjir, and R. D. Purwati, “The Response of Adding Nanocarbon to the Combustion Characteristic of Crude Coconut Oil (CCO) Droplets,” *Automotive Experiences*, vol. 5, no. 1, pp. 68–74, 2022, doi: 10.31603/ae.4954.
- [23] E. Marlina, M. Basjir, M. Ichyanagi, T. Suzuki, G. J. Gotama, and W. Anggono, “The Role of Eucalyptus Oil in Crude Palm Oil As Biodiesel Fuel,” *Automotive Experiences*, vol. 3, no. 1, pp. 33–38, 2020, doi: 10.31603/ae.v3i1.3257.
- [24] H. Y. Nanlohy, I. N. G. Wardana, N. Hamidi, and L. Yuliaty, “Combustion characteristics of crude jatropha oil droplets using rhodium liquid as a homogeneous combustion catalyst,” in *IOP Conference Series: Materials Science and Engineering*, 2018, vol. 299, no. 1, p. 12090. doi: 10.1088/1757-899X/299/1/012090.
- [25] X. Wang, M. Dai, J. Yan, C. Chen, G. Jiang, and J. Zhang, “Experimental investigation on the evaporation and micro-explosion mechanism of jatropha vegetable oil (JVO) droplets,” *Fuel*, vol. 258, no. August, p. 115941, 2019, doi: 10.1016/j.fuel.2019.115941.
- [26] H. Y. Nanlohy, I. N. G. Wardana, N. Hamidi, L. Yuliaty, and T. Ueda, “The effect of Rh<sup>3+</sup> catalyst on the combustion characteristics of crude vegetable oil droplets,” *Fuel*, vol. 220, 2018, doi: 10.1016/j.fuel.2018.02.001.
- [27] Wardoyo, A. S. Widodo, W. Wijayanti, and I. N. G. Wardana, “The Role of Areca catechu Extract on Decreasing Viscosity of Vegetable

- Oils," *Scientific World Journal*, vol. 2021, 2021, doi: 10.1155/2021/8827427.
- [28] Suyatno, H. Riupassa, S. Marianingsih, and H. Y. Nanlohy, "Characteristics of SI engine fueled with BE50-Isocetane blends with different ignition timings," *Heliyon*, vol. 9, no. 1, p. e12922, Jan. 2023, doi: 10.1016/J.HELIYON.2023.E12922.
- [29] H. Y. Nanlohy, H. Riupassa, T. Trismawati, and M. S. Panithasan, "Gasohol Engine Performance with Various Ignition Timing," *Journal of Mechanical Engineering Science and Technology (JMEST)*, vol. 6, no. 1, p. 48, 2022, doi: 10.17977/um016v6i12022p048.
- [30] P. Sakthivel, K. A. Subramanian, and R. Mathai, "Experimental study on unregulated emission characteristics of a two-wheeler with ethanol-gasoline blends (E0 to E50)," *Fuel*, vol. 262, no. August 2019, p. 116504, 2020, doi: 10.1016/j.fuel.2019.116504.
- [31] Z. Liu, P. Sun, Y. Du, X. Yu, W. Dong, and J. Zhou, "Improvement of combustion and emission by combined combustion of ethanol premix and gasoline direct injection in SI engine," *Fuel*, vol. 292, no. November 2020, p. 120403, 2021, doi: 10.1016/j.fuel.2021.120403.
- [32] H. Riupassa, Trismawati, and H. Y. Nanlohy, "The Effect of Graphene Oxide Nanoparticles as a Metal Based Catalyst on the Ignition Characteristics of Waste Plastic Oil," *AIP Conference Proceedings*, vol. 2440, no. Icmen 2021, pp. 1–9, 2022, doi: 10.1063/5.0075009.
- [33] P. Pradhan, H. Raheman, and D. Padhee, "Combustion and performance of a diesel engine with preheated *Jatropha curcas* oil using waste heat from exhaust gas," *Fuel*, vol. 115, pp. 527–533, 2014, doi: 10.1016/j.fuel.2013.07.067.
- [34] H. Y. Nanlohy, "Comparative Studies on Combustion Characteristics of Blended Crude *Jatropha* Oil with Magnetic Liquid Catalyst and DEX under Normal Gravity Condition," *Journal of Mechanical Engineering Science and Technology*, vol. 5, no. 2, pp. 79–88, 2021, doi: 10.17977/um016v5i22021p079.
- [35] M. Ikegami, G. Xu, and K. Ikeda, "Distinctive combustion stages of single heavy oil droplet under microgravity," *Fuel*, vol. 82, pp. 293–304, 2003, doi: 10.1016/S0016-2361(02)00257-0.
- [36] K. Meng, W. Fu, Y. Lei, D. Zhao, Q. Lin, and G. Wang, "Study on micro-explosion intensity characteristics of biodiesel, RP-3 and ethanol mixed droplets," *Fuel*, vol. 256, no. August, 2019, doi: 10.1016/j.fuel.2019.115942.
- [37] H. Y. Nanlohy and H. Riupassa, "An Experimental Study on the Ignition Behavior of Blended Fuels Droplets with Crude Coconut Oil and Liquid Metal Catalyst," *Automotive Experiences*, vol. 3, no. 2, pp. 39–45, 2020, doi: 10.31603/ae.v3i2.3481.

# Effects of Eugenol and Cineol Compound on Diffusion Burning Rate Characteristics of Crude Coconut Oil Droplet

## ORIGINALITY REPORT

12%

SIMILARITY INDEX

10%

INTERNET SOURCES

11%

PUBLICATIONS

5%

STUDENT PAPERS

## PRIMARY SOURCES

1	<a href="http://journal.ummgl.ac.id">journal.ummgl.ac.id</a> Internet Source	3%
2	<a href="http://journal2.um.ac.id">journal2.um.ac.id</a> Internet Source	2%
3	Jusuf Haurissa, Helen Riupassa, Nevada JM. Nanulaitta, Trismawati, Hendry Y. Nanlohy. "Development of briquette stove to increase heating efficiency and flame stability of sago waste briquette", AIP Publishing, 2022 Publication	2%
4	La Kolo, Firdaus Firdaus, Paulina Taba, Muhammad Zakir, Nunuk Hariani Soekamto. "Selectivity of the New Catalyst ZnO-MCM-48-CaO in Esterification of Calophyllum inophyllum Oil", Automotive Experiences, 2022 Publication	1%
5	<a href="http://www.cell.com">www.cell.com</a> Internet Source	1%

6	Ena Marlina, Hendry Y. Nanlohy, I Gusti Ketut Puja, Helen Riupassa. "Droplet combustion behavior of crude palm oil-carbon nanoparticles blends", IOP Conference Series: Materials Science and Engineering, 2021 Publication	1 %
7	Hendry Y. Nanlohy, I.N.G. Wardana, Nurkholis Hamidi, Lilis Yuliati, Toshihisa Ueda. "The effect of Rh 3+ catalyst on the combustion characteristics of crude vegetable oil droplets", Fuel, 2018 Publication	1 %
8	edoc.site Internet Source	1 %
9	Submitted to Universitas Sebelas Maret Student Paper	1 %
10	ndl.ethernet.edu.et Internet Source	1 %
11	www.ojs.upj.ac.id Internet Source	1 %

Exclude quotes  Off  
Exclude bibliography  On

Exclude matches  < 1%